

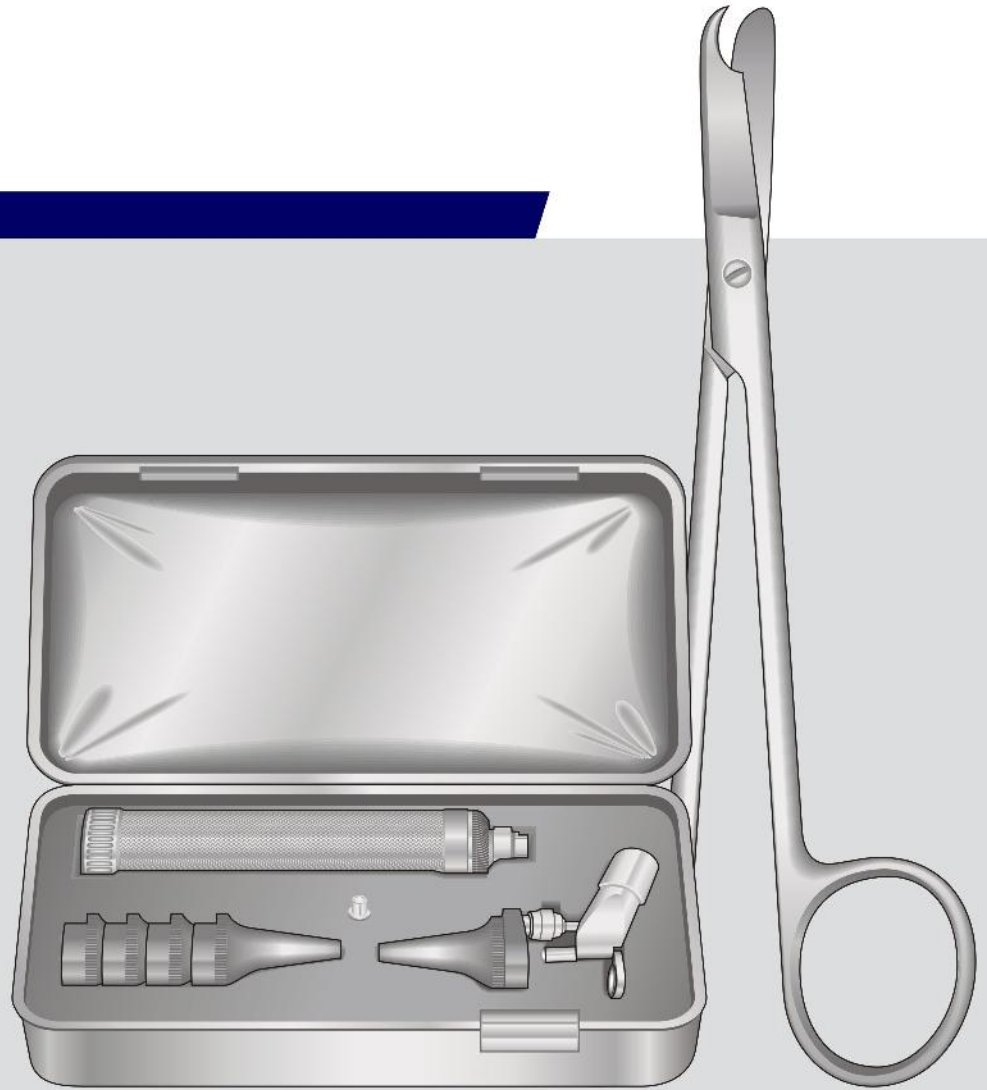

**INTERNATIONAL**

LET'S SHARE ABOUT SURGERY



# *General Surgery Instruments*

**Surgical  
Instruments  
Catalogue**



[www.ssqintl.com](http://www.ssqintl.com)

Diagnostik-Bestecke - Diagnostic Sets  
Set Diagnostica - Set Diagnóstico  
Trousse à Diagnostic

Halogen - Alogeno



SSQ-4301  
Otoscopio completo con custodia

Etui für McINTOSH Fig. 1-3  
Case for McINTOSH Fig. 1-3  
Cassetta per laringoscopio McINTOSH Fig. 1-3  
Estuche para McINTOSH Fig. 1-3  
Etui pour McINTOSH Fig. 1-3



SSQ-4302

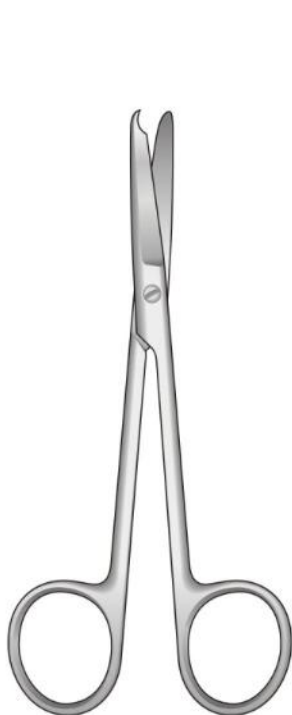

SPENCER  
SSQ-4303  
120 mm

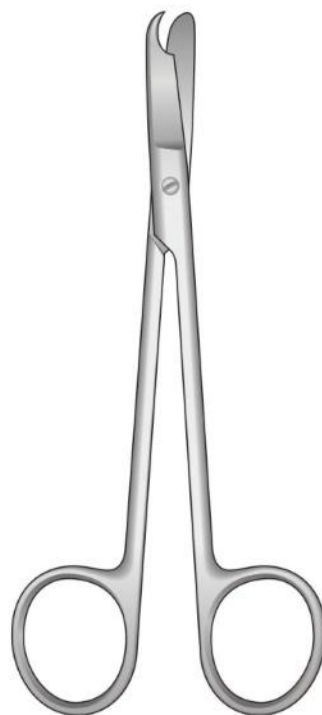

LITTAUER  
SSQ-4304  
140 mm

Wellenschliff  
TC

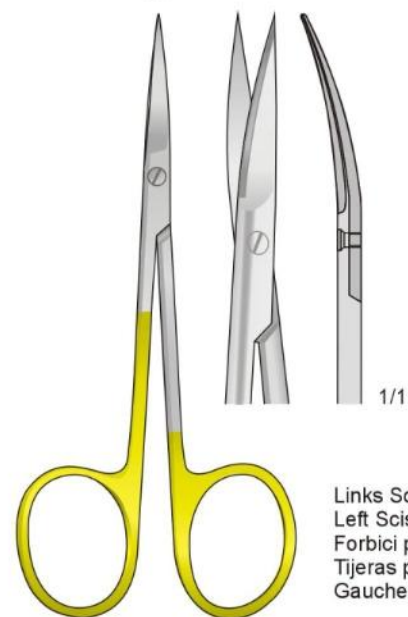

IRIS  
SSQ-4305  
110 mm

Links Scheren  
Left Scissors  
Forbici per mancini  
Tijeras para zurdos  
Gauche Ciseaux

**"Ribbon type"**

Mit großen Ringen  
With large rings  
Forbici ad anelli grandi  
Con anillos especialmente grandes  
avec larges anneaux

Iris scissors

Blepharoplasty  
Blefaroplastica

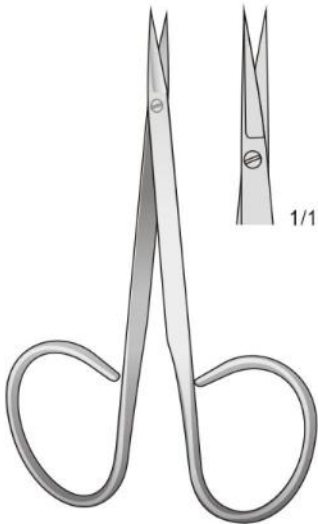

SSQ-4306  
95 mm

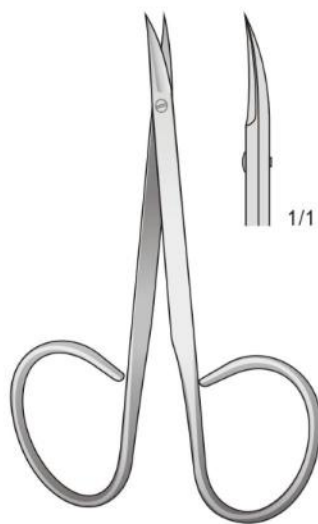

SSQ-4307  
95 mm

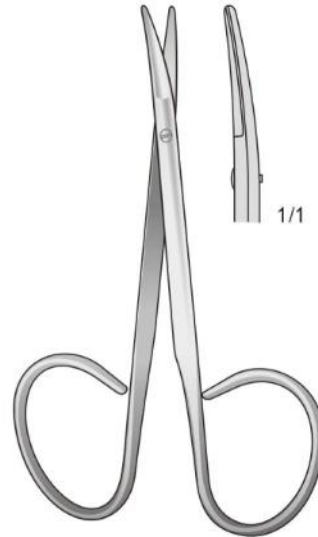

SSQ-4308  
95 mm

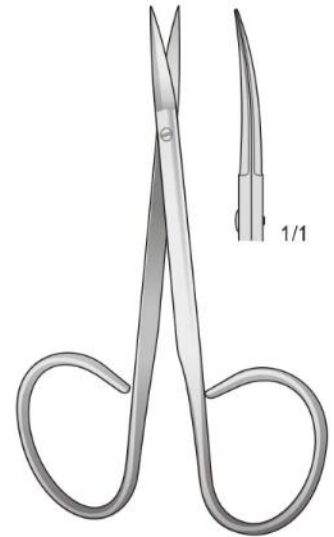

SSQ-4309  
105 mm

Iris scissors

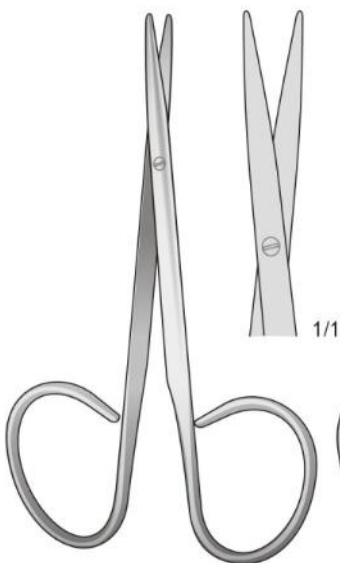

SSQ-4310  
100 mm

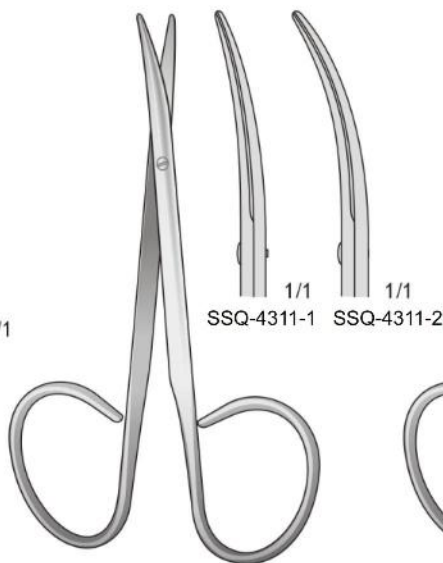

SSQ-4311  
100 mm

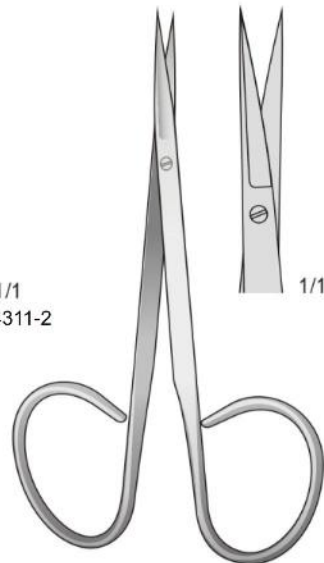

SSQ-4312  
105 mm

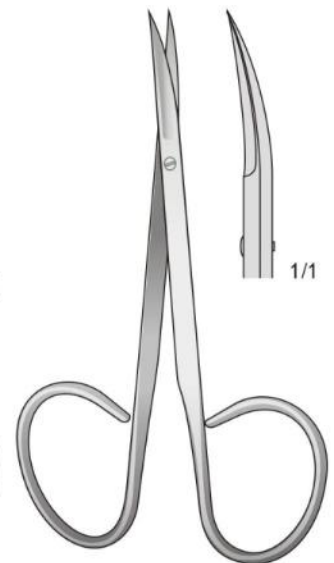

SSQ-4313  
105 mm

**"Ribbon type"**

Mit großen Ringen  
With large rings  
Forbici ad anelli grandi  
Con anillos especialmente grandes  
avec larges anneaux

Spitz  
Sharp  
Acuta  
Aguda  
Pointu

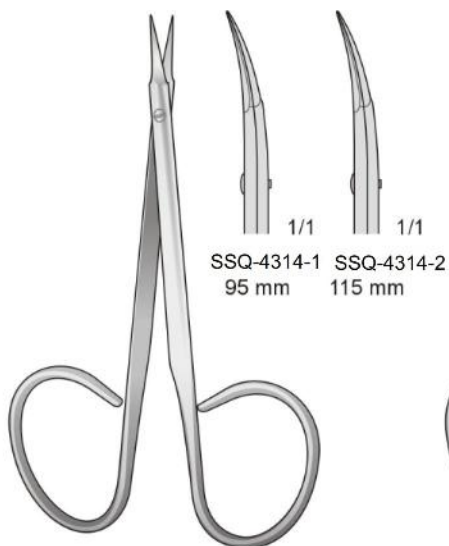

SSQ-4314-1 95 mm  
SSQ-4314-2 115 mm

SSQ-4314  
STITCH

Stumpf  
Blunt  
Smussa  
Romas  
Mousse

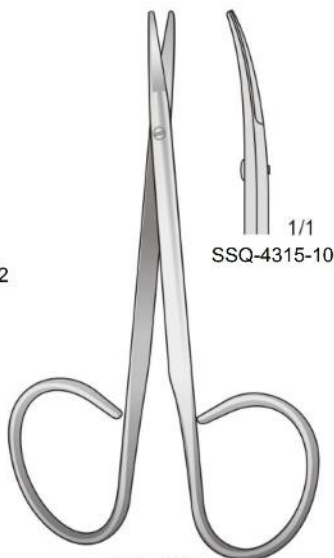

SSQ-4315-10

SSQ-4315  
100 mm

Gezahnt  
Serrated  
Dentellata  
Dentadas  
Dentelés

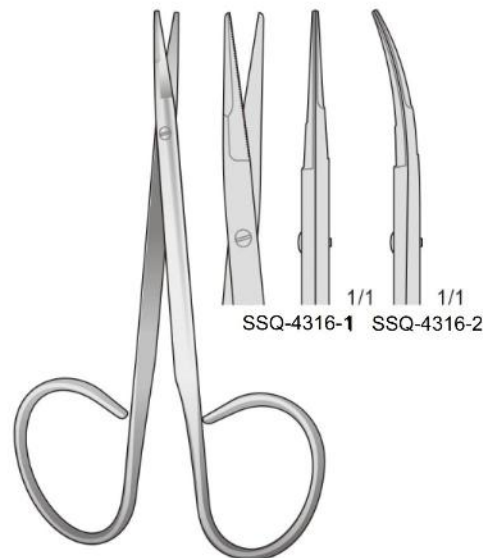

SSQ-4316-1  
SSQ-4316-2

KAYE  
SSQ-4316  
105 mm

Stumpf - Blunt  
Smussa - Romas  
Mousse

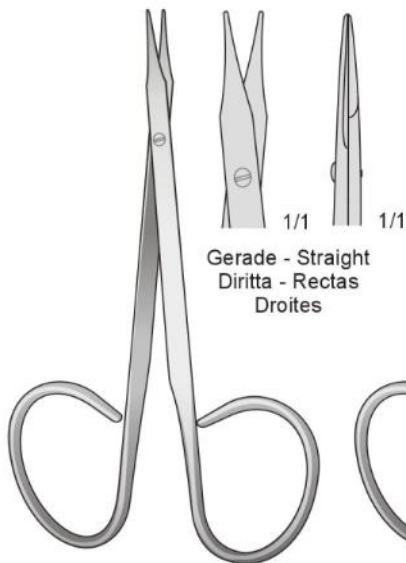

Gerade - Straight  
Diritta - Rectas  
Droites

STEVENS  
SSQ-4317  
100 mm

Stumpf - Blunt  
Smussa - Romas  
Mousse

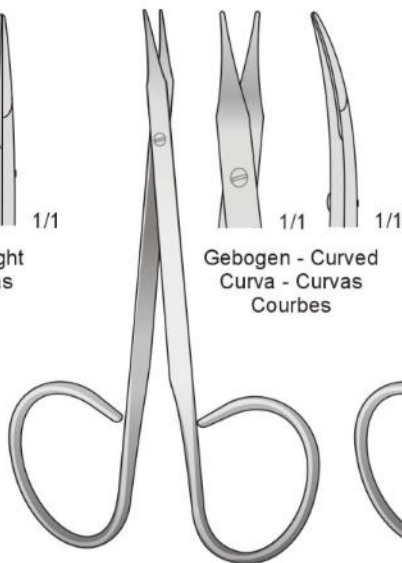

Gebogen - Curved  
Curva - Curvas  
Courbes

STEVENS  
SSQ-4318  
100 mm

Spitz - Sharp  
Acuta - Aguda  
Pointu

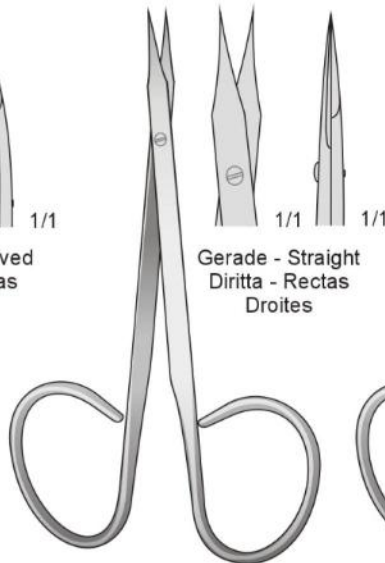

Gerade - Straight  
Diritta - Rectas  
Droites

WALTON  
SSQ-4319  
100 mm

Spitz - Sharp  
Acuta - Aguda  
Pointu

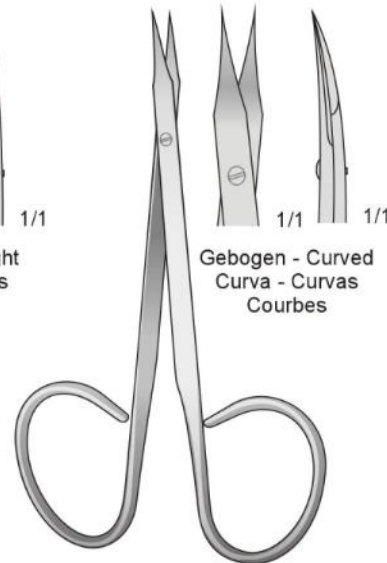

Gebogen - Curved  
Curva - Curvas  
Courbes

WALTON  
SSQ-4320  
100 mm

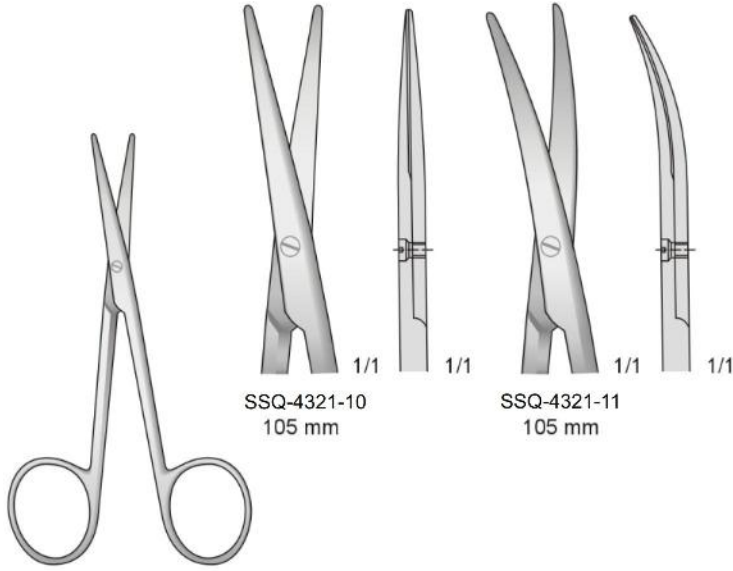

COTTLE-KNAPP  
SSQ-4321  
105 mm

COTTLE  
SSQ-4322  
115 mm

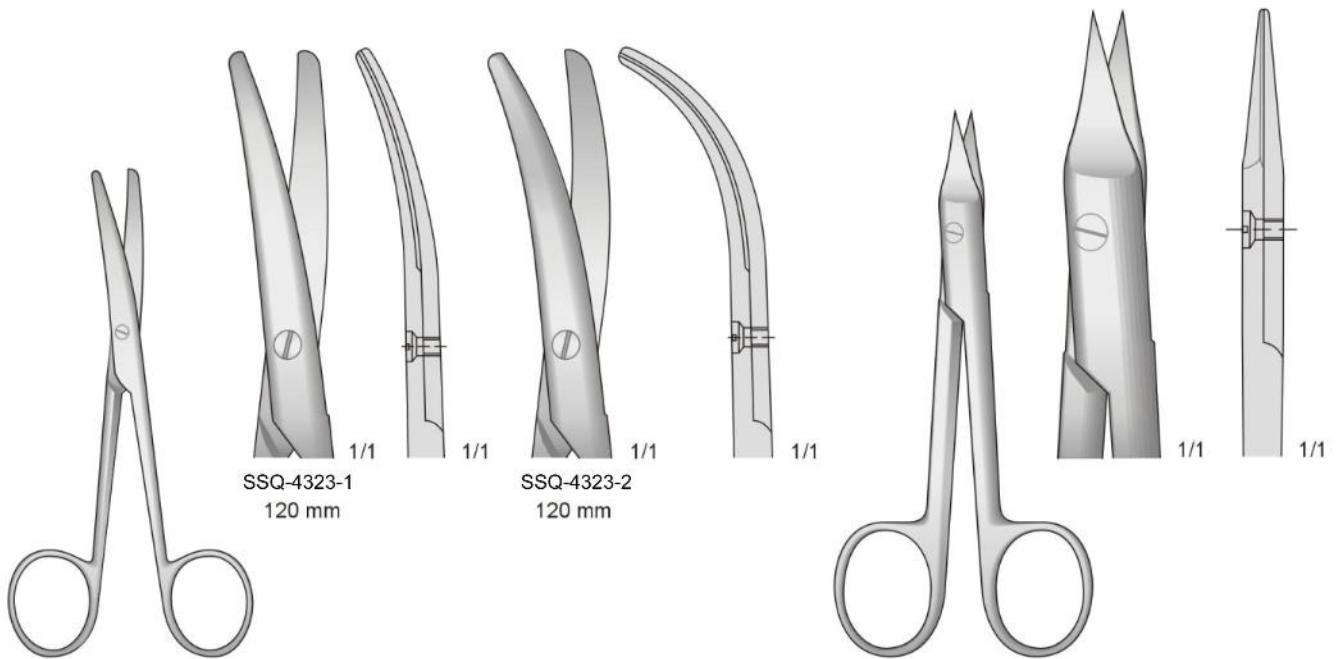

LANDOLT  
SSQ-4323  
120 mm

SYSTRUNK  
SSQ-4324  
130 mm

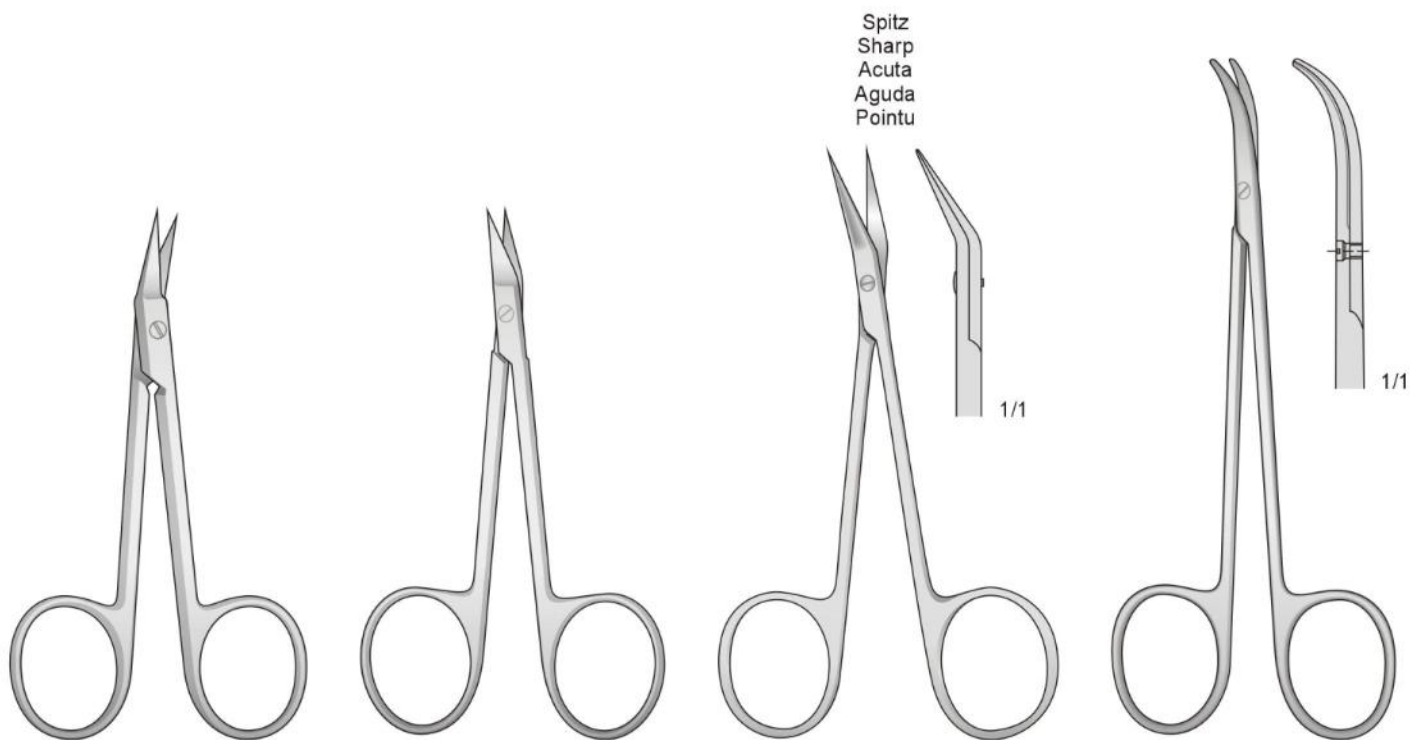

O'BRIEN  
SSQ-4325  
95 mm

DANIELS  
SSQ-4326  
90 mm

BIRO  
SSQ-4327  
100 mm

CINELLI  
SSQ-4328  
115 mm

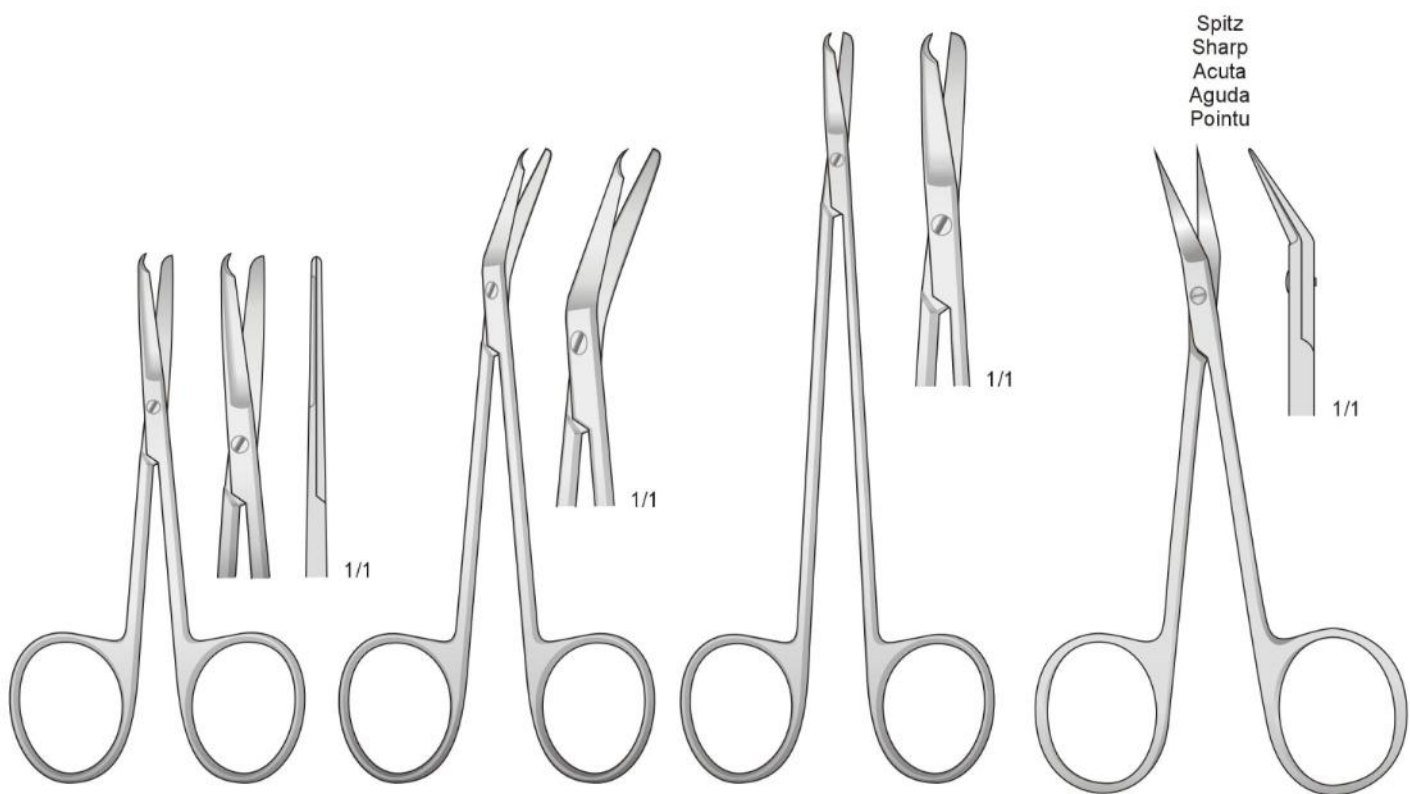

SPENCER  
SSQ-4329  
90 mm

SPENCER  
SSQ-4330  
130 mm

KELLY  
SSQ-4331  
150 mm

WILMER  
SSQ-4332  
105 mm



SSQ-4333  
THOREK

SSQ-4333-1  
190 mm

SSQ-4333-2  
230 mm

SSQ-4333-3  
250 mm



SHEA  
SSQ-4334  
120 mm

FOMON  
SSQ-4335  
135 mm

WALTON  
SSQ-4336  
165 mm

JORGENSEN  
SSQ-4337  
230 mm

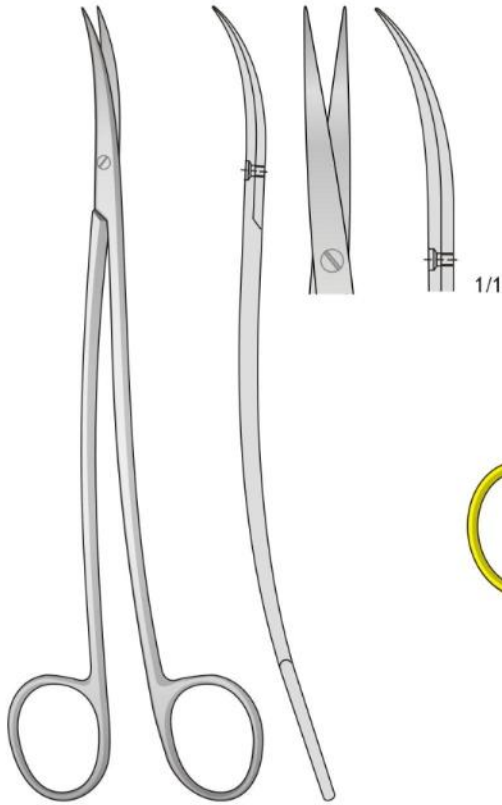

**METZENBAUM-FINO**  
SSQ-4338-1 - 180 mm  
SSQ-4339-2 - 200 mm  
SSQ-4340-3 - 230 mm

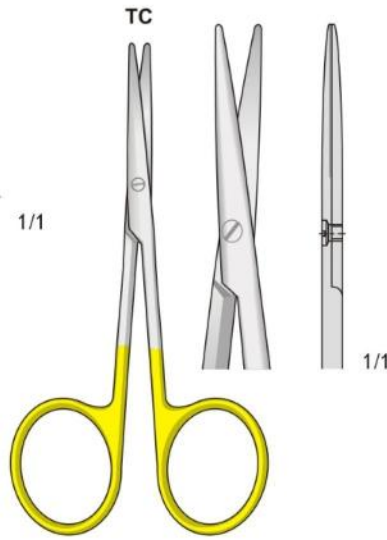

**LEXER-BABY**  
SSQ-4341  
100 mm

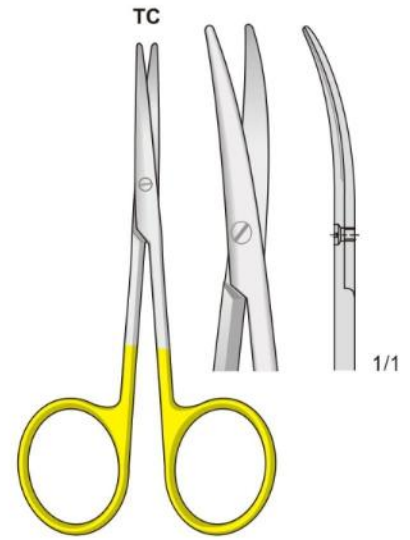

**LEXER-BABY**  
SSQ-4342  
100 mm

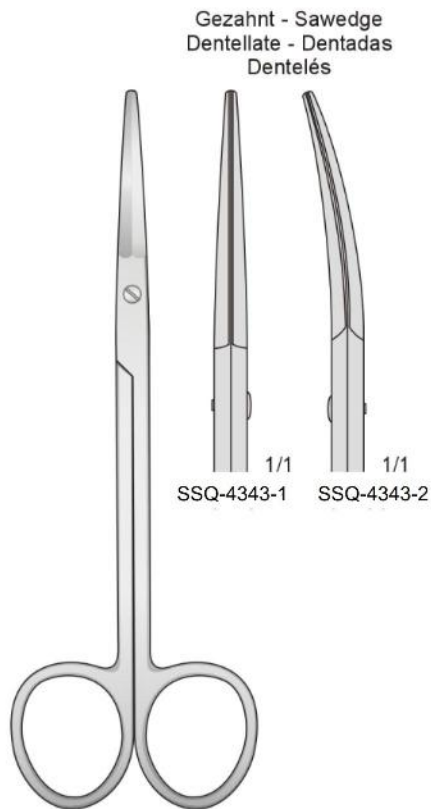

**KAHN**  
SSQ-4343  
145 mm

Gezahnt - Sawedge  
Dentellate - Dentadas  
Dentelés

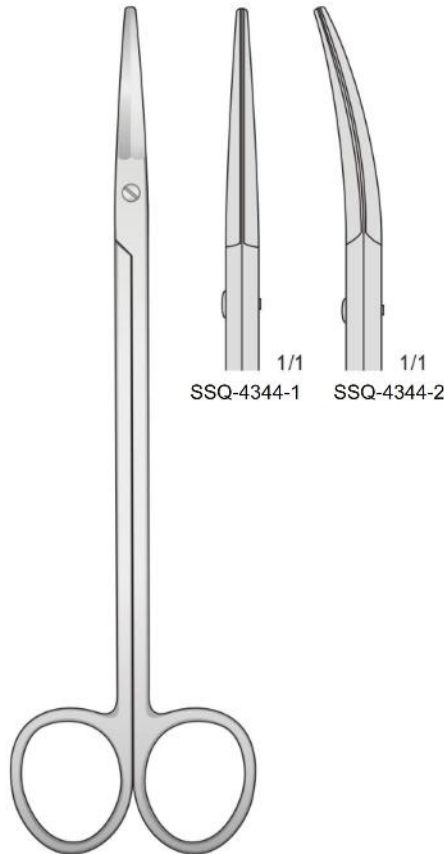

**KAHN**  
SSQ-4344  
180 mm

Gezahnt - Sawedge  
Dentellate - Dentadas  
Dentelés

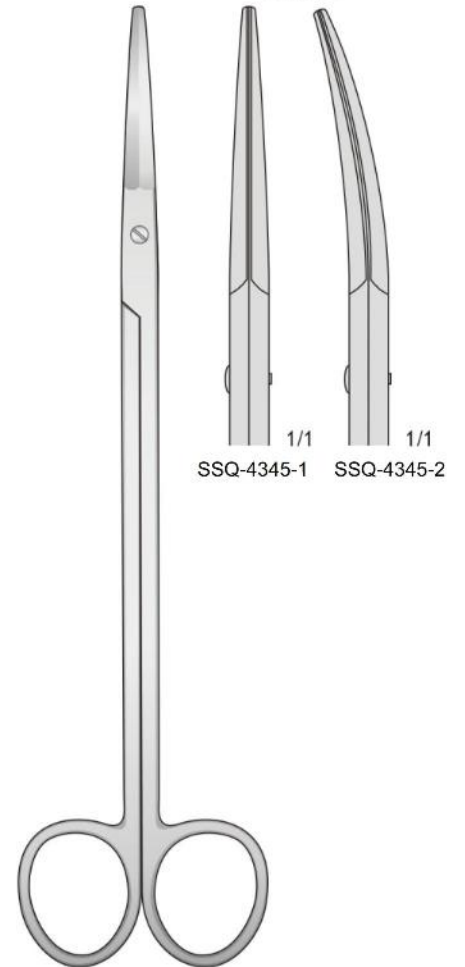

**KAHN**  
SSQ-4345  
205 mm



Eine Schneide gezahnt S-förmig gebogen  
One toothed cutting edge S-shaped  
Una lama dentata curva a forma S  
Una hoja dentada forma S  
Une lame dentelée courbés en S

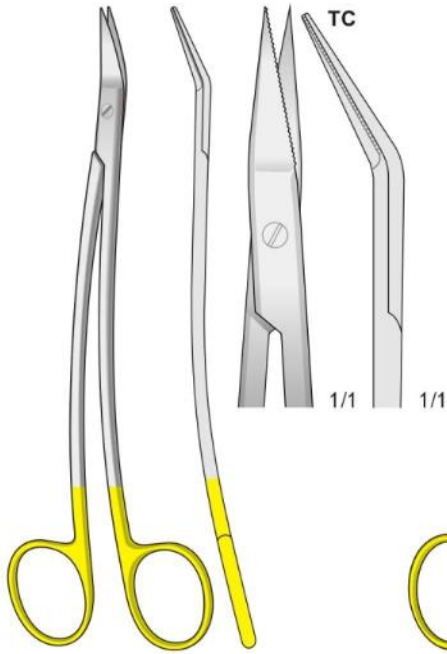

SSQ-4346  
175 mm

TC

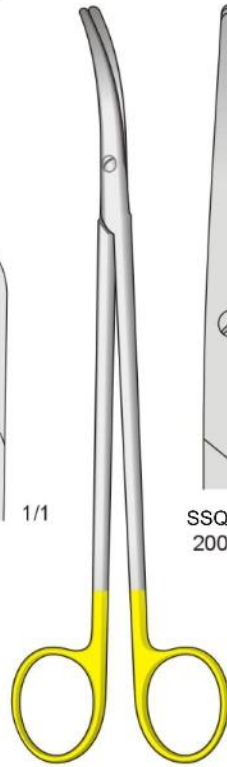

METZENBAUM-THOREK  
SSQ-4347

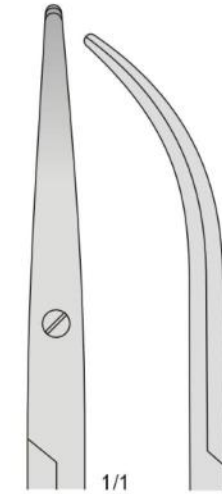

SSQ-4348-1  
200 mm

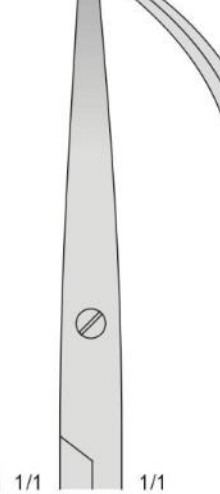

SSQ-4348-2  
230 mm

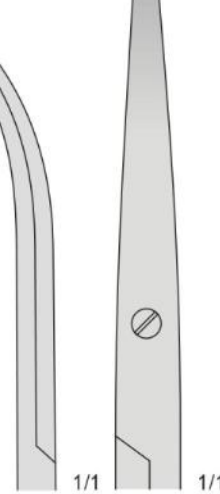

SSQ-4348-3  
280 mm

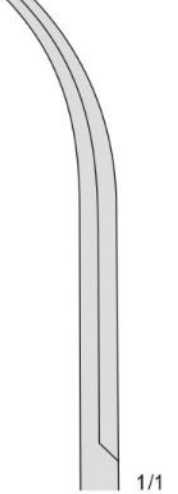

SSQ-4350-1  
1/1

TC

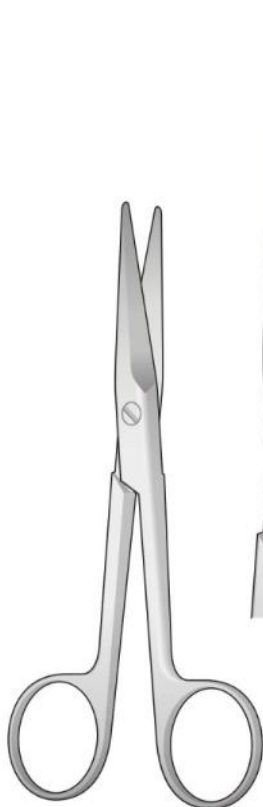

MAYO  
SSQ-4349  
155 mm



SSQ-4349-1  
1/1



SSQ-4349-2  
1/1

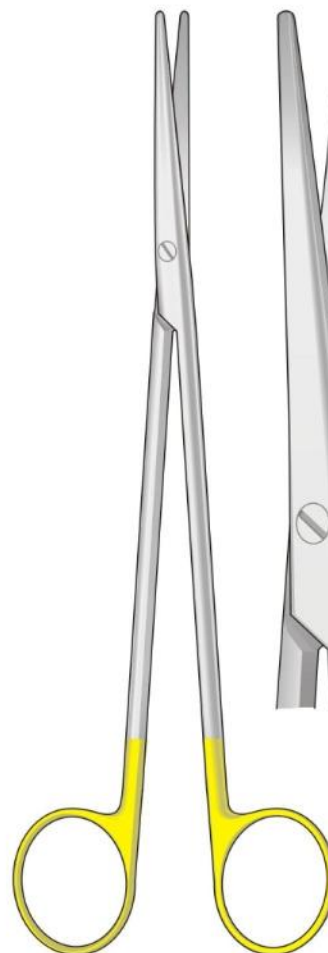

METZENBAUM  
SSQ-4350  
280 mm

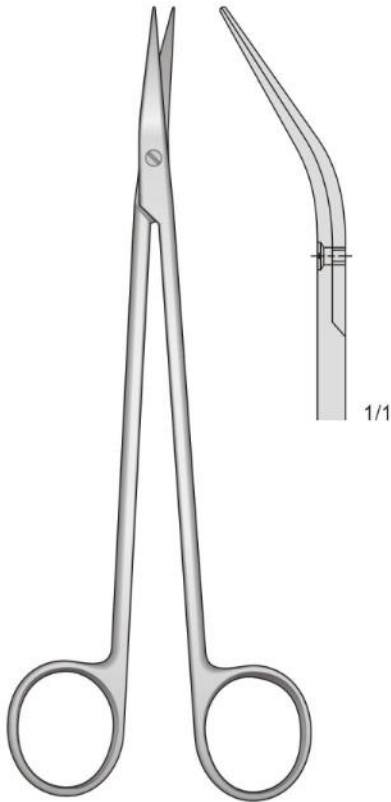

POTTS-SMITH  
SSQ-4352  
175 mm

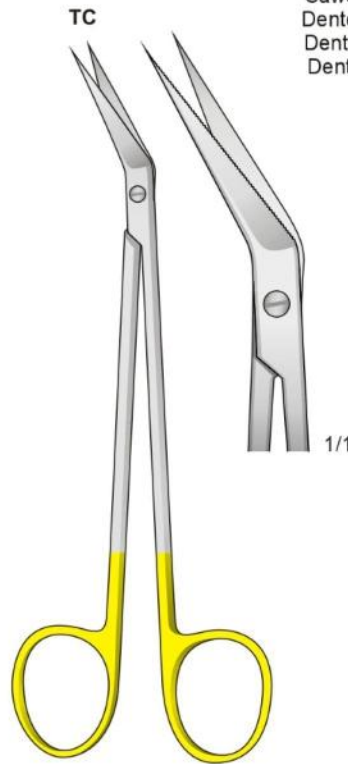

SSQ-4353  
160 mm

Gezahnt  
Sawedge  
Dentellate  
Dentadas  
Dentelés

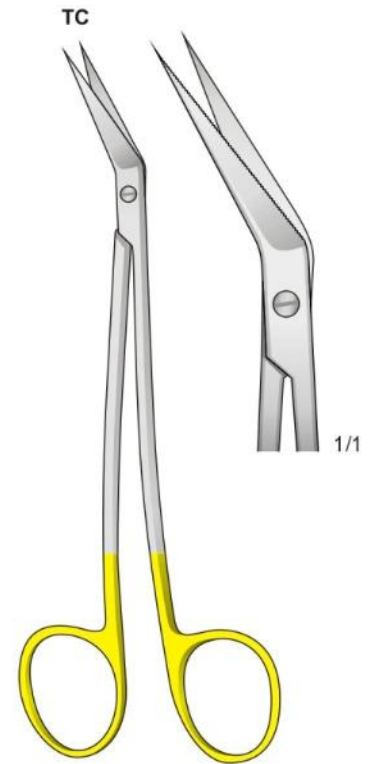

SSQ-4354  
160 mm

Gefäßscheren  
Vessel scissors

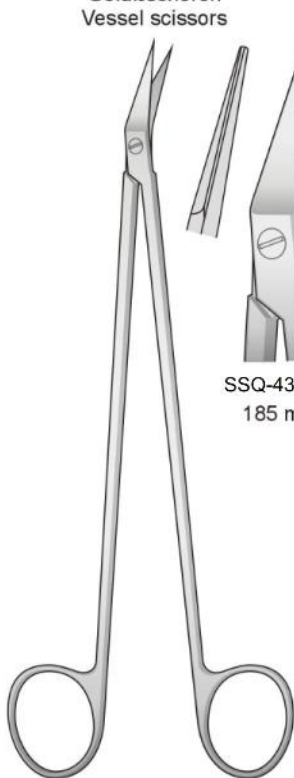

POTTS-DE MARTEL  
SSQ-4354  
185 mm

30°



SSQ-4354-1  
185 mm

45°



SSQ-4354-2  
185 mm

60°



SSQ-4354-3  
185 mm

Coronararterien-Schere  
Coronary artery scissors

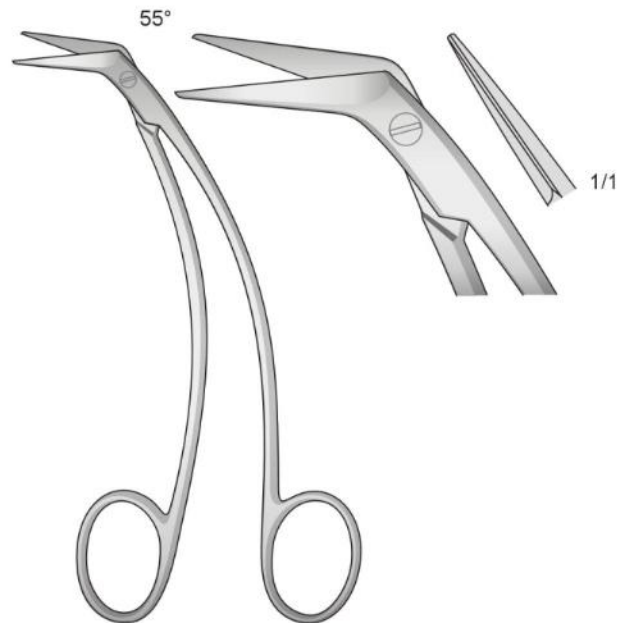

FAVOLORO  
SSQ-4355  
140 mm

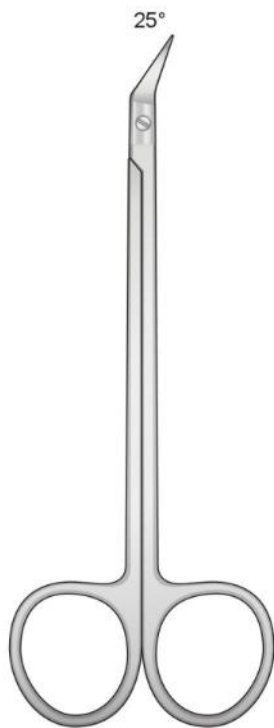

SSQ-4356  
135 mm

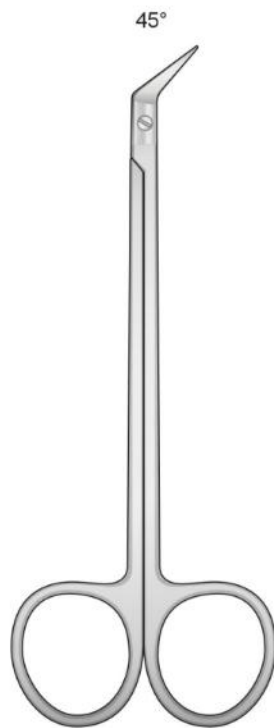

SSQ-4357  
135 mm

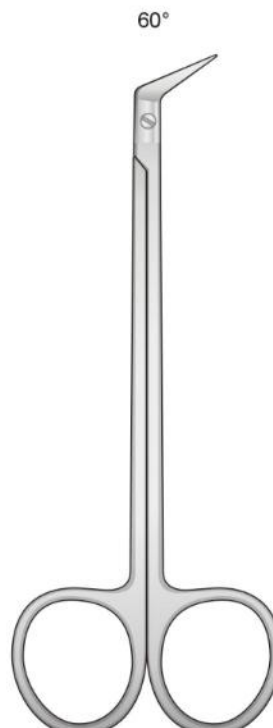

SSQ-4358  
135 mm

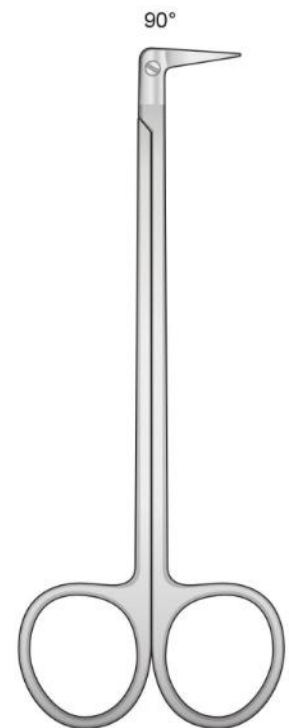

SSQ-4359  
135 mm

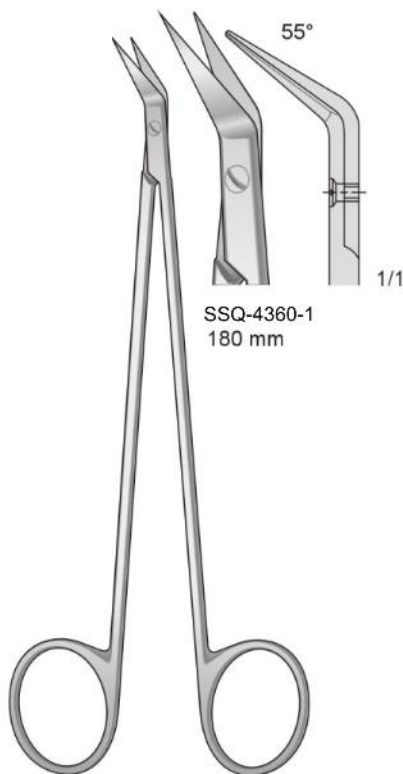

SSQ-4360-1  
180 mm

POTTS-SMITH  
SSQ-4360  
180 mm

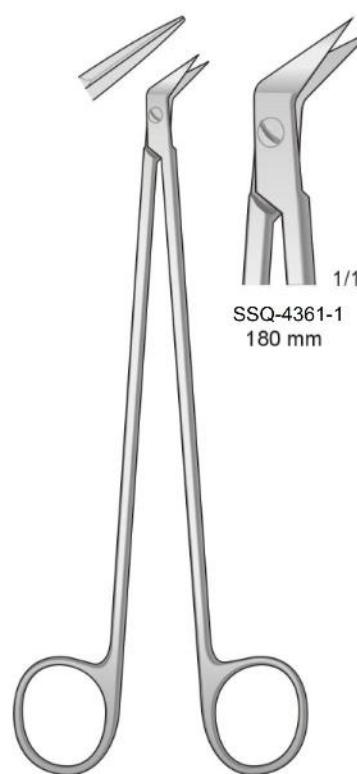

SSQ-4361-1  
180 mm

POTTS-SMITH  
SSQ-4361  
180 mm

Gezahnt - Serrated  
Dentellata - Dentadas  
Dentelés

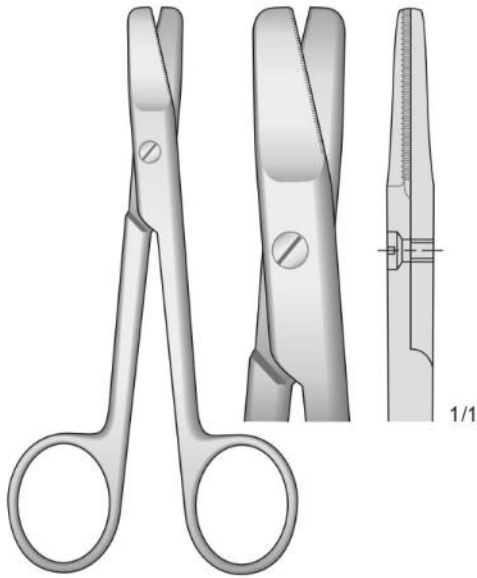

**HARVEY**  
SSQ-4362  
125 mm

Spitz - Sharp  
Acuta - Agudo - Aigu



**METZENBAUM**  
SSQ-4363  
145 mm

Kapselschere  
Forbice da cartilagine  
Cartilage Scissors

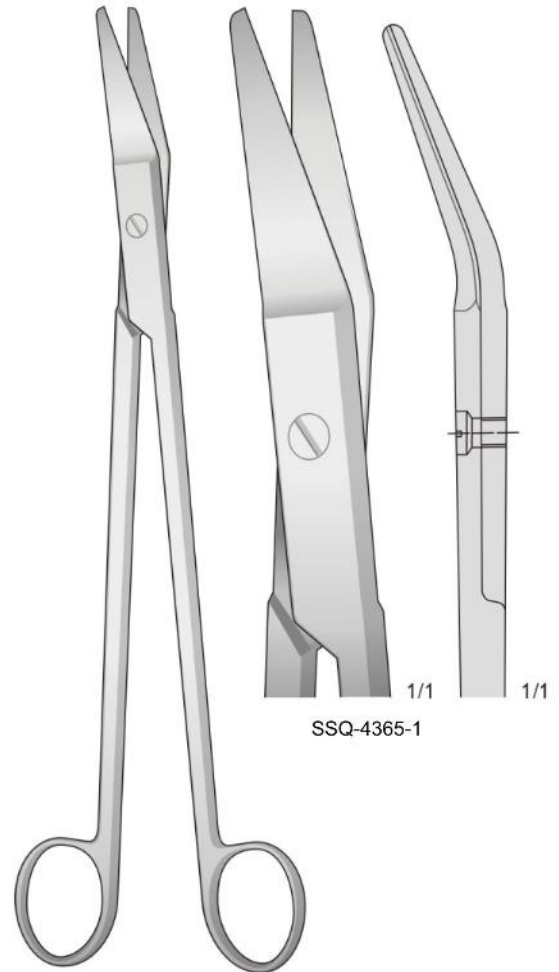

**RESANO**  
SSQ-4365  
250 mm

Uterusschere  
Uterine scissors



**BOZEMANN**  
SSQ-4364  
220 mm

Gezahnt - Serrated  
Dentellata - Dentadas - Dentées

TC

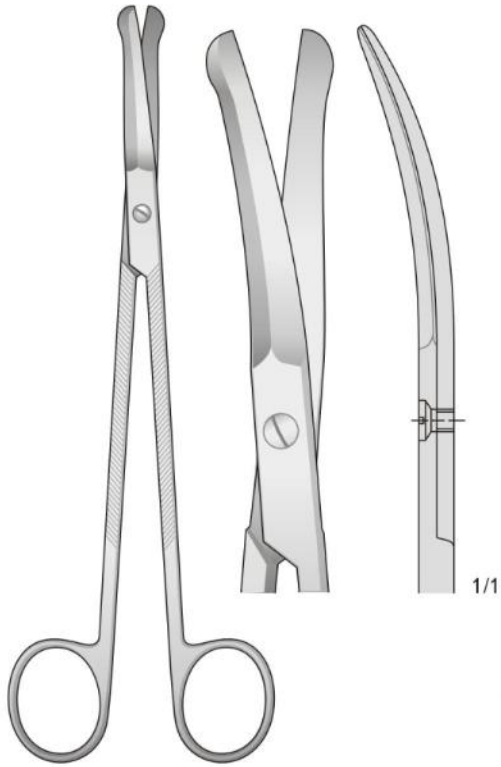

GOOD  
SSQ-4366  
195 mm

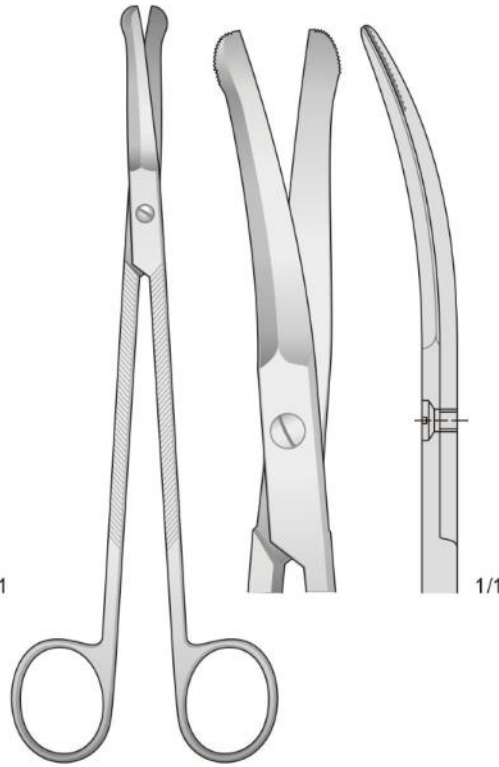

SCHWECKENDIEK  
SSQ-4367  
195 mm

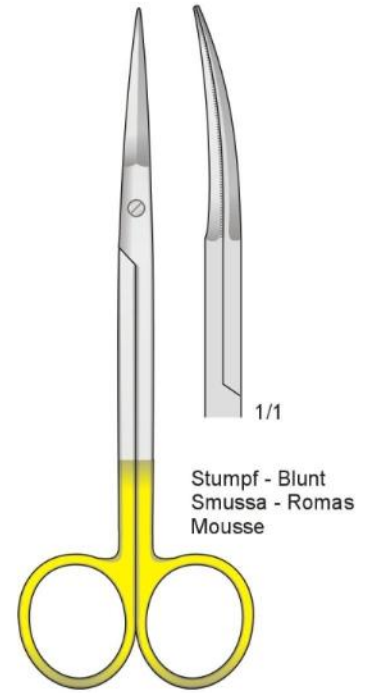

PECK-JOSEPH  
SSQ-4368  
140 mm

Stumpf - Blunt  
Smussa - Romas  
Mousse

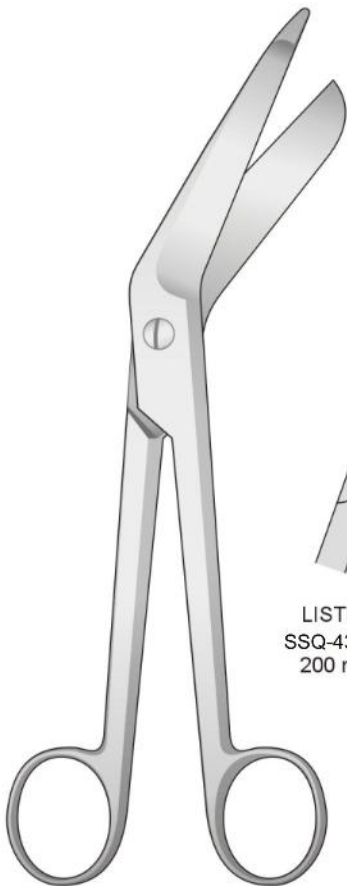

LISTER  
SSQ-4369-1  
200 mm

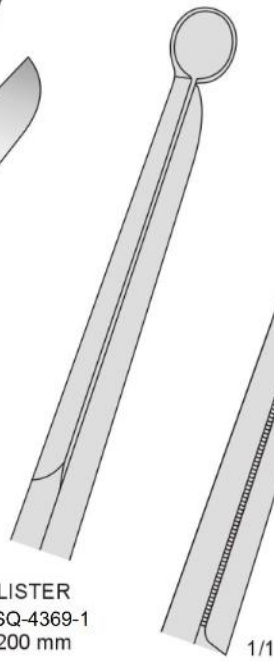

BERGMANN  
SSQ-4369-2  
230 mm

TC

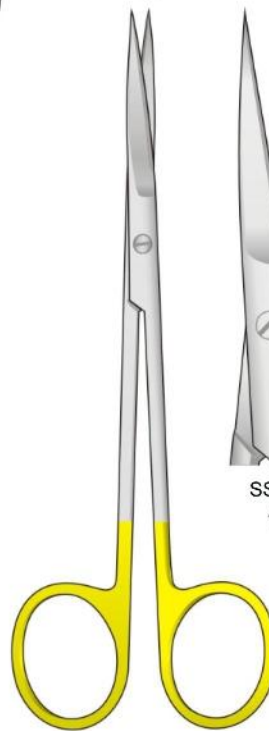

JOSEPH  
SSQ-4370  
150 mm

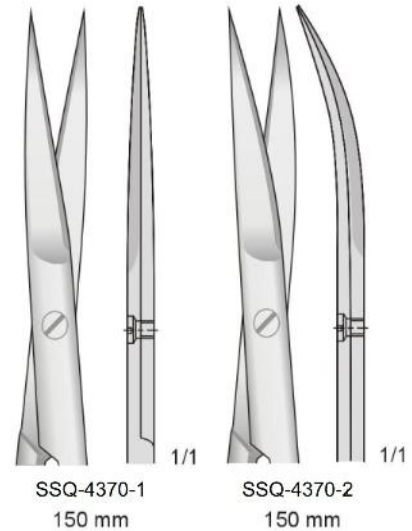

SSQ-4370-1  
150 mm

SSQ-4370-2  
150 mm

SSQ-4369

"Super-cut" scheren micro-schliff für tissue atrauma  
 "Super-cut" scissors for gripping tissue and cutting interproximally  
 Forbici "super-cut" estremamente taglienti per tessuti con riduzione del trauma  
 Tijeras "super cortes" para cortar tissue-atrauma  
 Ciseaux "super cut" coupe les tissus en reduisant les risques de traumatisme

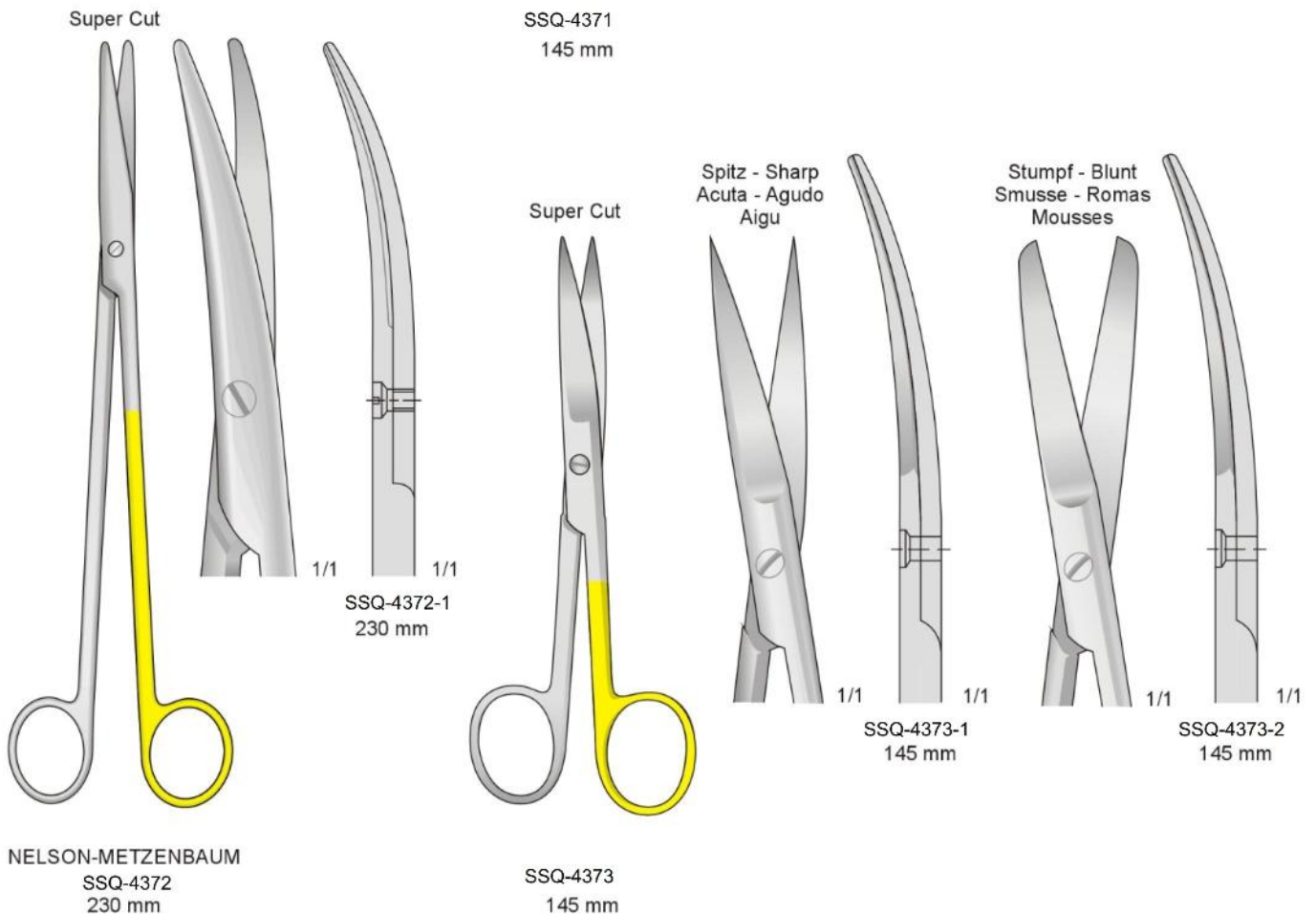
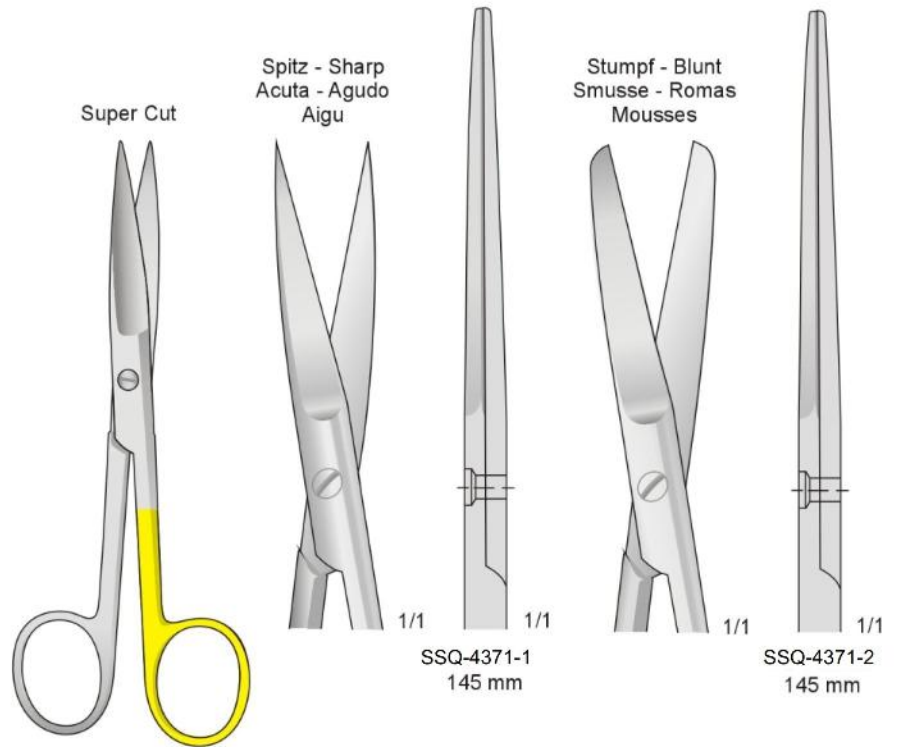

Mit Hartmetalleinsätzen  
Tungsten-carbide scissors  
Con punta al carburo di tungsteno  
Tijeras de tungsteno  
Avec plaquettes en carbure de tungstène

Mit eine Schneide gezahnt  
With one blade serrated  
Con una lama zigrinata  
Con una hoja dentada  
Avec lame dentèle

Super Cut  
TC

Mit eine Schneide gezahnt  
With one blade serrated  
Con una lama zigrinata  
Con una hoja dentada  
Avec lame dentèle

Super Cut  
TC

Mit eine Schneide gezahnt  
With one blade serrated  
Con una lama zigrinata  
Con una hoja dentada  
Avec lame dentèle

Super Cut  
TC

Mit eine Schneide gezahnt  
With one blade serrated  
Con una lama zigrinata  
Con una hoja dentada  
Avec lame dentèle

Super Cut

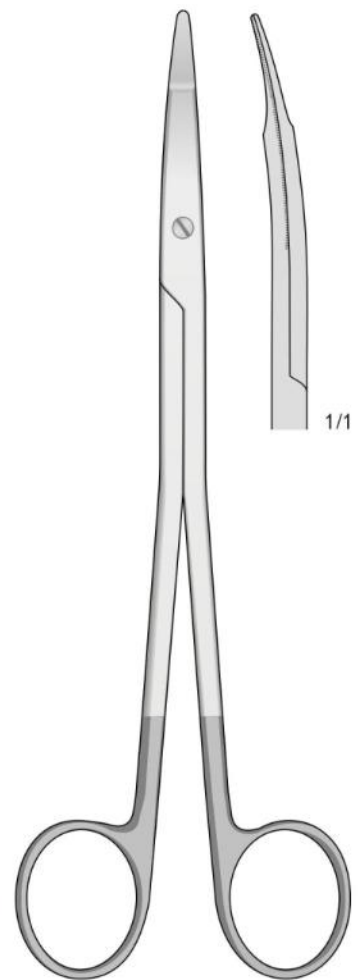
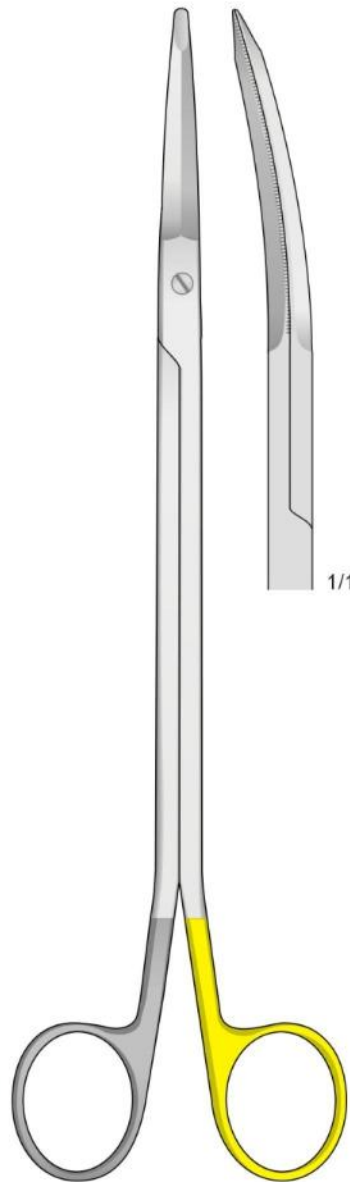
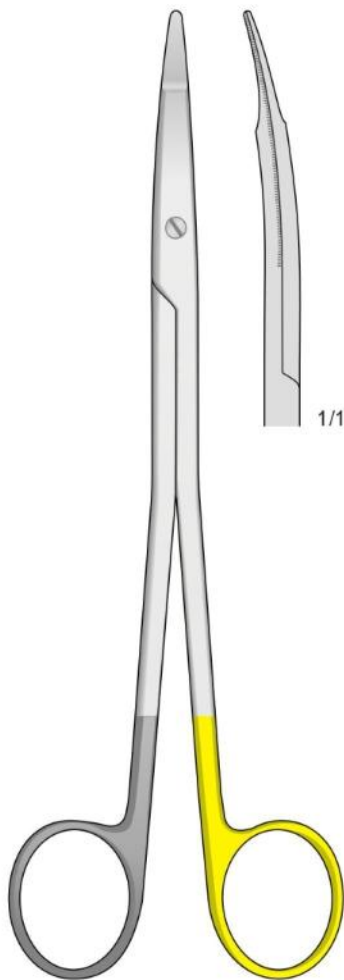
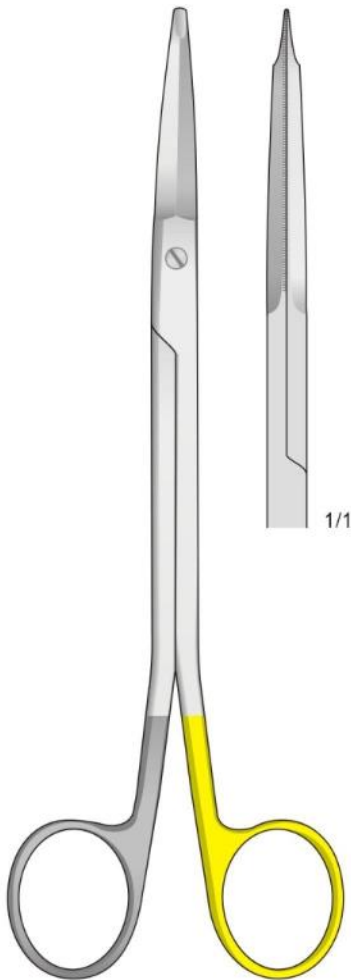

FREEMAN GORNEY  
SSQ-4374  
180 mm

FREEMAN  
SSQ-4375  
180 mm

GORNEY  
SSQ-4376  
230 mm

FREEMAN  
SSQ-4377  
180 mm

Mit Hartmetalleinsätzen  
Tungsten-carbide scissors  
Con punta al carburo di tungsteno  
Tijeras de tungsteno  
Avec plaquettes en carbure de tungstène

Mit eine Schneide gezahnt  
With one blade serrated  
Con una lama zigrinata  
Con una hoja dentada  
Avec lame dentèle

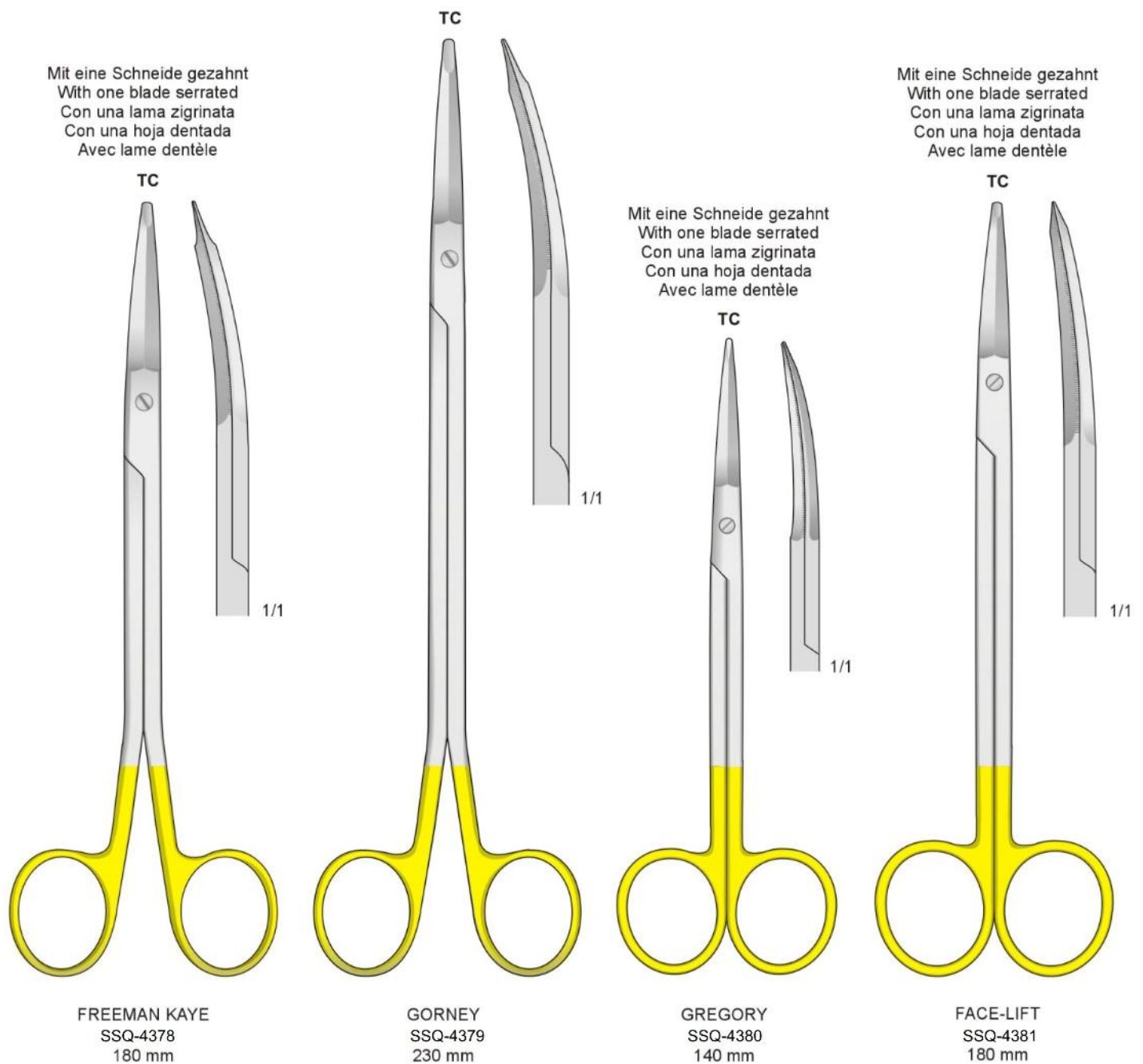



Pinzette mit Häkchen  
Suturing Forceps  
Pinzette per suture

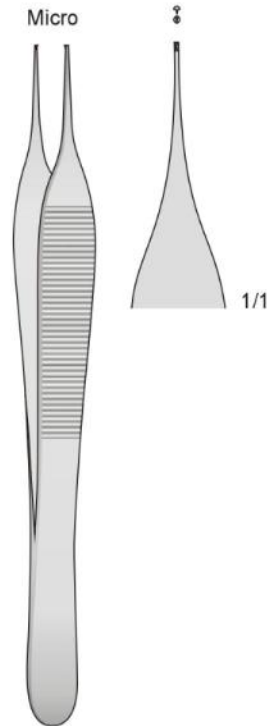

ADSON  
SSQ-4382  
150 mm

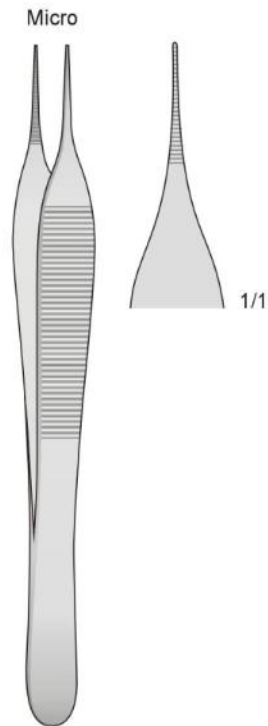

ADSON  
SSQ-4383  
150 mm



ADSON  
SSQ-4384  
125 mm

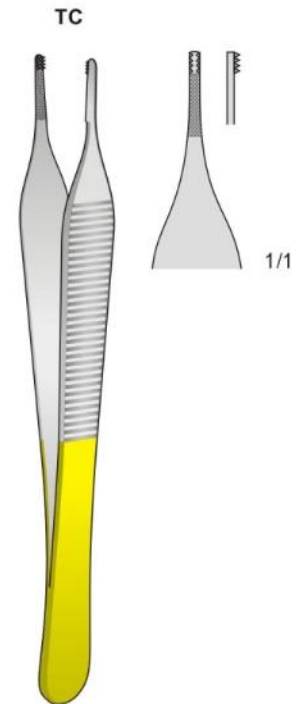

ADSON-BROWN  
SSQ-4385  
120 mm

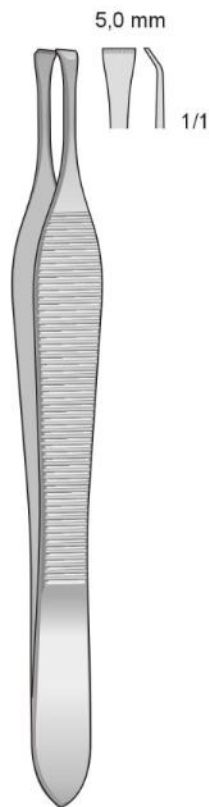

BEASLEY-BABCOCK  
SSQ-4386  
120 mm

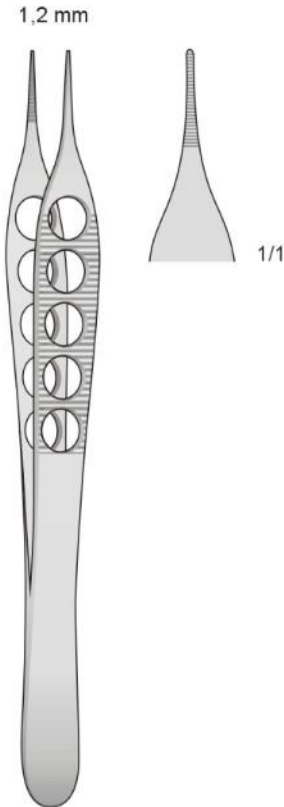

ADSON  
SSQ-4387  
120 mm

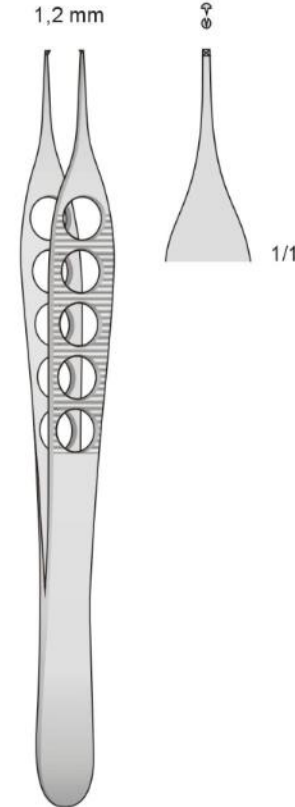

ADSON  
SSQ-4388  
120 mm

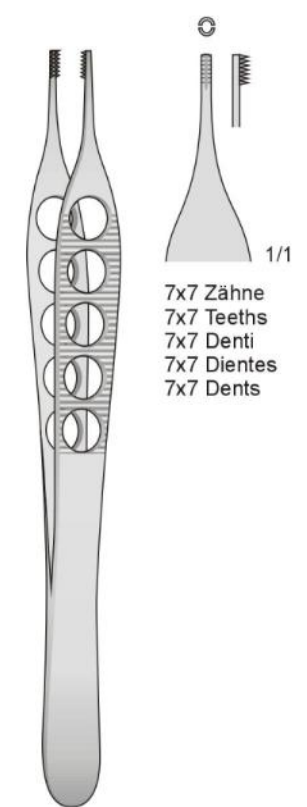

ADSON-BROWN  
SSQ-4389  
120 mm

7x7 Zähne  
7x7 Teeth  
7x7 Denti  
7x7 Dientes  
7x7 Dents

<p>TC</p>	<p>Mikroprofil - Micro profile Profilo micro - Perfil micro - Profil micro 2.0 mm</p> <p>SSQ-4390-1 160 mm    SSQ-4390-2 200 mm    SSQ-4390-3 245 mm</p>	<p>TC</p>	<p>1/1    1/1</p> <p>SSQ-4391-1 175 mm    SSQ-4391-2 175 mm</p> <p>1x2 Zähne 1x2 Teeth 1x2 Denti 1x2 Dientes 1x2 Dents</p>	<p>1/1</p> <p>SSQ-4392-1 180 mm</p> <p>1x2 Zähne 1x2 Teeth 1x2 Denti 1x2 Dientes 1x2 Dents</p>	
<p>DE BAKEY SSQ-4390</p>		<p>GERALD SSQ-4391 175 mm</p>		<p>BONNEY SSQ-4392 180 mm</p>	
	<p>1/1    1/1</p> <p>SSQ-4393-1 150 mm    SSQ-4393-2 150 mm</p>		<p>1/1    1/1</p> <p>SSQ-4394-1 150 mm    SSQ-4394-2 150 mm</p>		<p>1/1    1/1    1/1</p> <p>SSQ-4395-1 150 mm    SSQ-4395-2 150 mm    SSQ-4395-3 175 mm</p> <p>1x2 Zähne    2x3 Zähne    1x2 Zähne 1x2 Teeth    2x3 Teeth    1x2 Teeth 1x2 Denti    2x3 Denti    1x2 Denti 1x2 Dientes    2x3 Dientes    1x2 Dientes 1x2 Dents    2x3 Dents    1x2 Dents</p>
<p>McINDOE SSQ-4393 150 mm</p>		<p>GILLIES SSQ-4394 150 mm</p>		<p>LANE SSQ-4395</p>	

Titan - Titanium - Titano - Titane

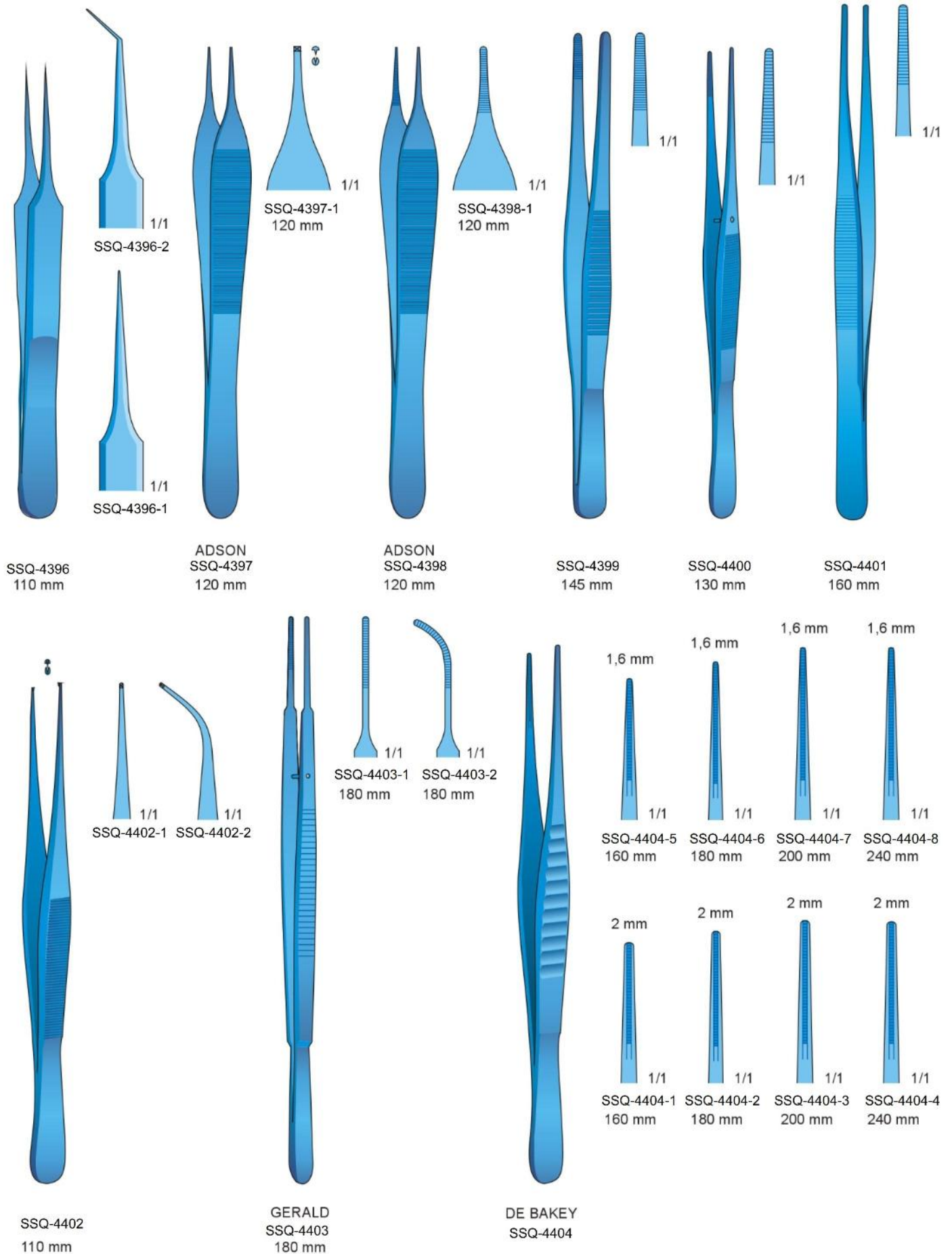

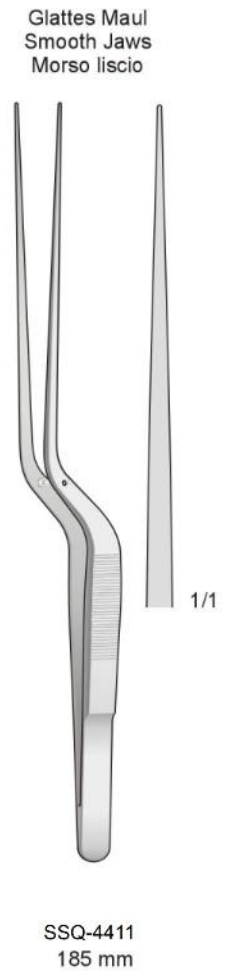
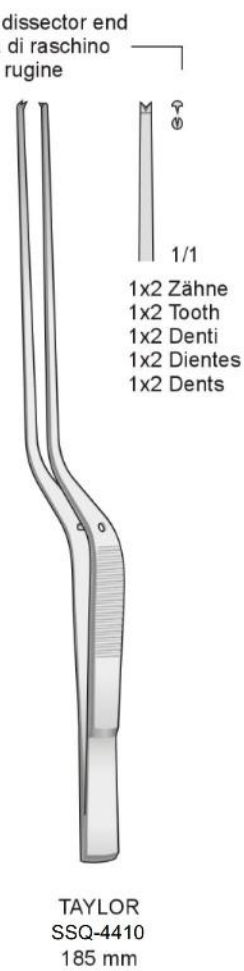
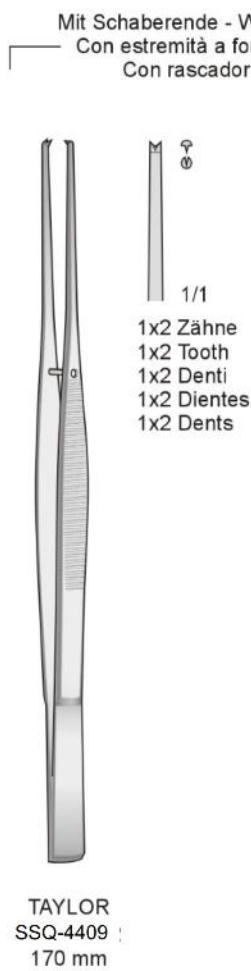
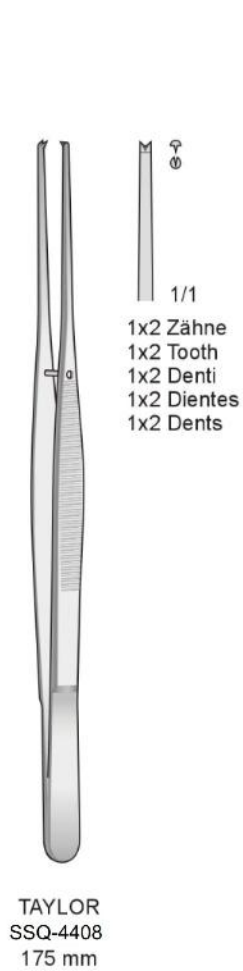
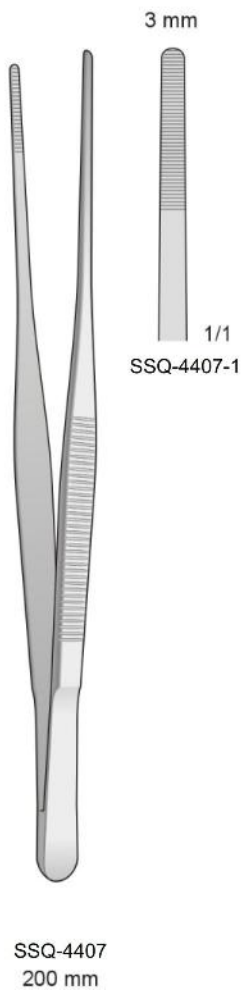
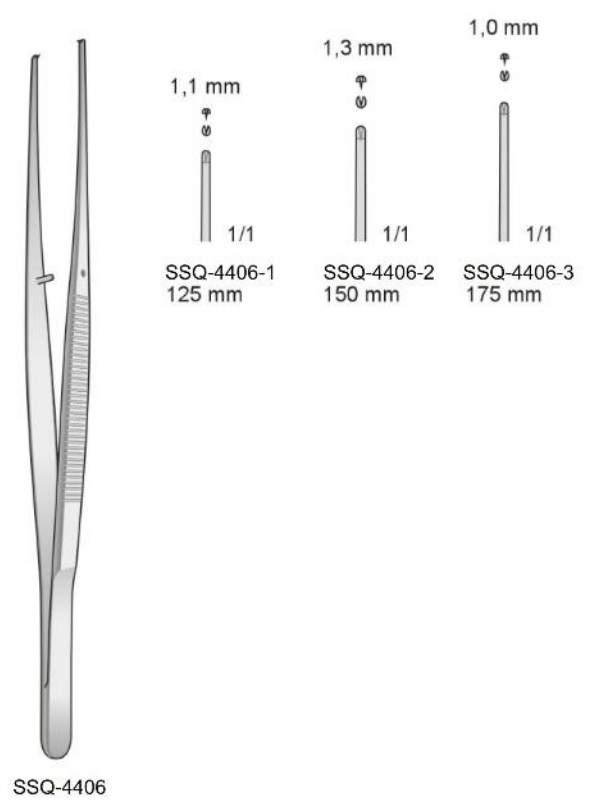
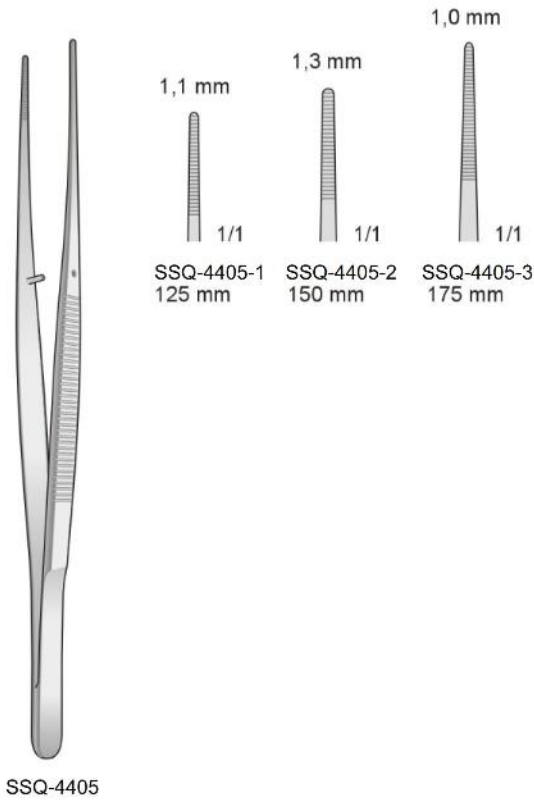

Isoliert - Insulated - Isolate - Aislante - Isolant  
Monopolar - Monopolari

new

mit sterilisierfähiger Kunststoff-Isolierbeschichtung - with autoclavable plastic coated insulated handles  
con rivestimento isolante in plastica sterilizzabile - con recubrimiento aislante de materia plástica esterilizable  
à enduit plastique isolant, stérilisable

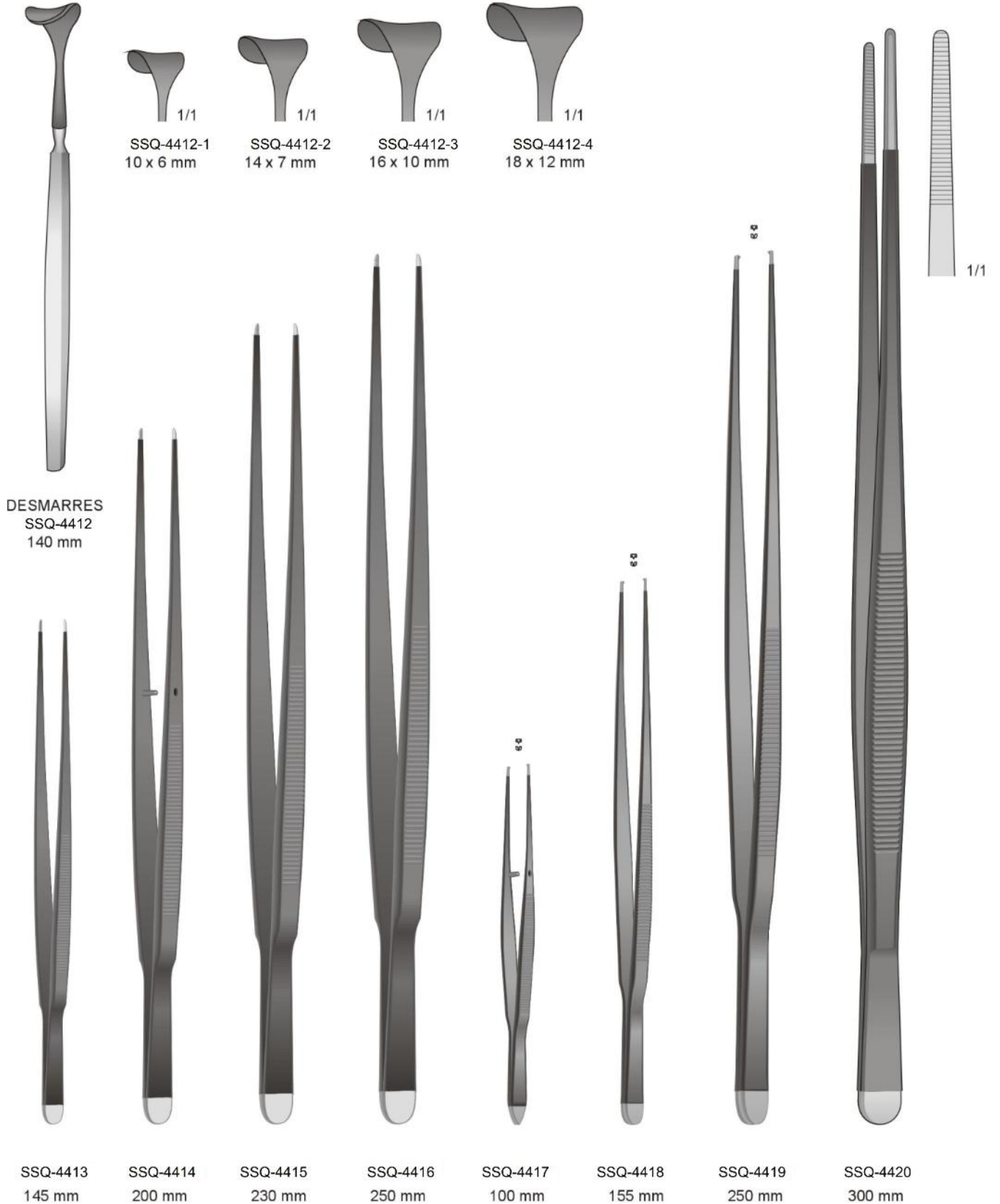

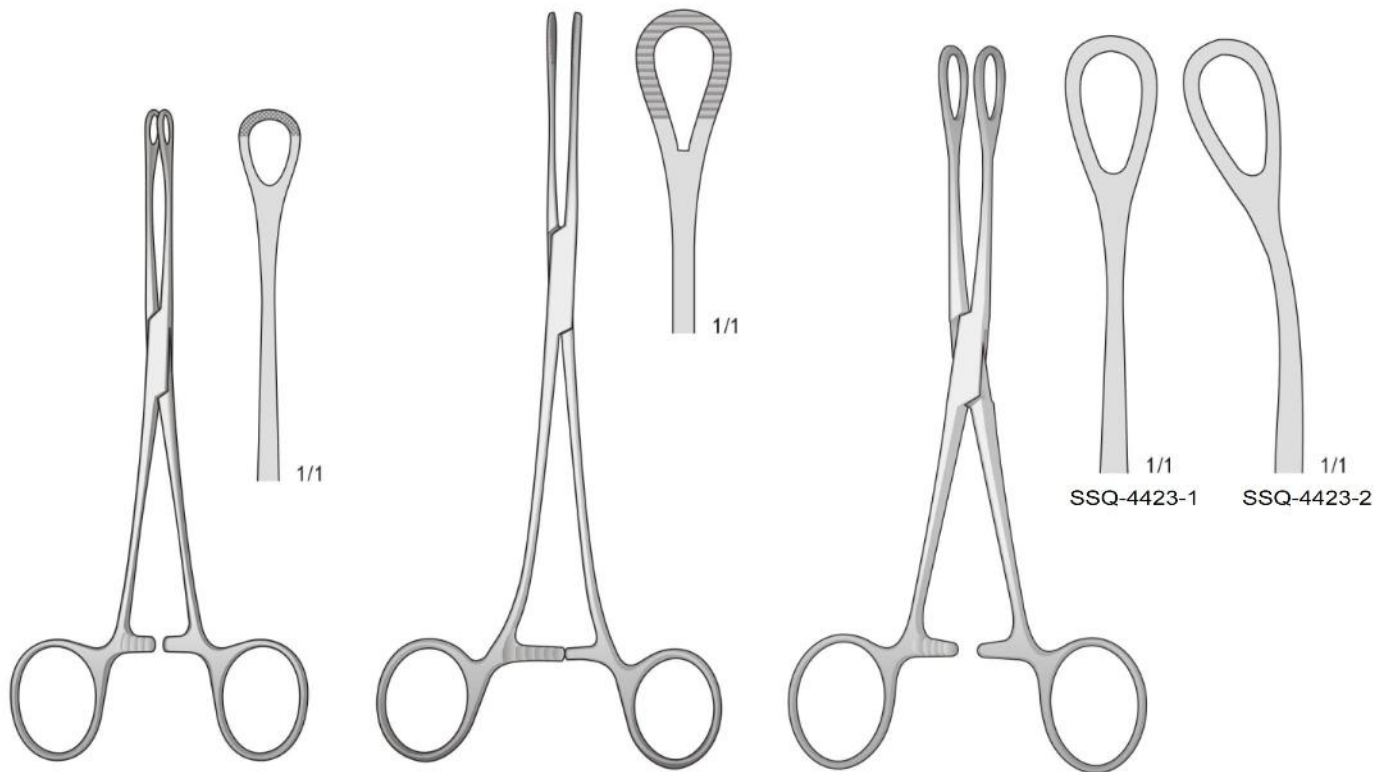

WILLIAMS  
SSQ-4421  
165 mm

SSQ-4422  
200 mm

FOERSTER  
SSQ-4423  
180 mm

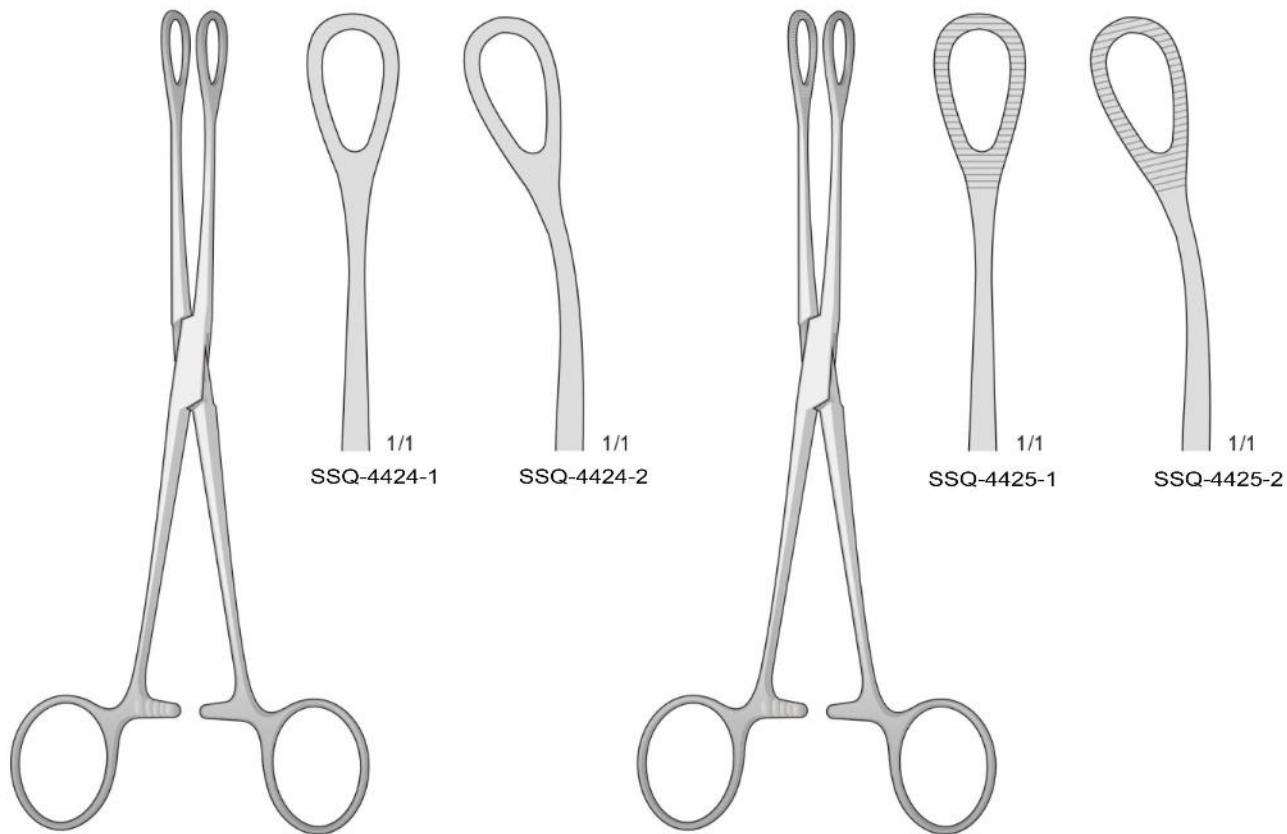

FOERSTER  
SSQ-4424  
200 mm

FOERSTER  
SSQ-4425  
200 mm

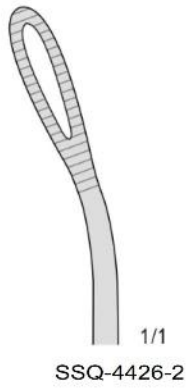
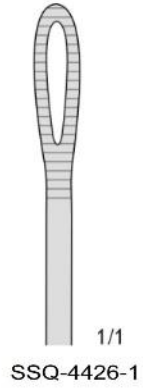
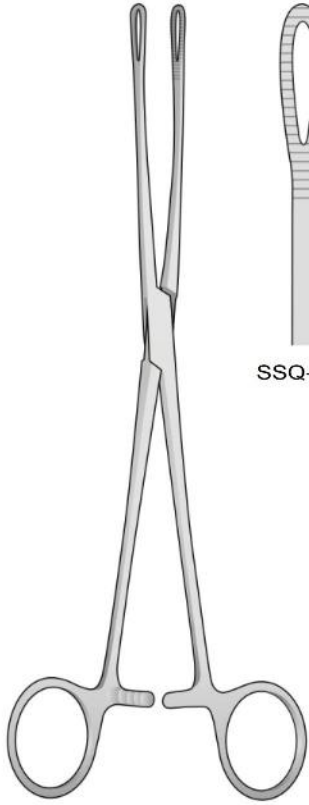

FOERSTER  
SSQ-4426  
250 mm

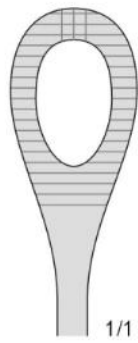
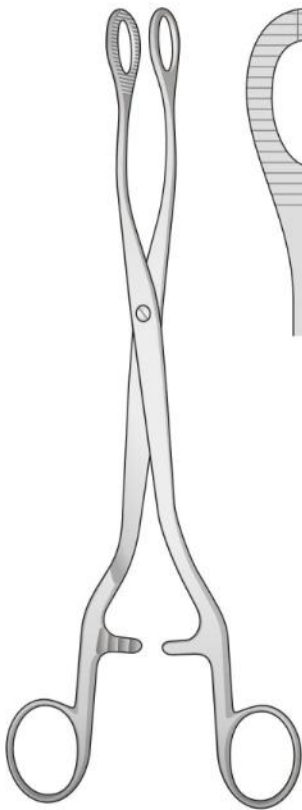

HEYWOOD-SMITH  
SSQ-4427  
250 mm

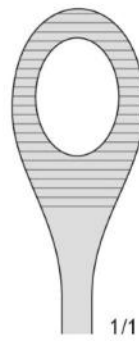
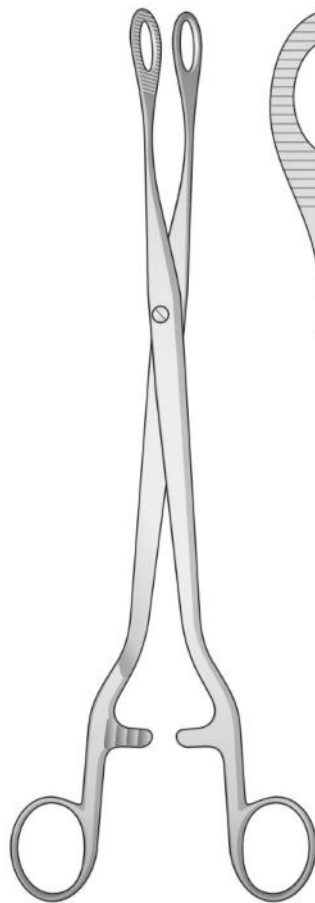

NOTO  
SSQ-4428  
280 mm

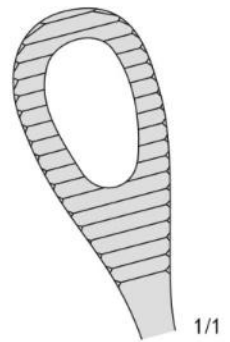
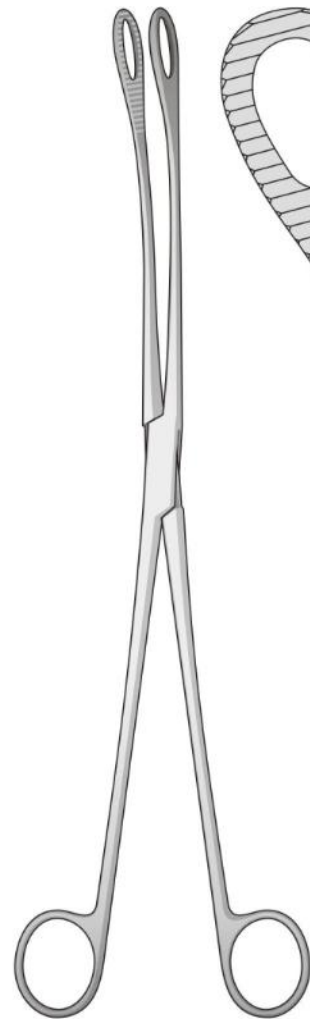

KELLY  
SSQ-4429  
320 mm

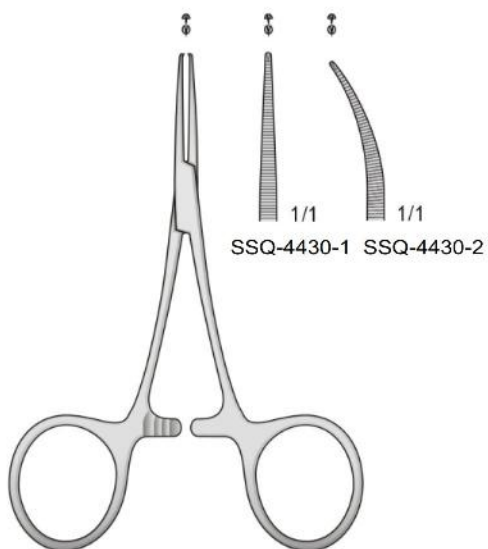

HARTMANN-BABY-MOSQUITO  
SSQ-4430  
95 mm

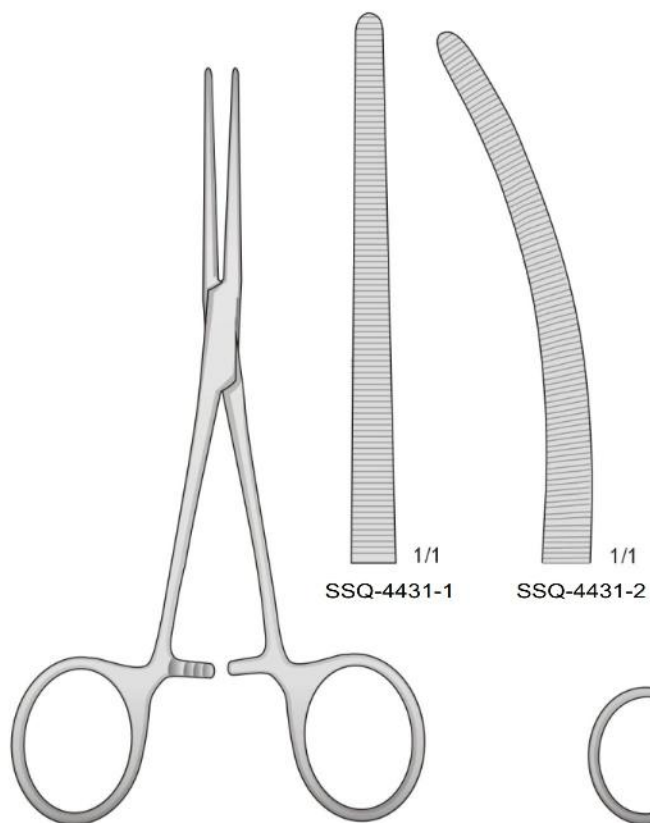

ROCHESTER-PEAN  
SSQ-4431  
225 mm

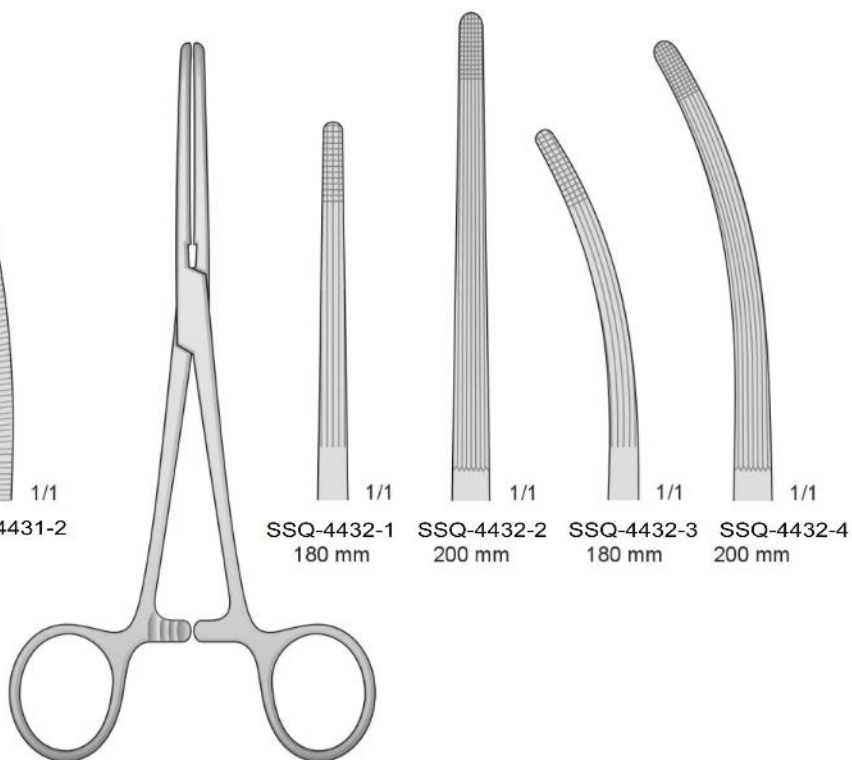

ROCHESTER-CARMALT  
SSQ-4432



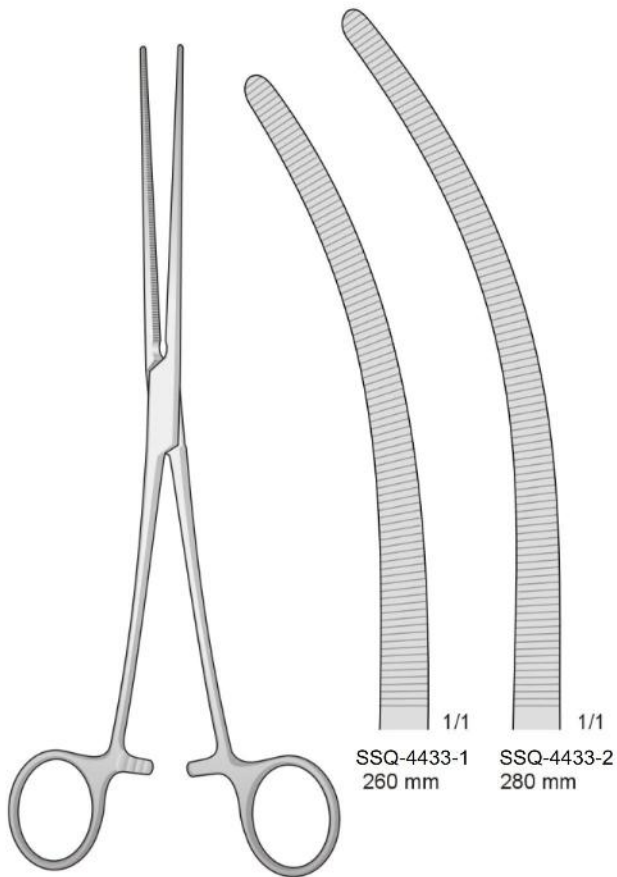
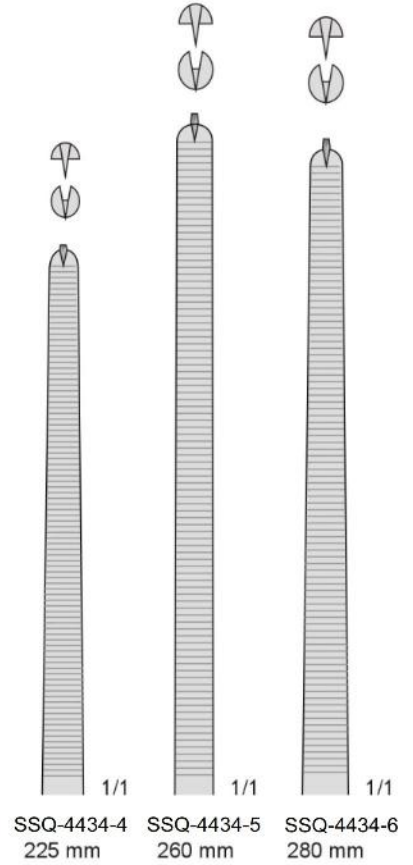
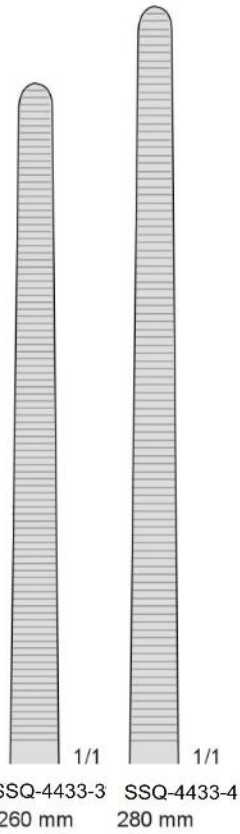

PEAN  
SSQ-4433

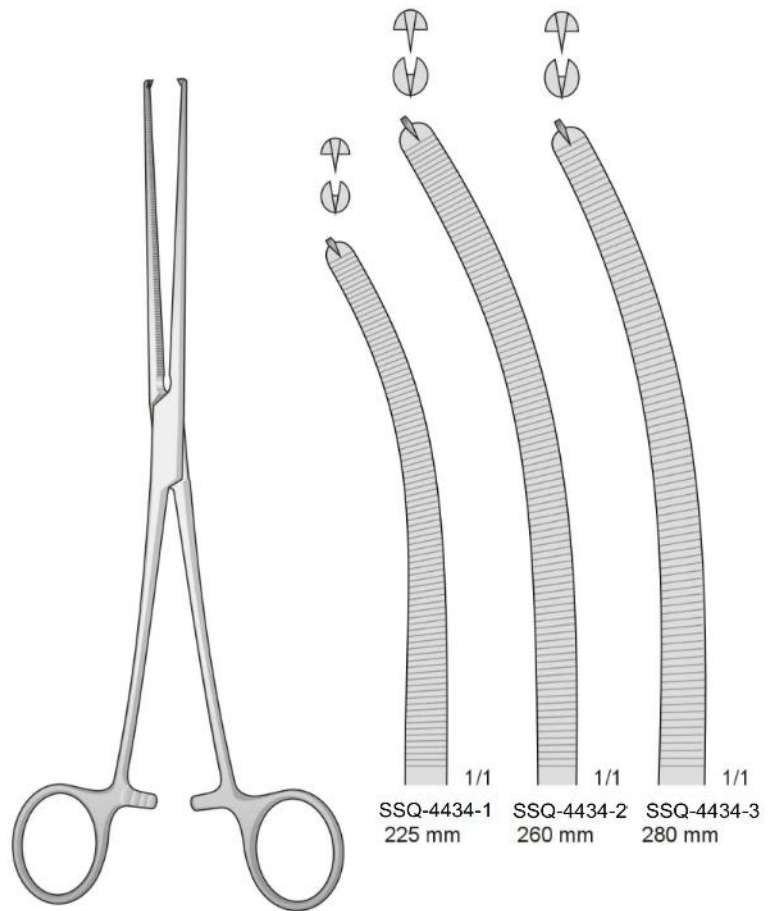

KOCHER-OCHSNER  
SSQ-4434

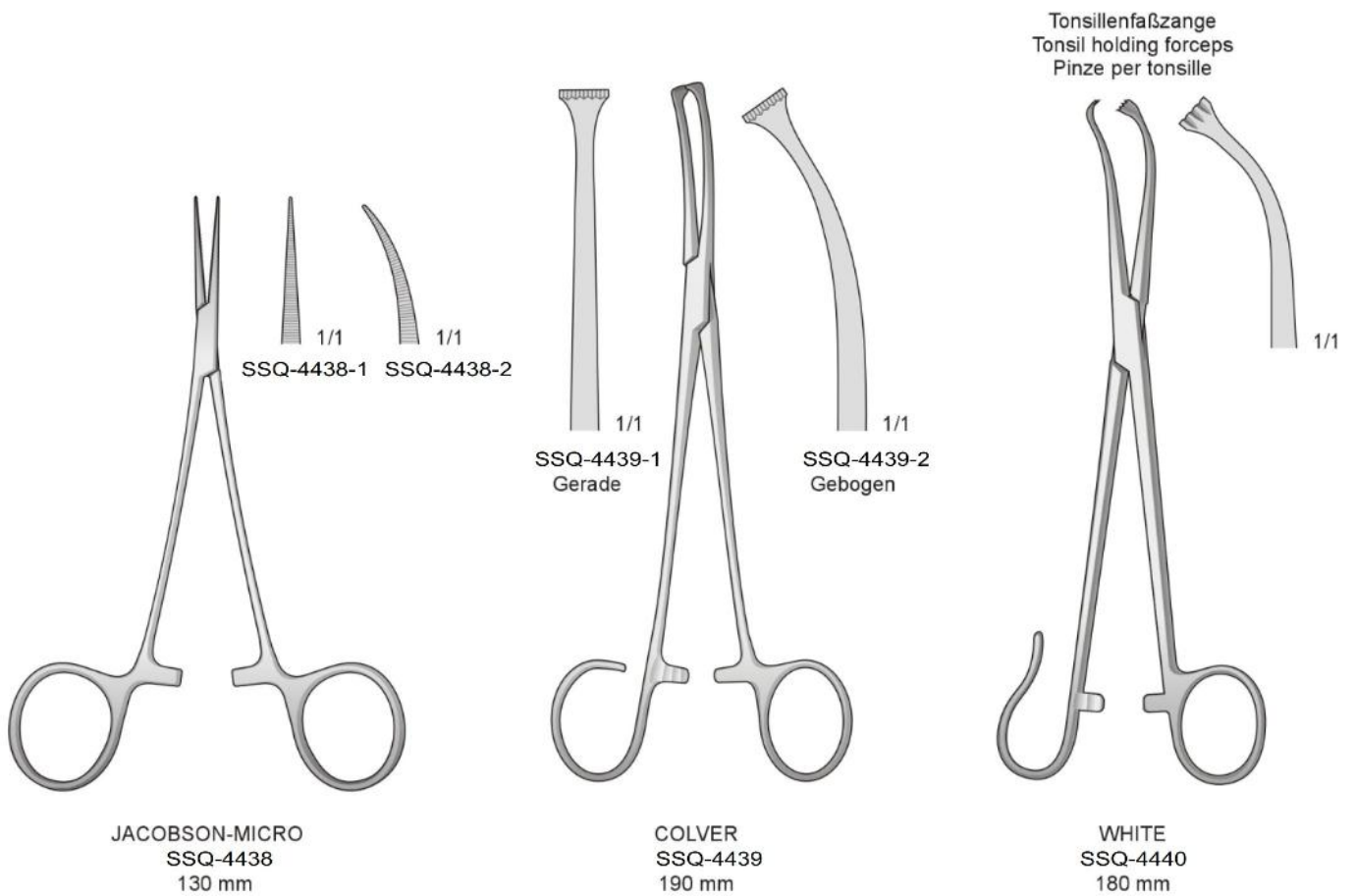
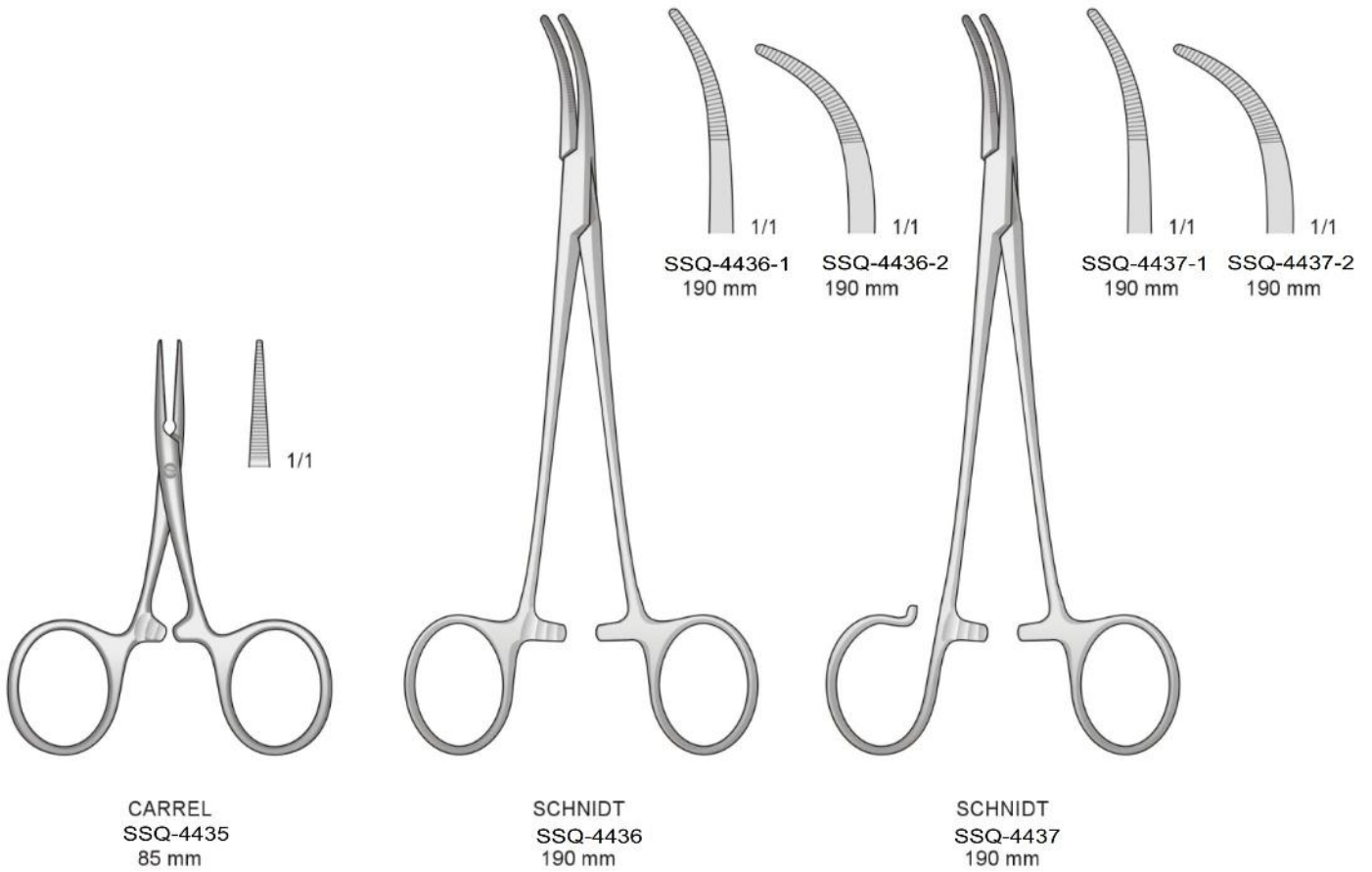

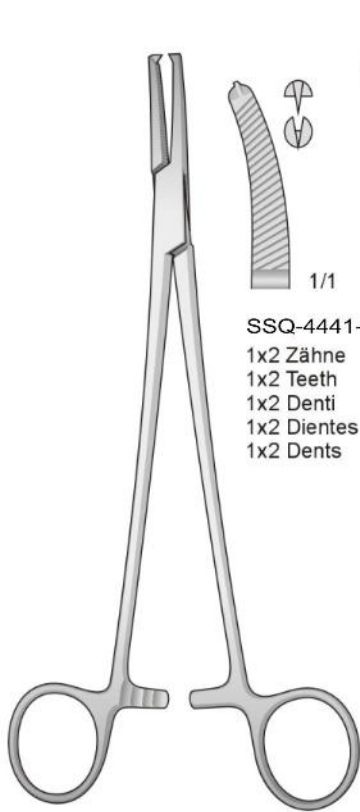

**FAURE**  
SSQ-4441  
200 mm

SSQ-4441-1	SSQ-4441-2
1x2 Zähne	1x2 Zähne
1x2 Teeth	1x2 Teeth
1x2 Denti	1x2 Denti
1x2 Dientes	1x2 Dientes
1x2 Dents	1x2 Dents

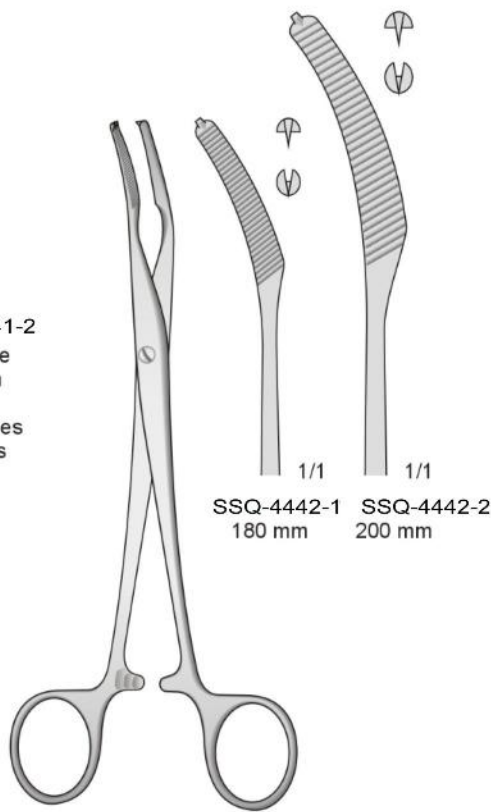

**MIKULICZ**  
SSQ-4442

SSQ-4442-1	SSQ-4442-2
180 mm	200 mm

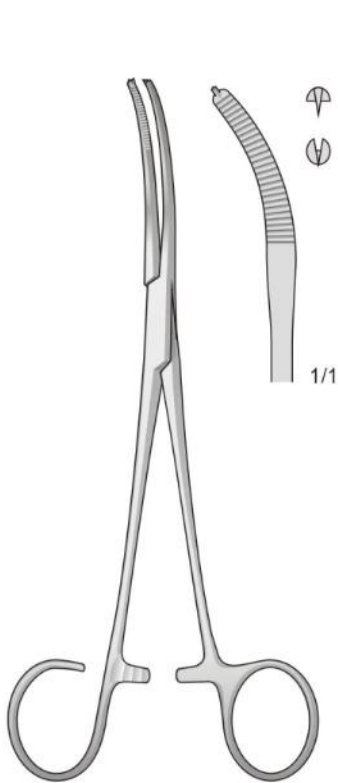

**MIKULICZ**  
SSQ-4443  
185 mm

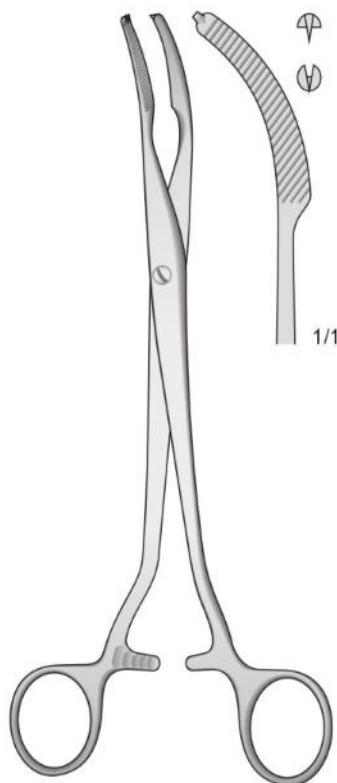

**MIKULICZ**  
SSQ-4444  
200 mm

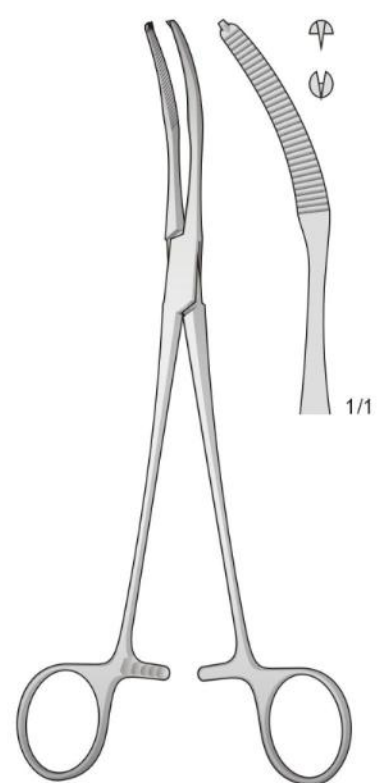

**MIKULICZ**  
SSQ-4445  
200 mm

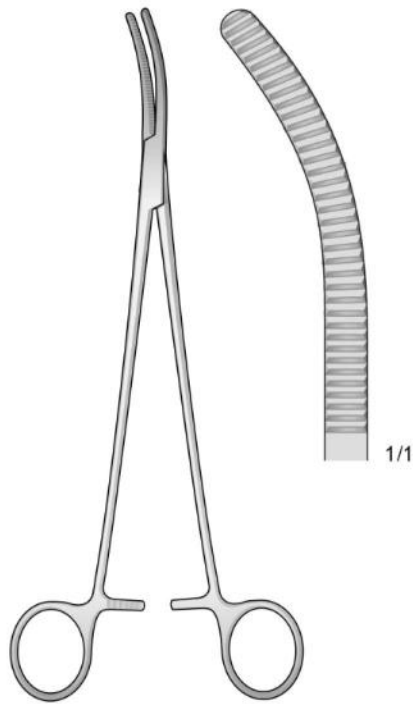

WERTHEIM  
SSQ-4446  
250 mm

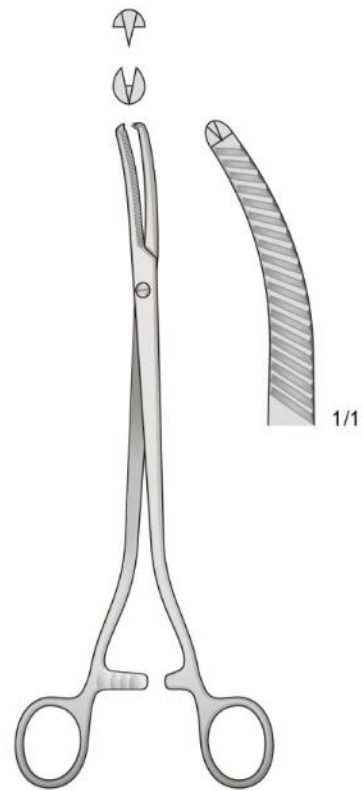

WERTHEIM  
SSQ-4447  
230 mm

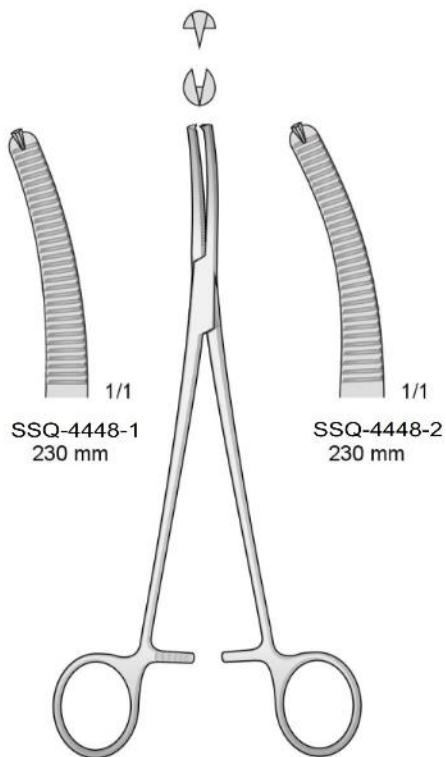

WERTHEIM  
SSQ-4448  
230 mm

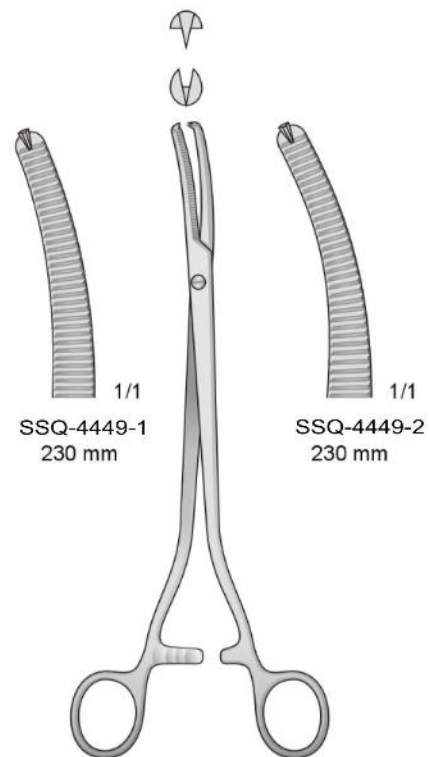

WERTHEIM  
SSQ-4449  
230 mm

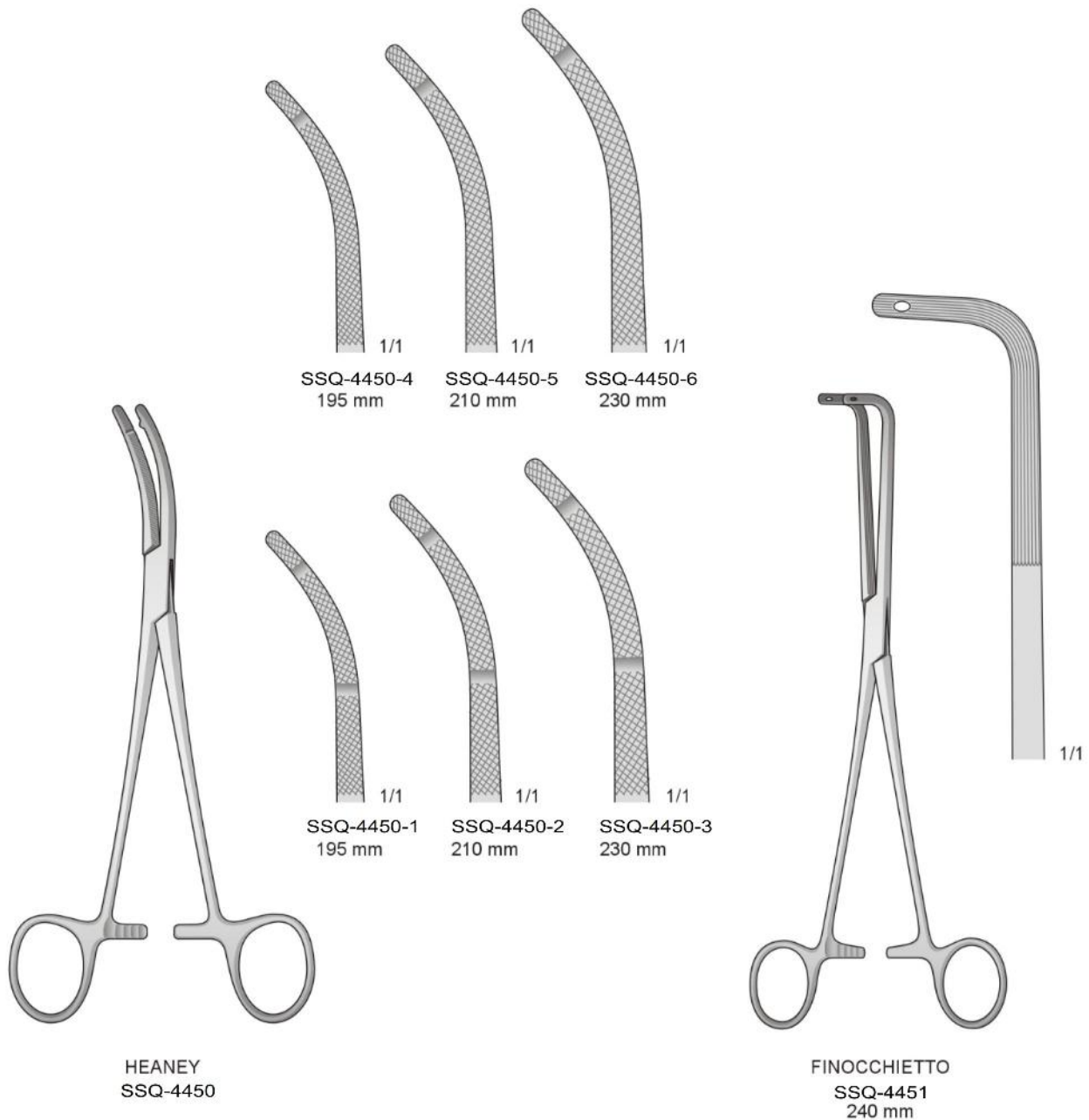

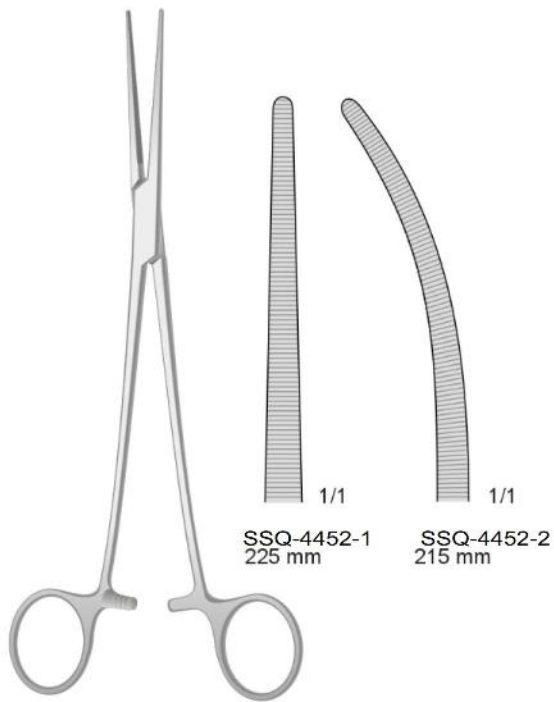

ROBERTS  
SSQ-4452

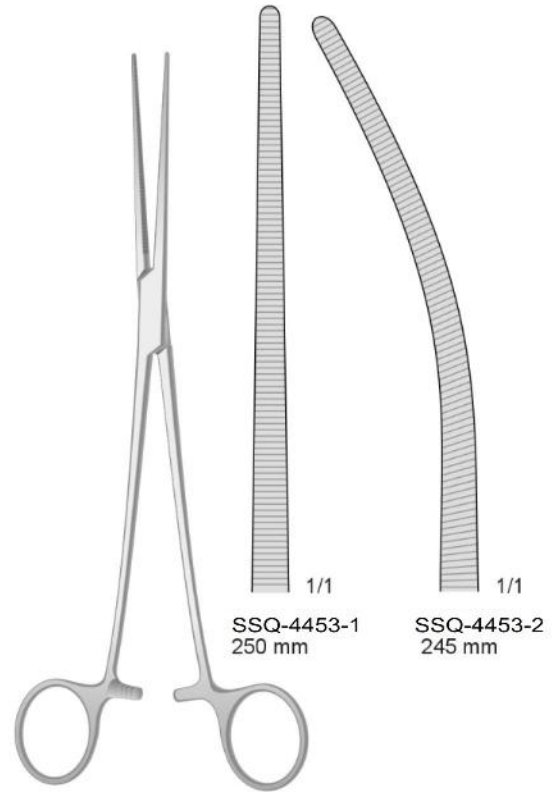

SAROT  
SSQ-4453

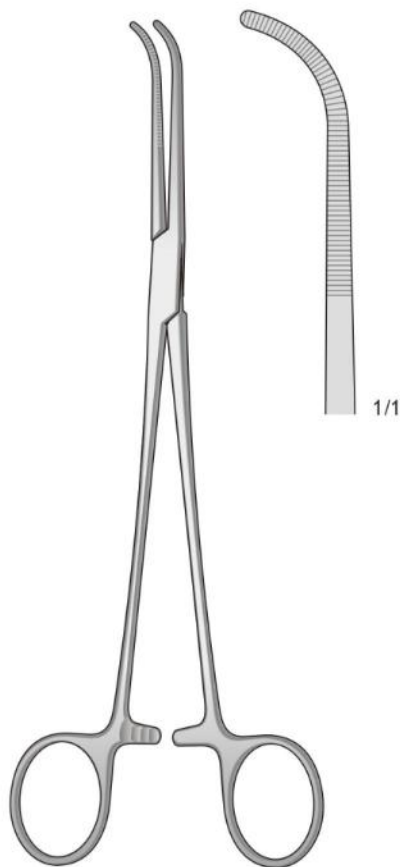

MIXTER  
SSQ-4454  
225 mm

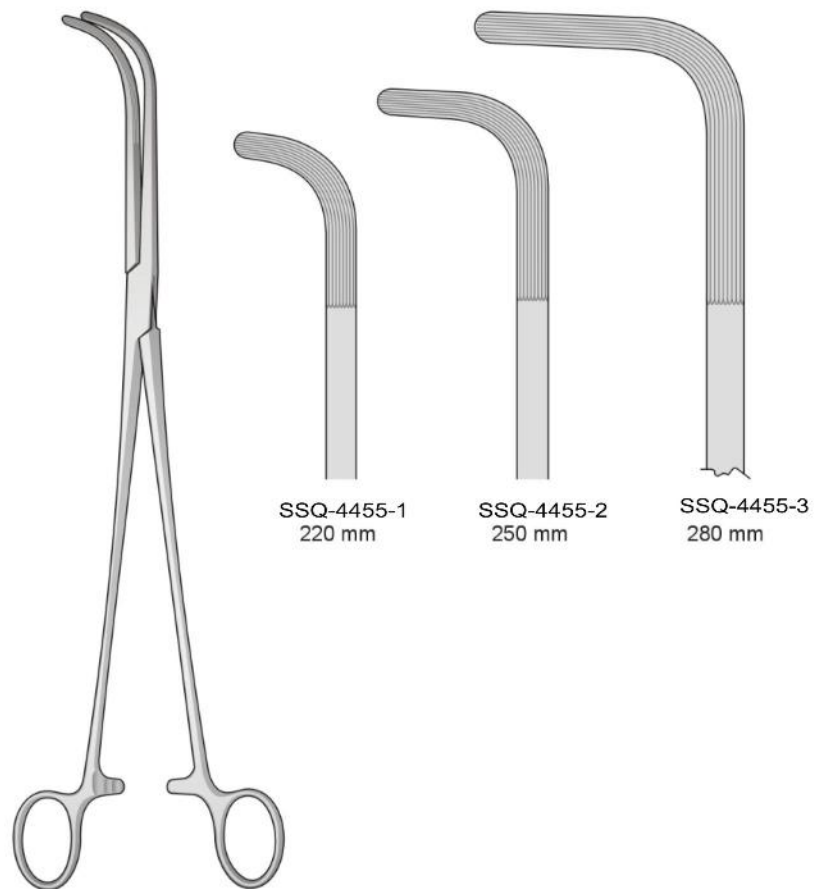

MIXTER  
SSQ-4455

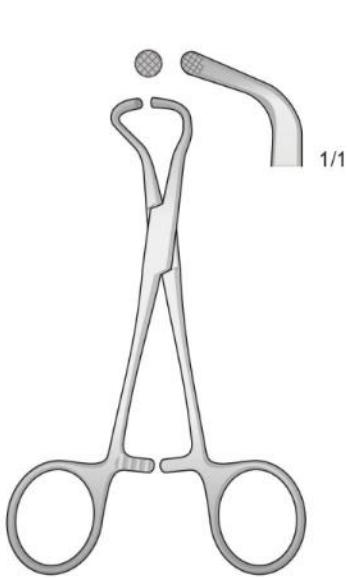

SSQ-4456  
100 mm

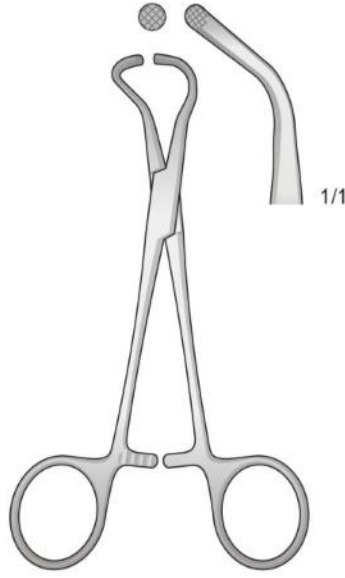

SSQ-4457  
125 mm

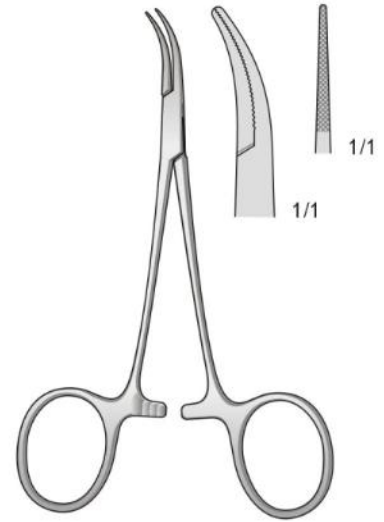

DANDY-MOSQUITO  
SSQ-4458  
120 mm

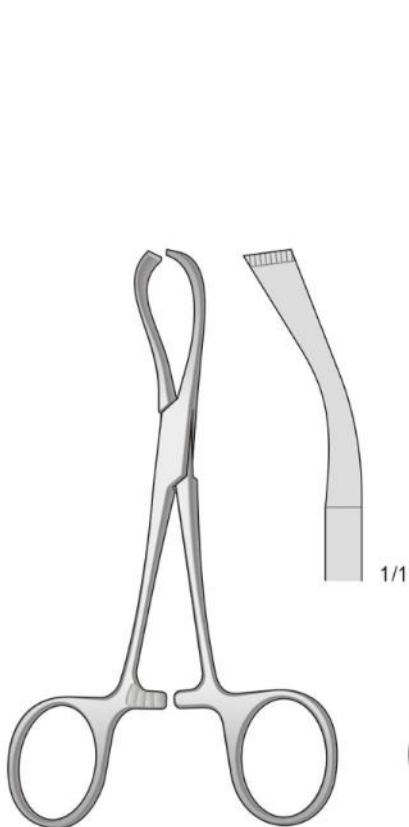

LORNA  
SSQ-4459  
130 mm



LANE  
SSQ-4460

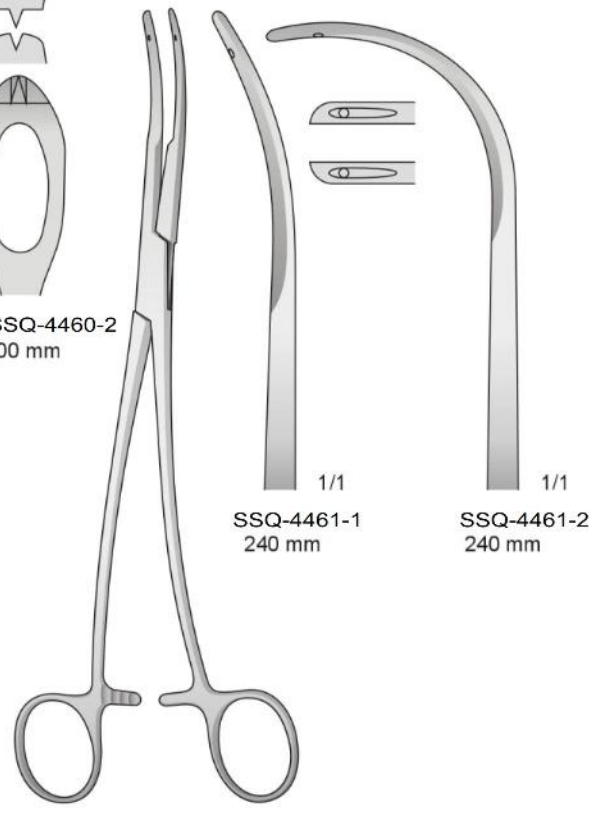

SEMB  
SSQ-4461  
240 mm

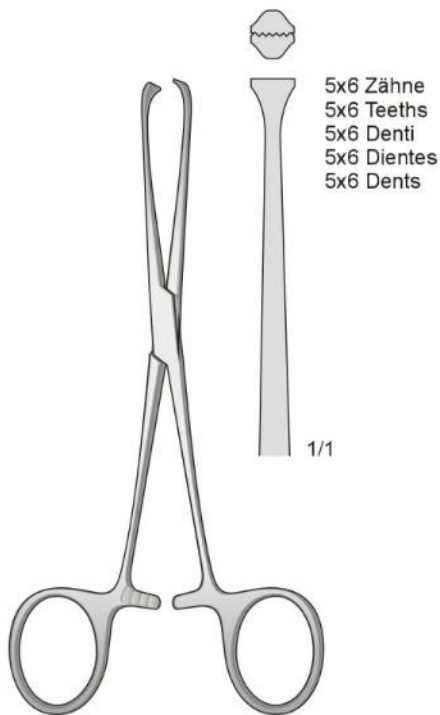

5x6 Zähne  
5x6 Teeths  
5x6 Denti  
5x6 Dientes  
5x6 Dents

1/1

**BOYS-ALLIS**  
SSQ-4462  
150 mm

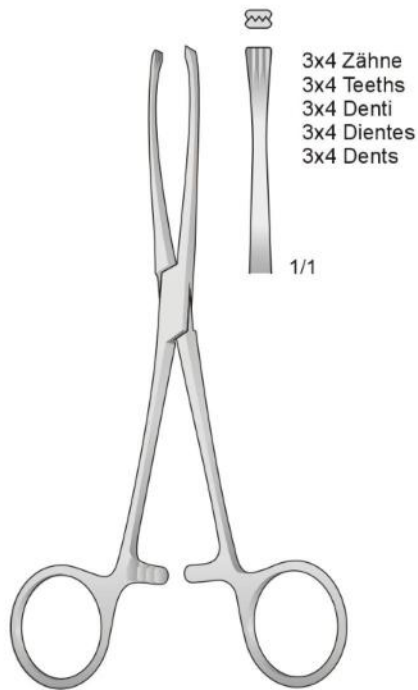

3x4 Zähne  
3x4 Teeths  
3x4 Denti  
3x4 Dientes  
3x4 Dents

1/1

**JUDD-ALLIS**  
SSQ-4463  
155 mm

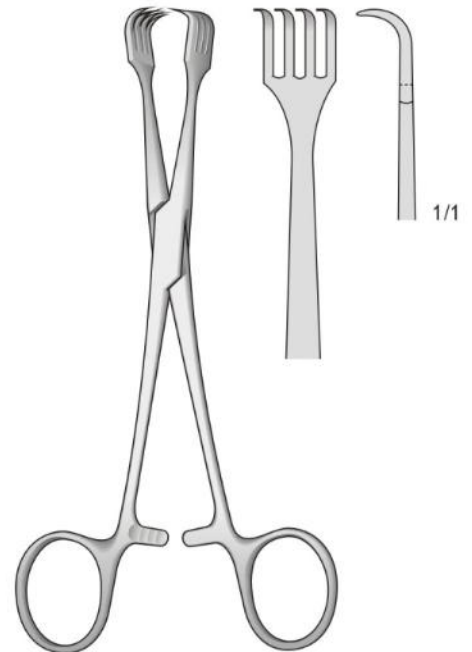

1/1

**BRAUN**  
SSQ-4464  
155 mm

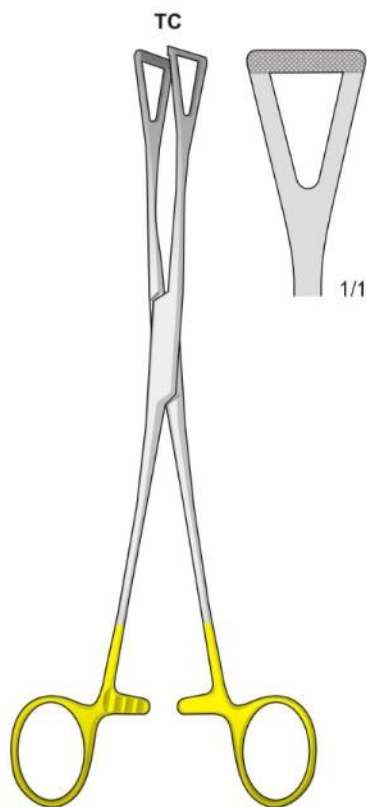

TC

1/1

**DUVAL**  
SSQ-4465  
200 mm

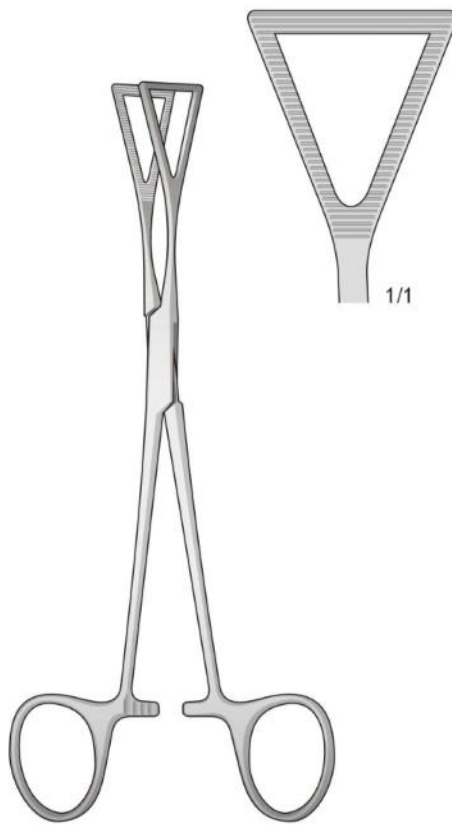

1/1

**LOVELACE**  
SSQ-4466  
200 mm

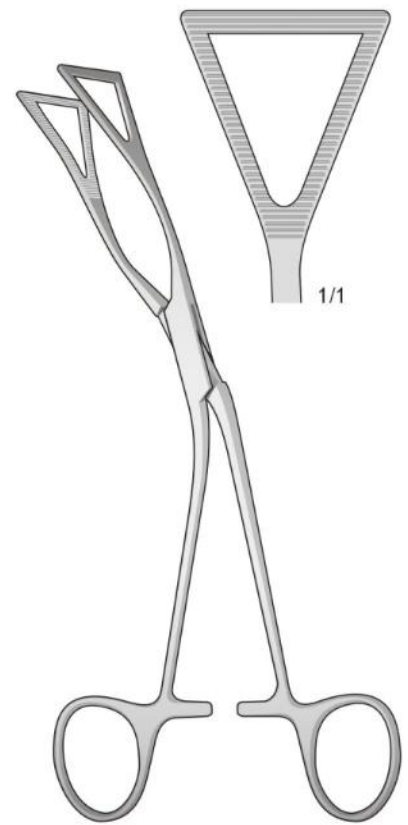

1/1

**LOVELACE**  
SSQ-4467  
200 mm





PEET  
SSQ-4468  
120 mm

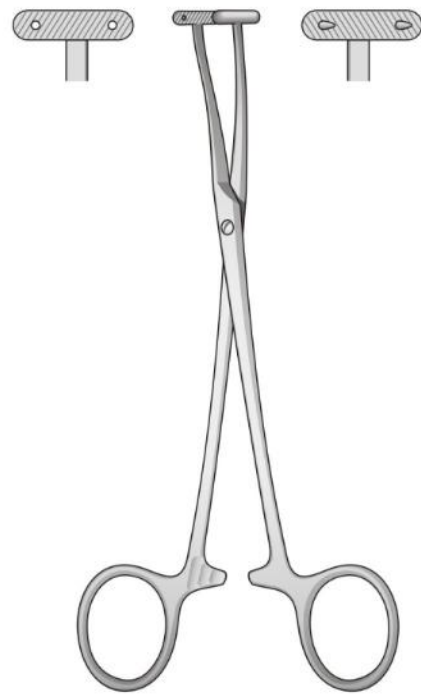

DE MARTEL  
SSQ-4469  
180 mm



MIXTER  
SSQ-4470  
220 mm

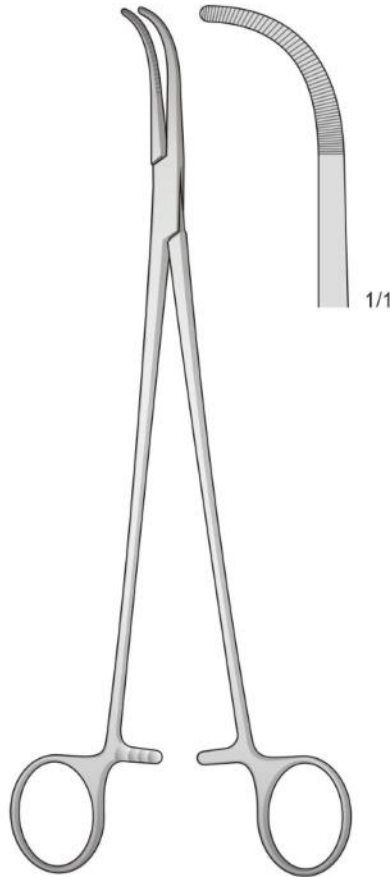

MIXTER  
SSQ-4471  
230 mm

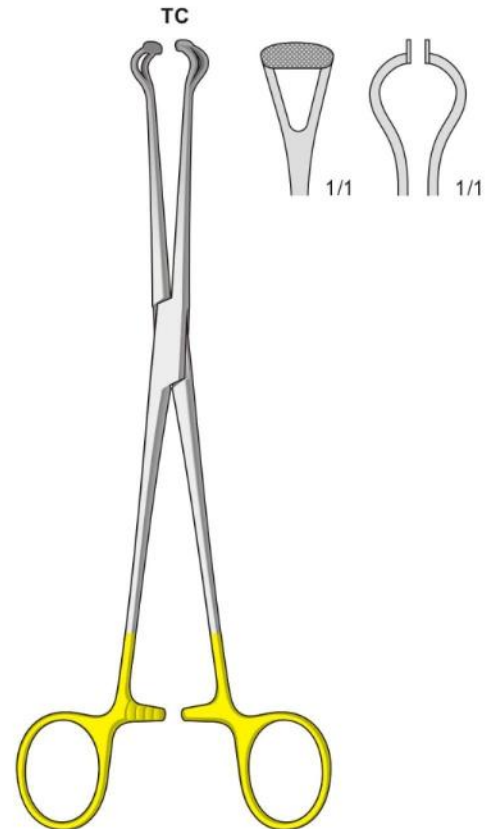

BABCOCK  
SSQ-4472  
210 mm

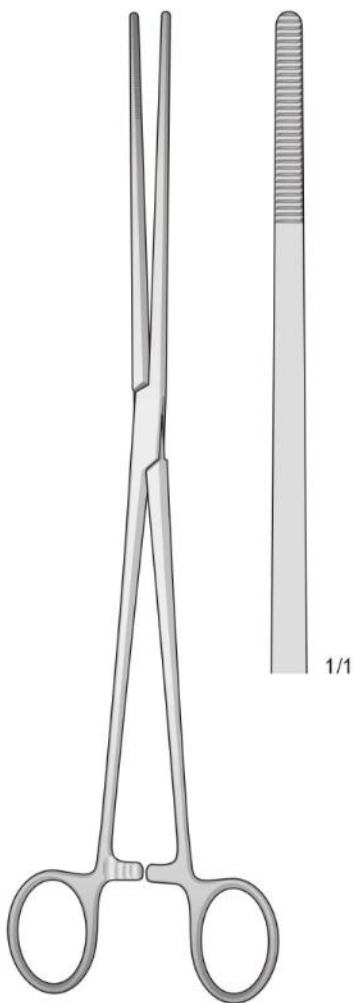

BOZEMANN  
SSQ-4473  
260 mm

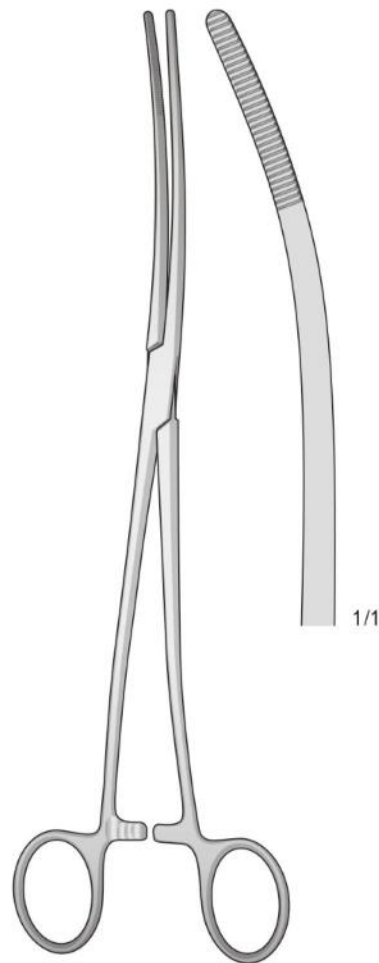

BOZEMANN  
SSQ-4474  
260 mm

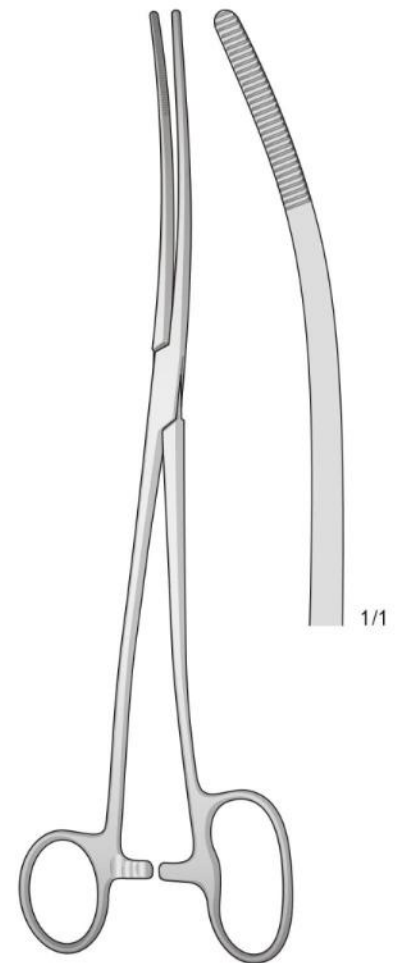

BOZEMANN-DOUGLAS  
SSQ-4475  
260 mm



Atraumatiche



Atraumatiche



SSQ-4477-1  
250 mm

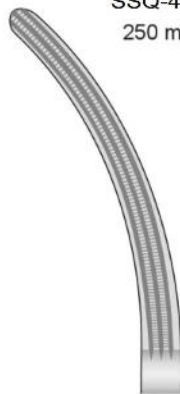

18-1900-02  
SSQ-4477-2



SSQ-4477-3  
240 mm

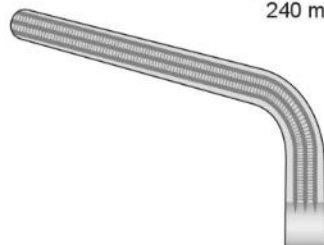

SSQ-4477-4  
230 mm

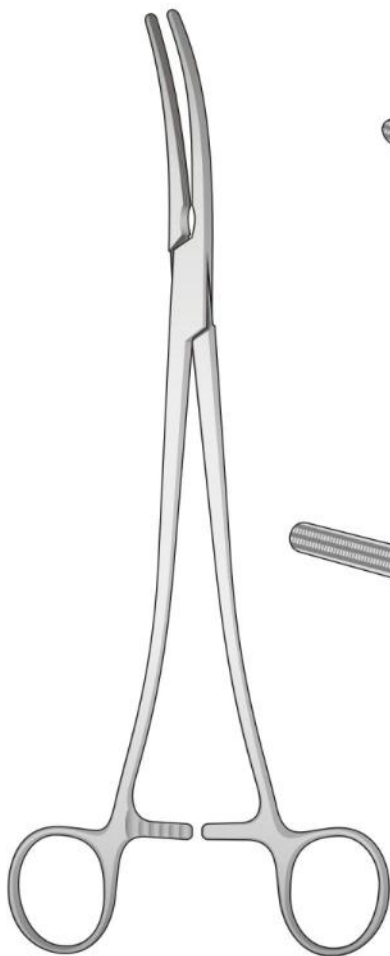

SSQ-4477  
WERTHEIM

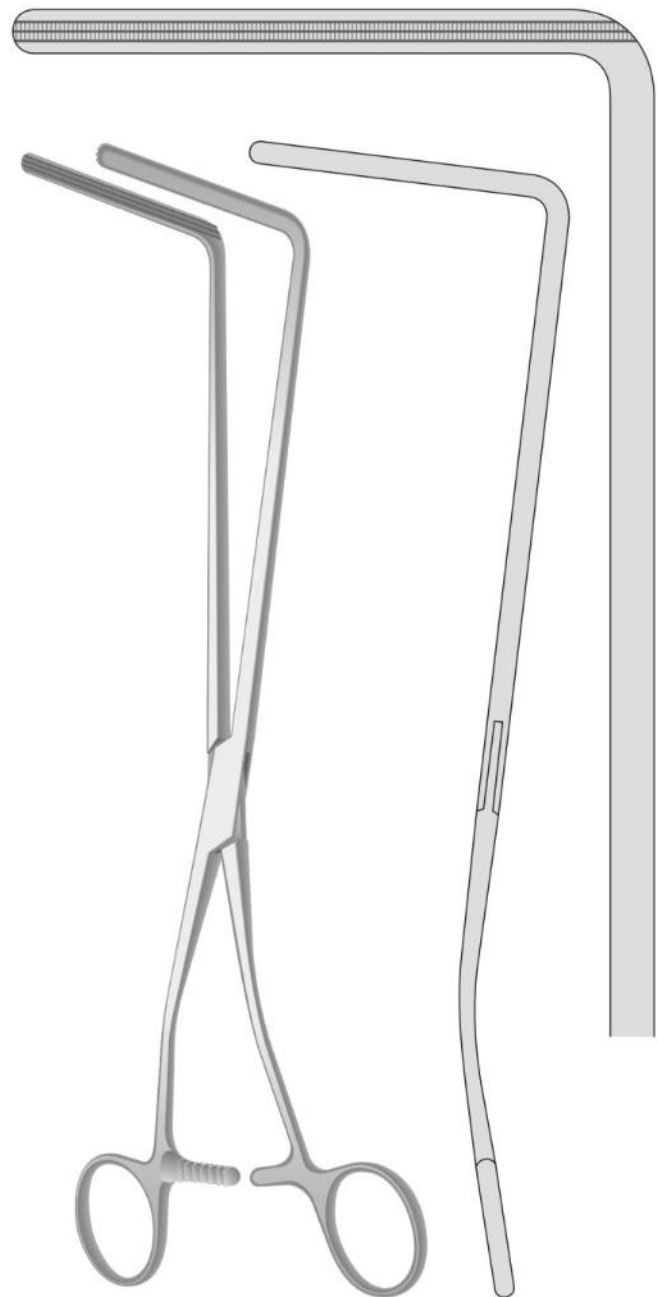

RESANO  
SSQ-4476  
280 mm

1/1

Weich und elastisch  
With soft and  
elastic blades

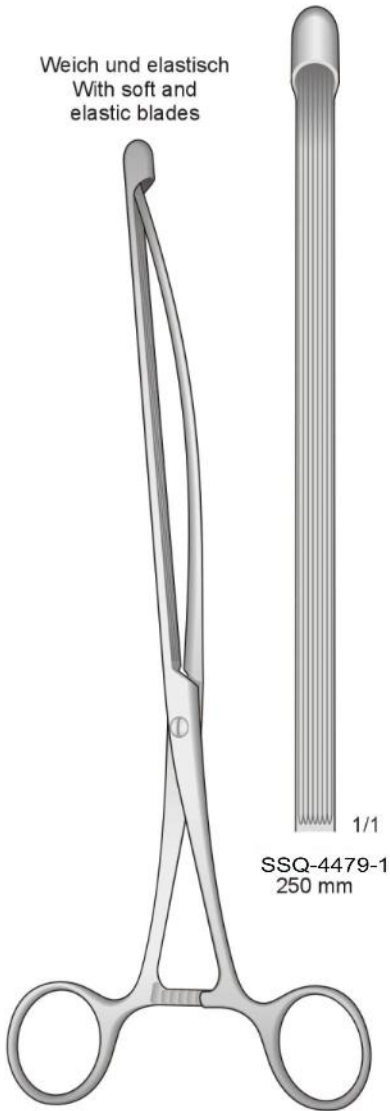

NUSSBAUM  
SSQ-4479  
250 mm

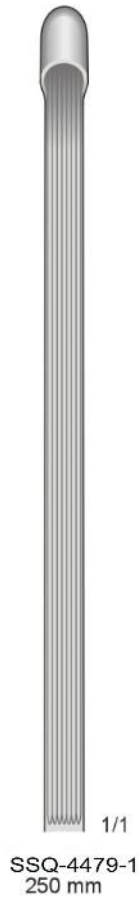

SSQ-4479-1  
250 mm

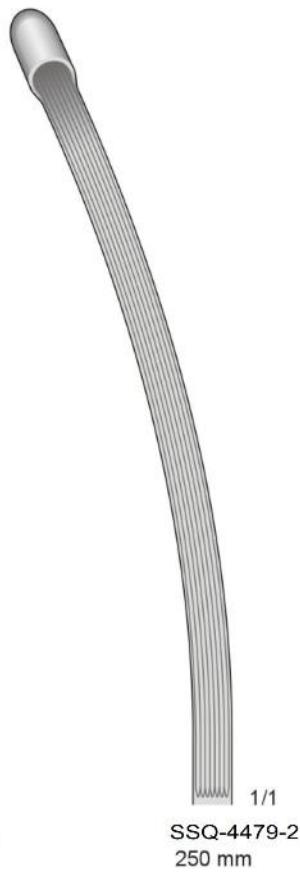

SSQ-4479-2  
250 mm

Atrauma

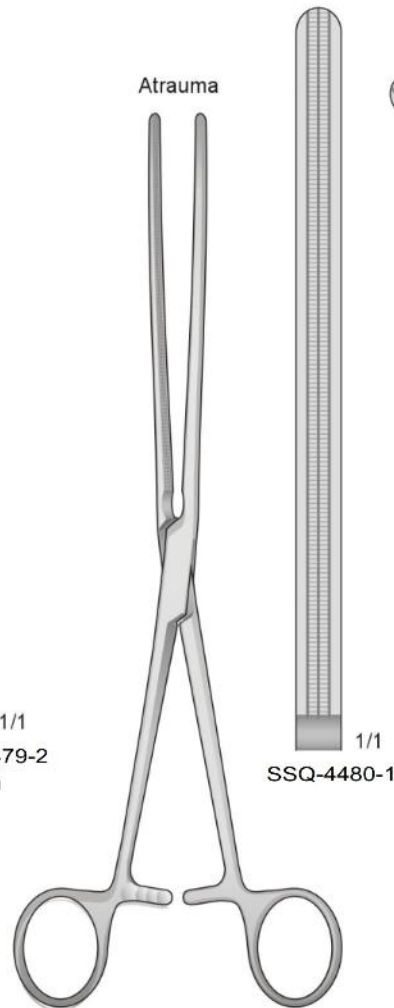

DOYEN  
SSQ-4480  
230 mm

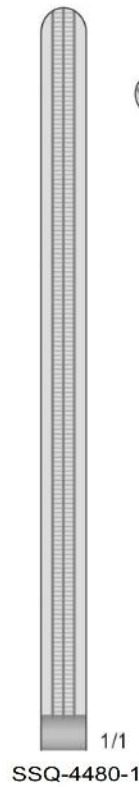

SSQ-4480-1

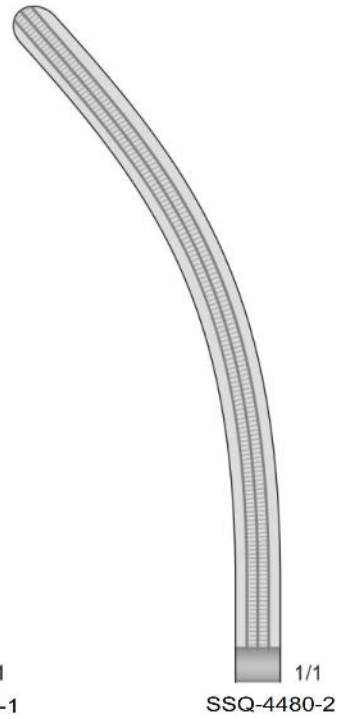

SSQ-4480-2

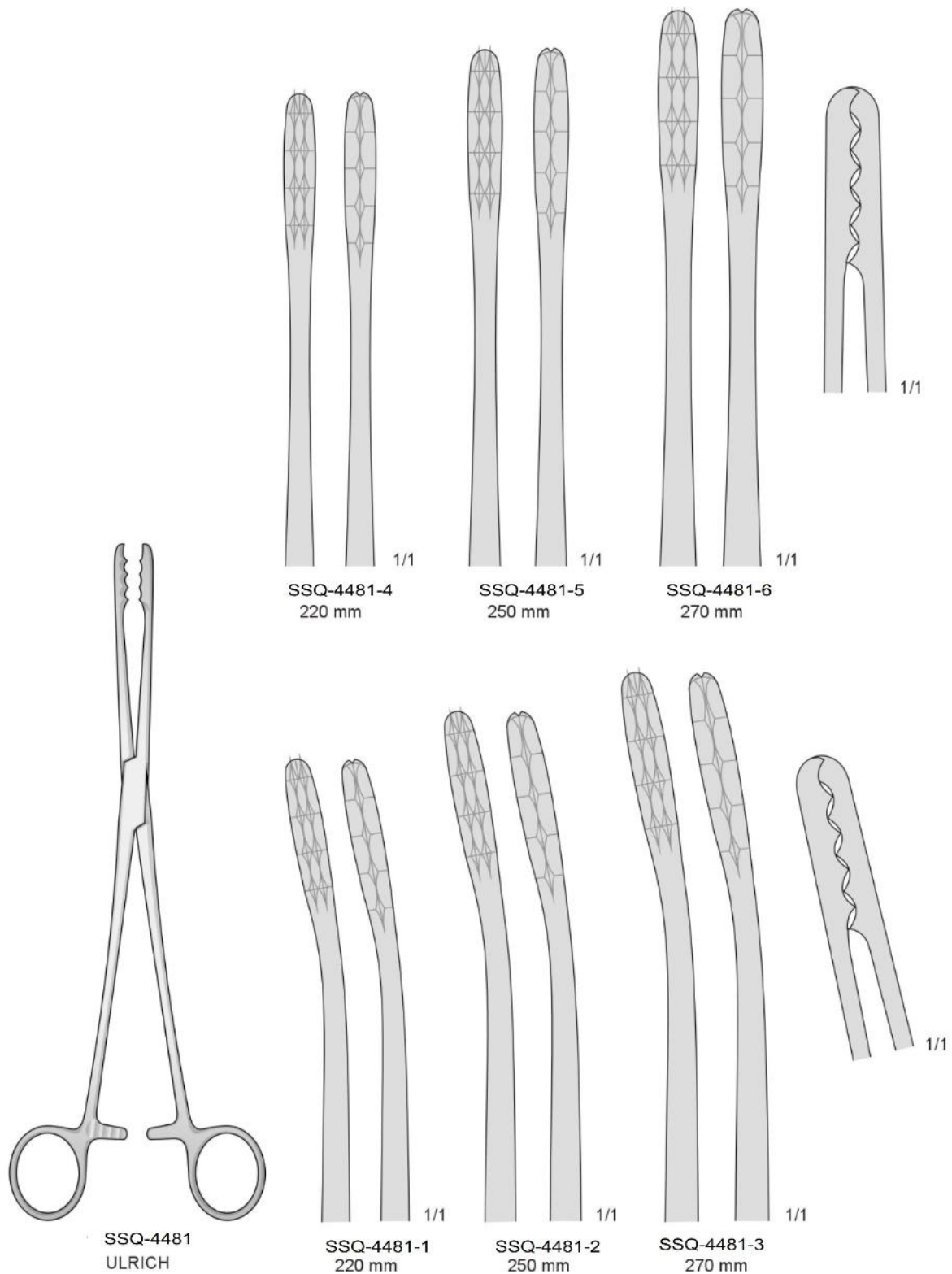

Titan - Titanium - Titanio - Titane

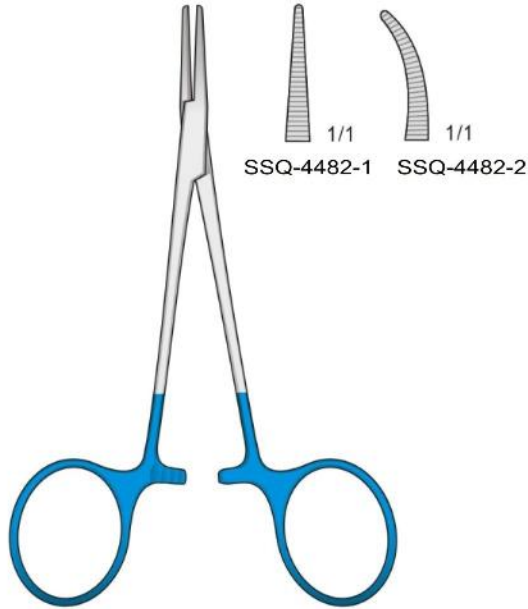

HALSTED-MOSQUITO  
SSQ-4482  
120 mm

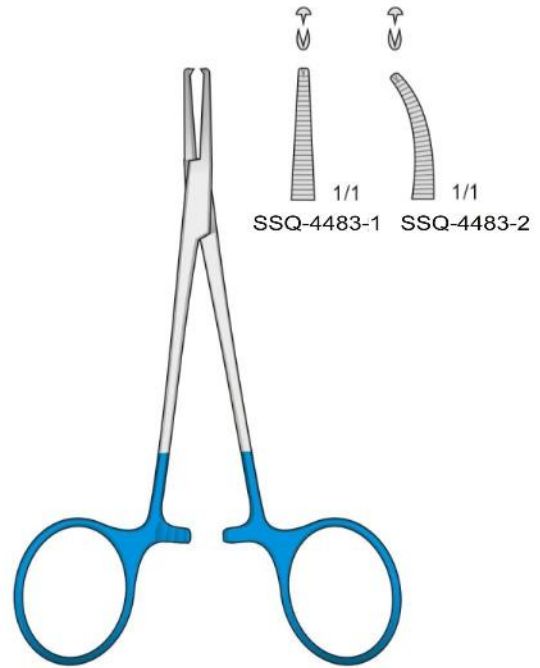

HALSTED-MOSQUITO  
SSQ-4483  
120 mm

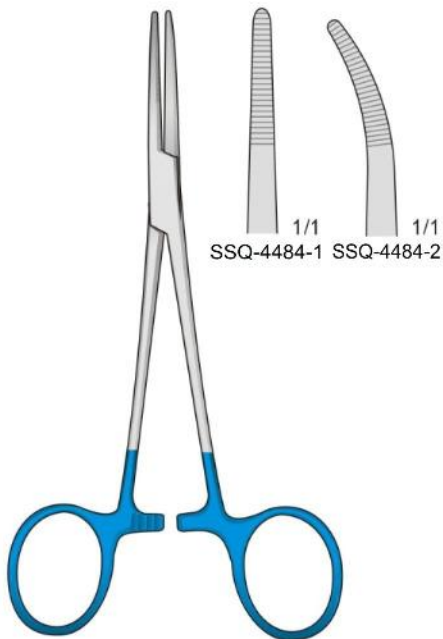

KELLY  
SSQ-4484  
140 mm

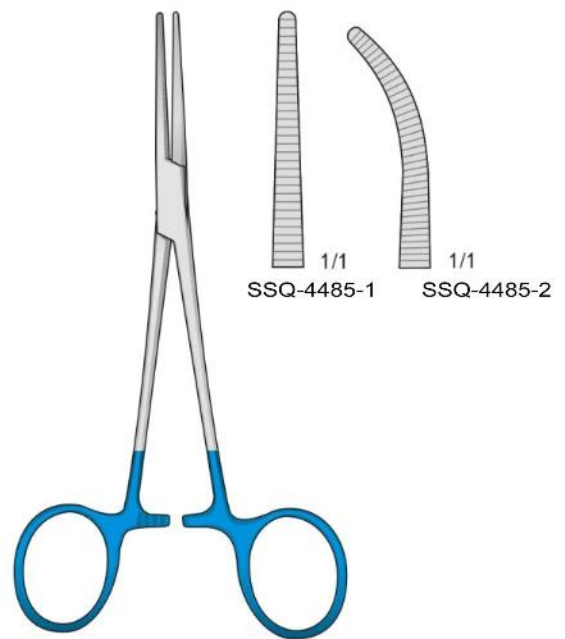

CRILE  
SSQ-4485  
140 mm

18-2060  
Krampfaderbesteck komplett  
Varicose Vein Probe Set complete  
Set completo sonda per varici  
Juego para varices completo  
Trousse à varices complète

Metall-Sondenspitzen  
Probe tip, metal  
Punta per sonda  
in metallo  
Punta metálica  
Pointe en métal

Ø 3 mm

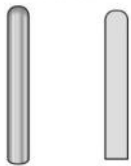

SSQ-4486



SSQ-4487

Oliven - Olives - Olive - Oliva - Olive



Ø 6 mm

SSQ-4487-1



Ø 9 mm

SSQ-4487-2

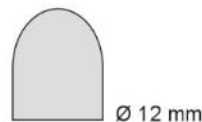

Ø 12 mm

SSQ-4487-3

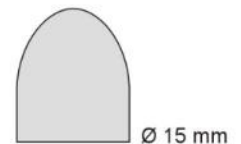

Ø 15 mm

SSQ-4487-4

Griff Allein  
Handle only  
Manico solo  
Mango solo  
Manche seule



SSQ-4488

Zugseil  
Traction Cable  
Cavo per trazione  
Cable de tracción  
Cable tracteur

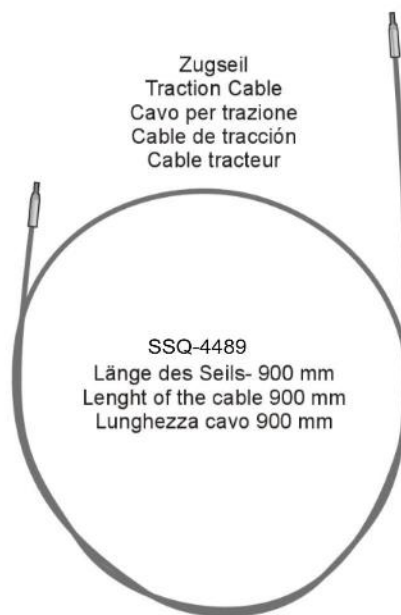

SSQ-4489  
Länge des Seils- 900 mm  
Length of the cable 900 mm  
Lunghezza cavo 900 mm

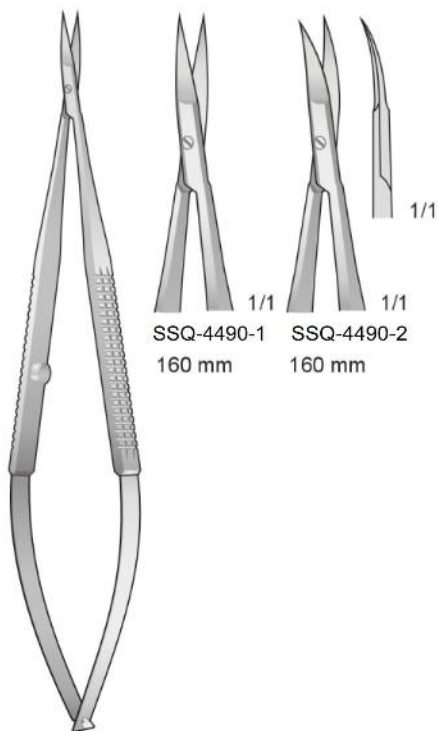

SSQ-4490  
160 mm

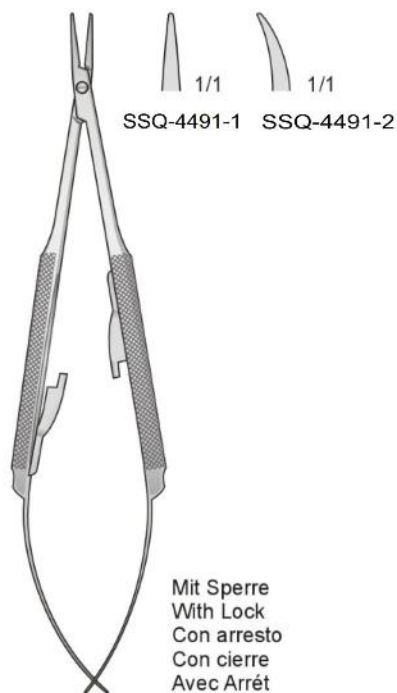

Mit Sperre  
With Lock  
Con arresto  
Con cierre  
Avec Arrêt

BARRAQUER  
SSQ-4491  
150 mm



CASTROVIEJO  
SSQ-4492  
140 mm

Nadelhalter mit Hartmetalleinlagen - Needle Holders with tungsten-carbide inserts  
Portaghi con inserti al tungsteno - Portaagujas con plaquetas de carburo de tungsteno  
Porte aiguilles avec plaquettes en carbure de tungstène

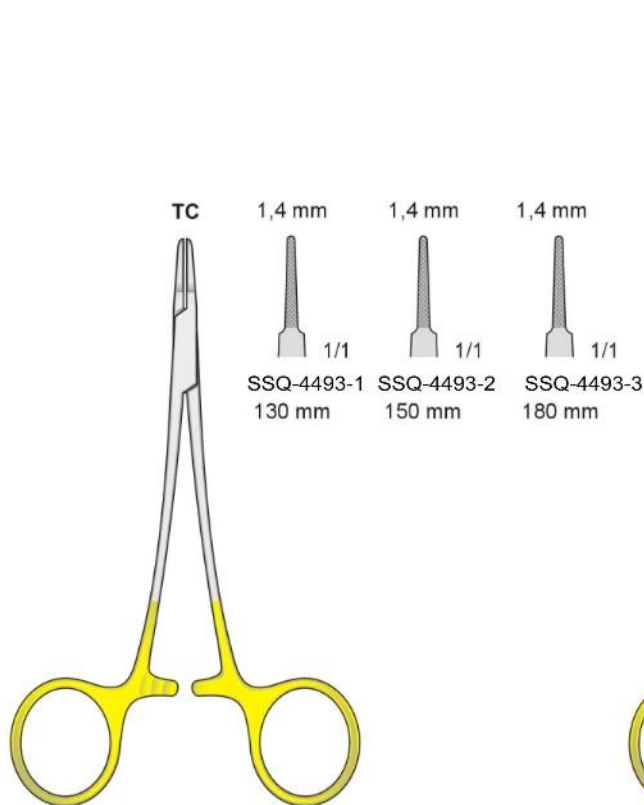

MICRO-RYDER  
SSQ-4493

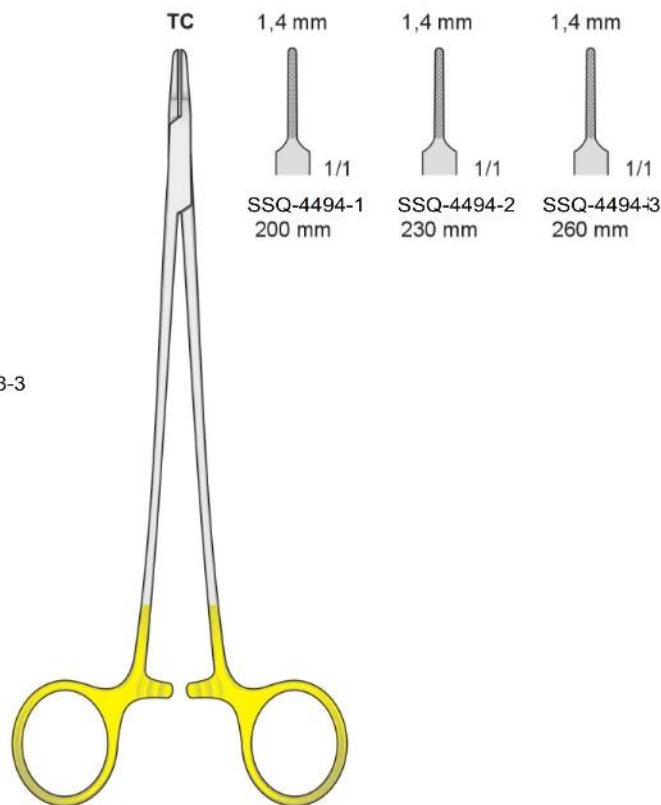

MICRO-RYDER  
SSQ-4494



Nadelhalter mit Hartmetalleinlagen - Needle Holders with tungsten-carbide inserts - Portaghi con inserti al tungsteno  
Portaagujas con plaquitas de carburo de tungsteno - Porte aiguilles avec plaquettes en carbure de tungstène

Ein Ring abgewinkelt  
One ring angled  
Un anello angolato

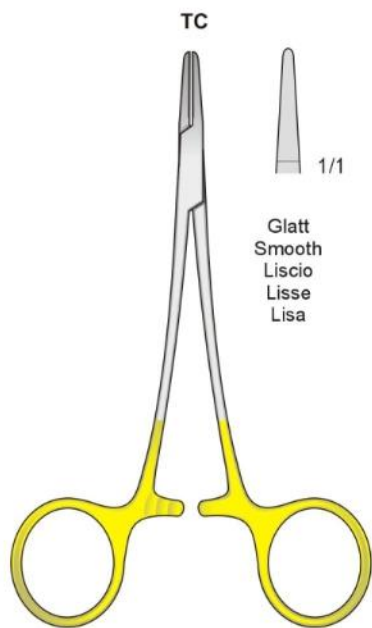

**HALSEY**  
SSQ-4495  
130 mm

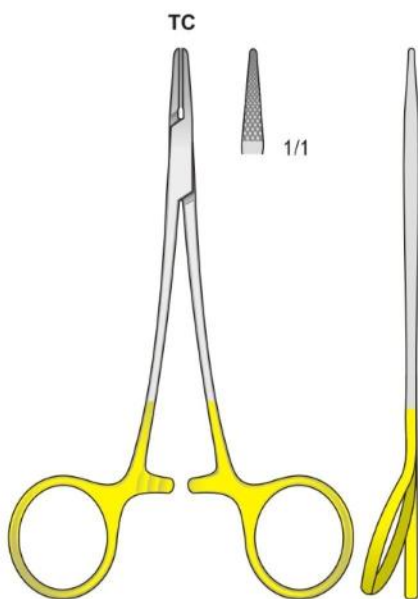

**SSQ-4496**  
120 mm

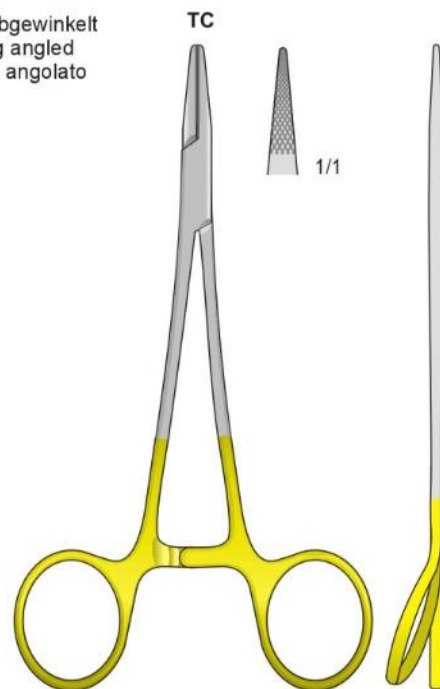

**CRILE-WOOD**  
SSQ-4497  
150 mm

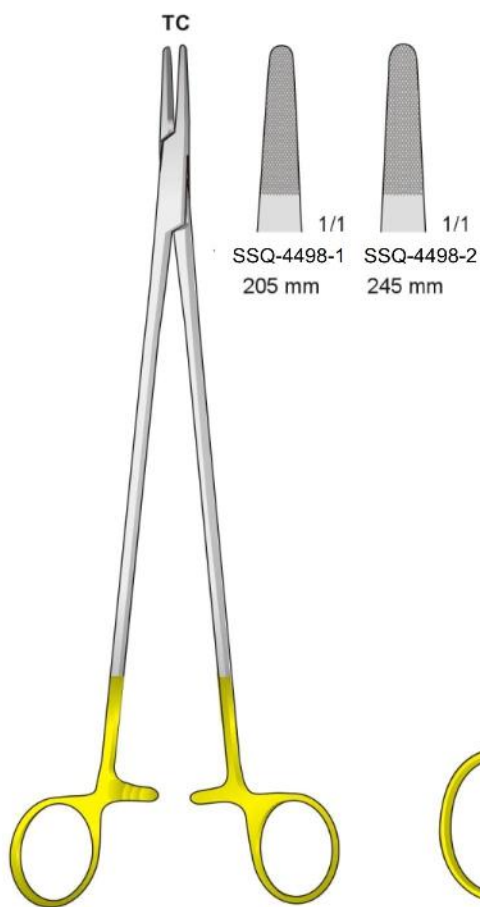

**HEGAR**  
SSQ-4498

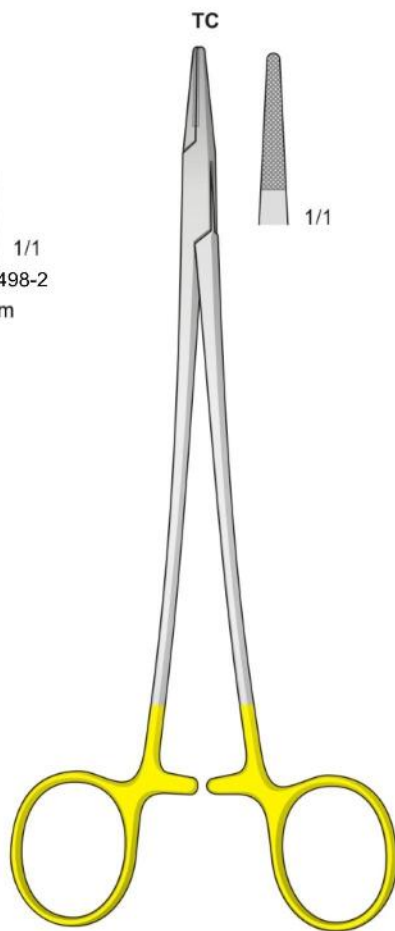

**DE BAKEY**  
SSQ-4499  
370 mm

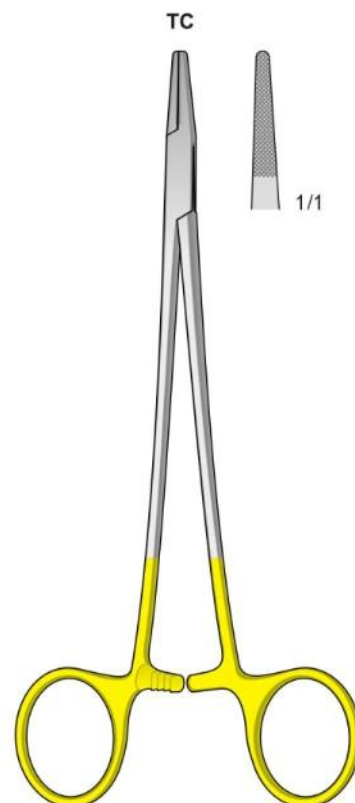

**DeBAKEY**  
SSQ-4500  
200 mm

Für Linkshänder - Left Handed  
Per mancini - Pour gauche - Para zurdos

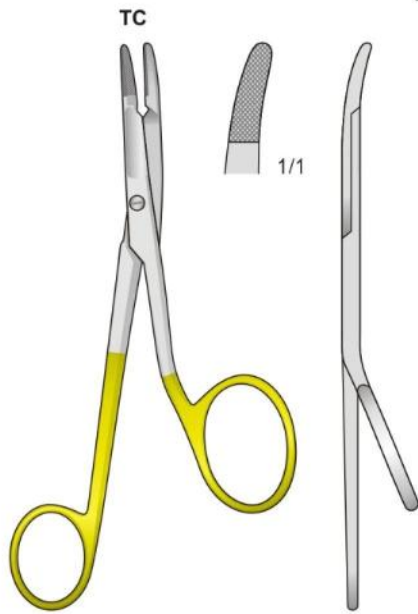

**GILLIES**  
SSQ-4501  
160 mm

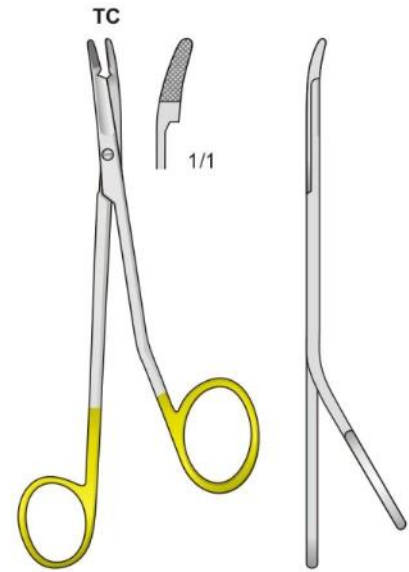

**MINI-GILLIES**  
SSQ-4502  
145 mm

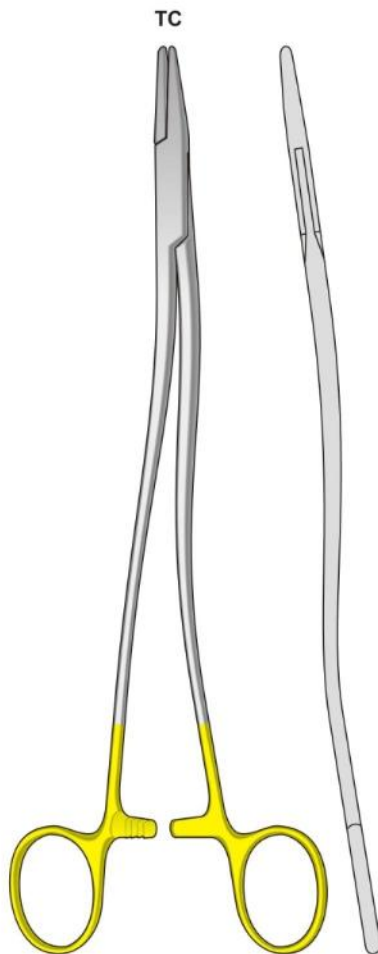

**BOZEMANN**  
SSQ-4503

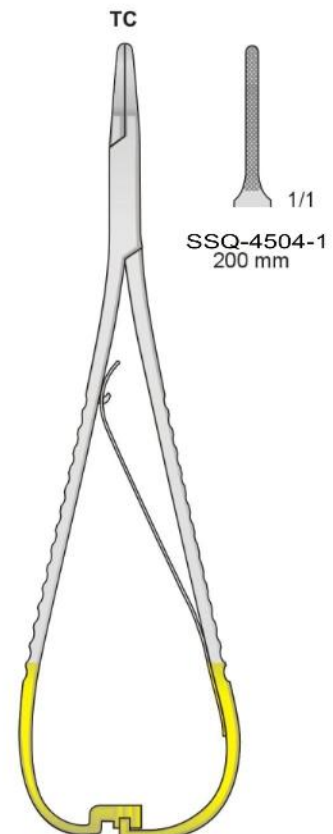
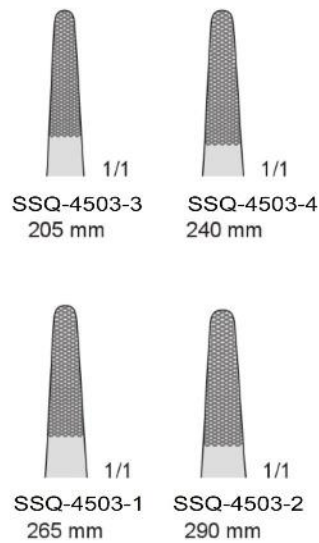

**LICHTENBERG**  
SSQ-4504  
175 mm

Kräftiges Modell  
Heavy pattern  
Modello robusto  
Modèle robuste

TC

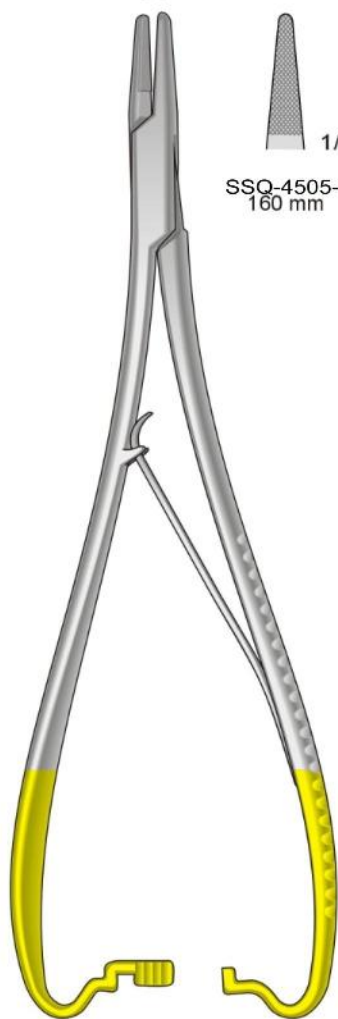

MATHIEU  
SSQ-4505

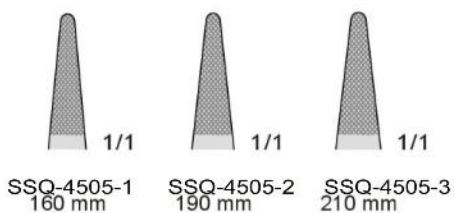

Atraumatische - Atraumatic  
Atraumatiche - Atraumáticas  
Atraumatique

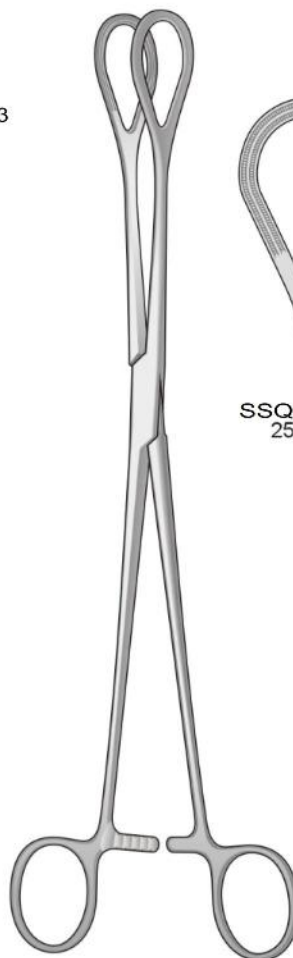

SSQ-4506

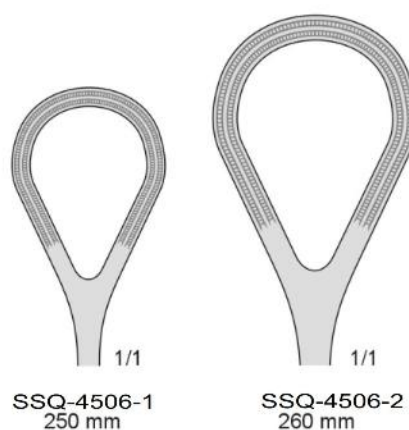



MINI-LANGENBECK  
SSQ-4507  
160 mm

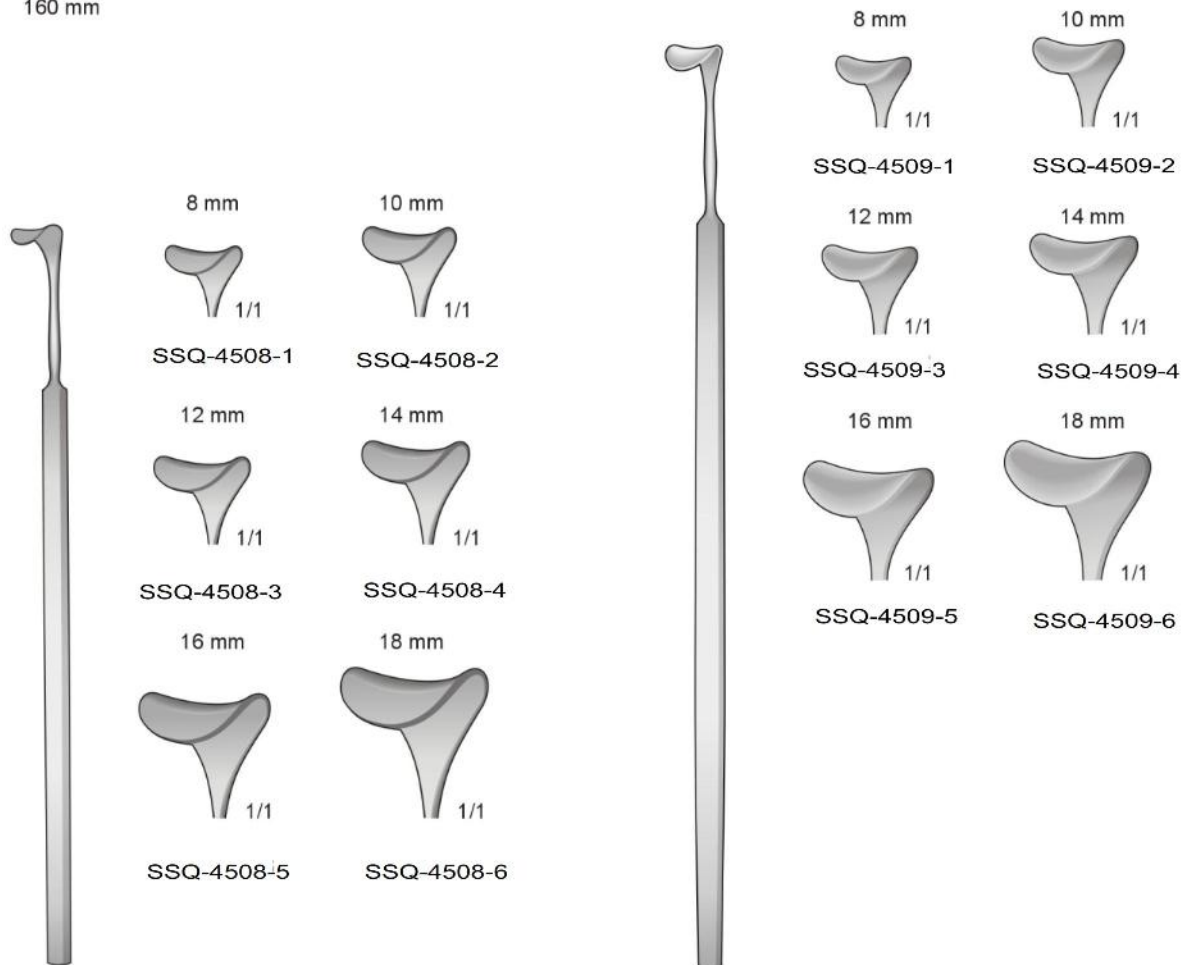

CUSHING  
SSQ-4508  
200 mm

CUSHING  
SSQ-4509  
240 mm

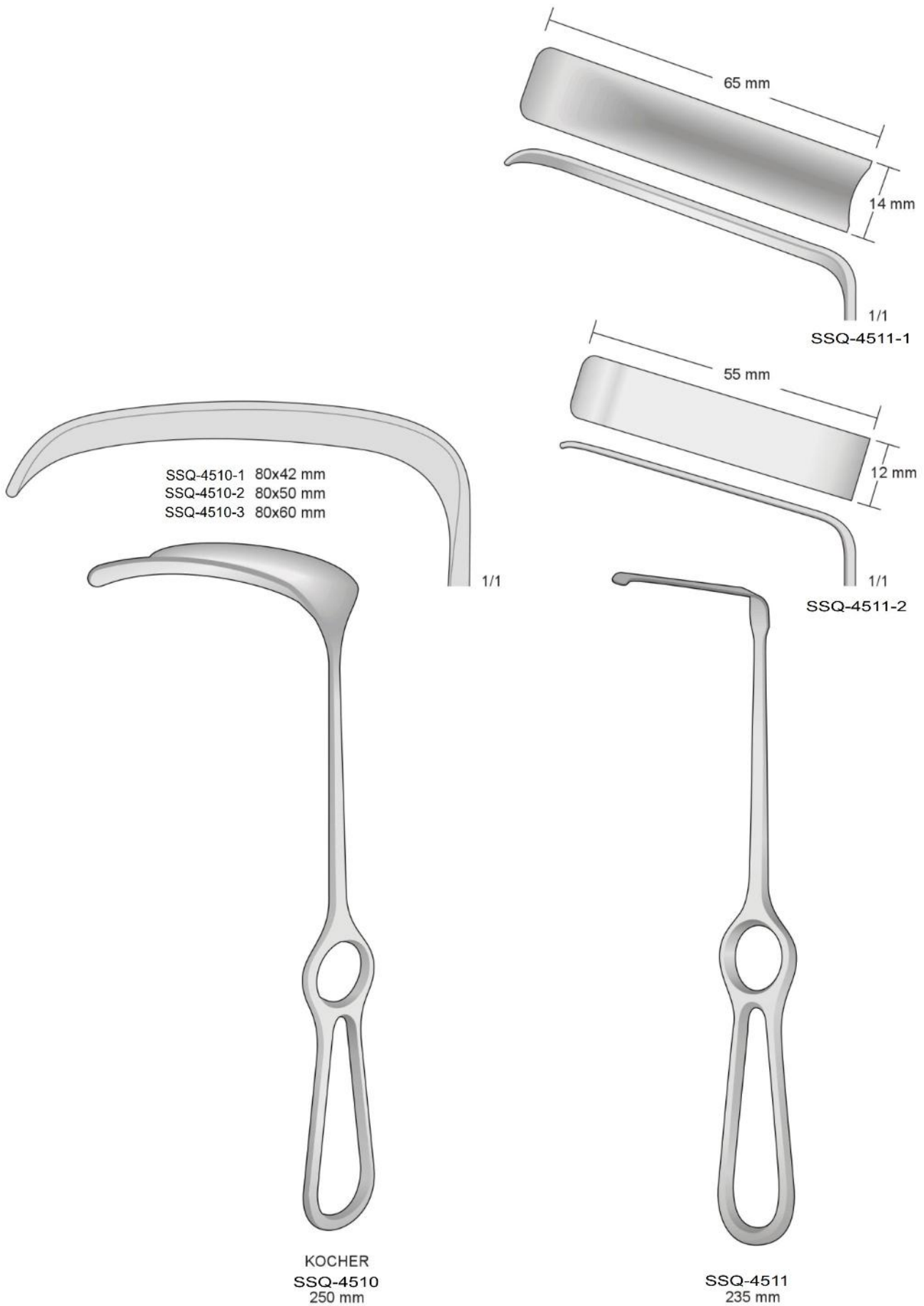

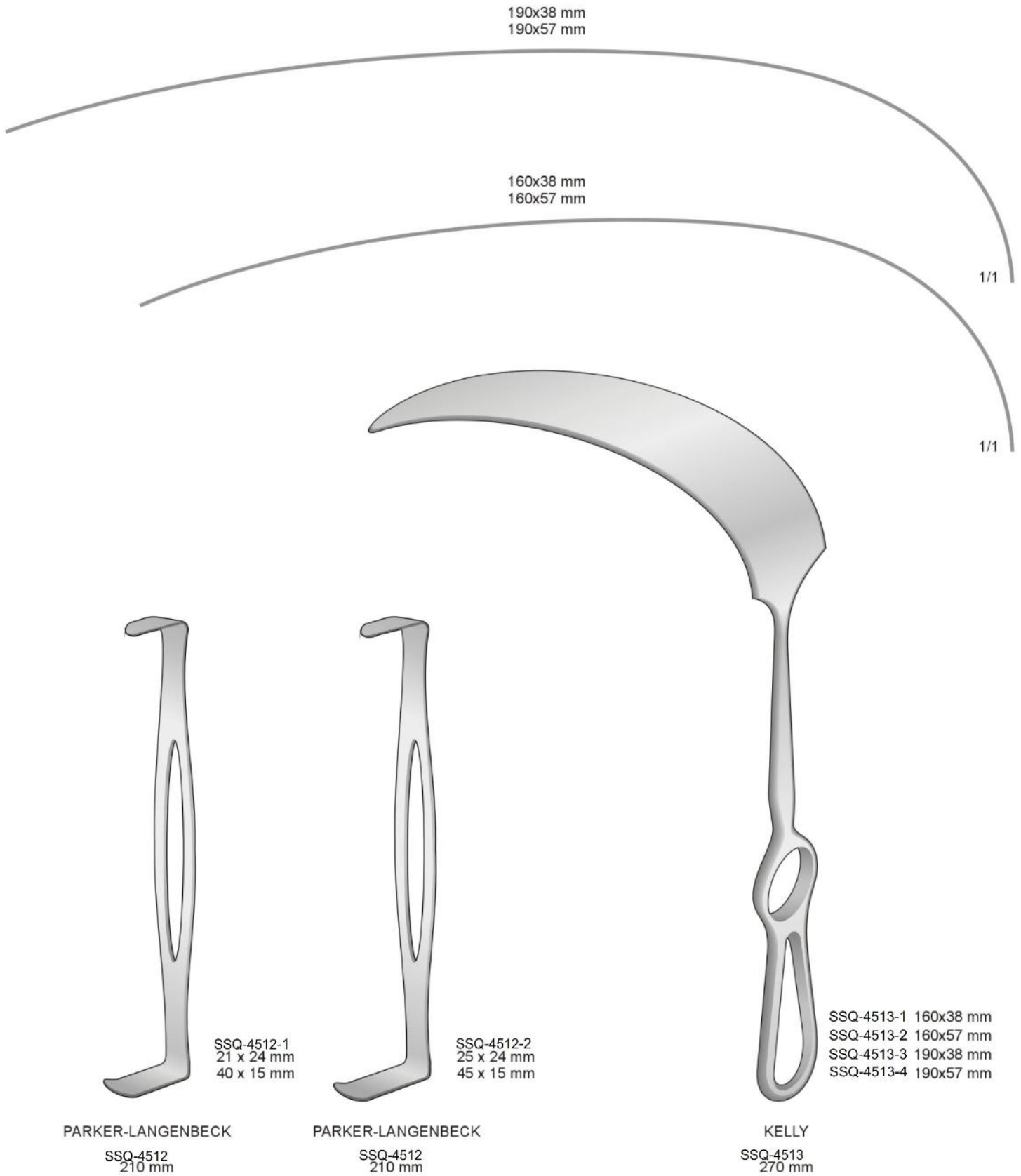

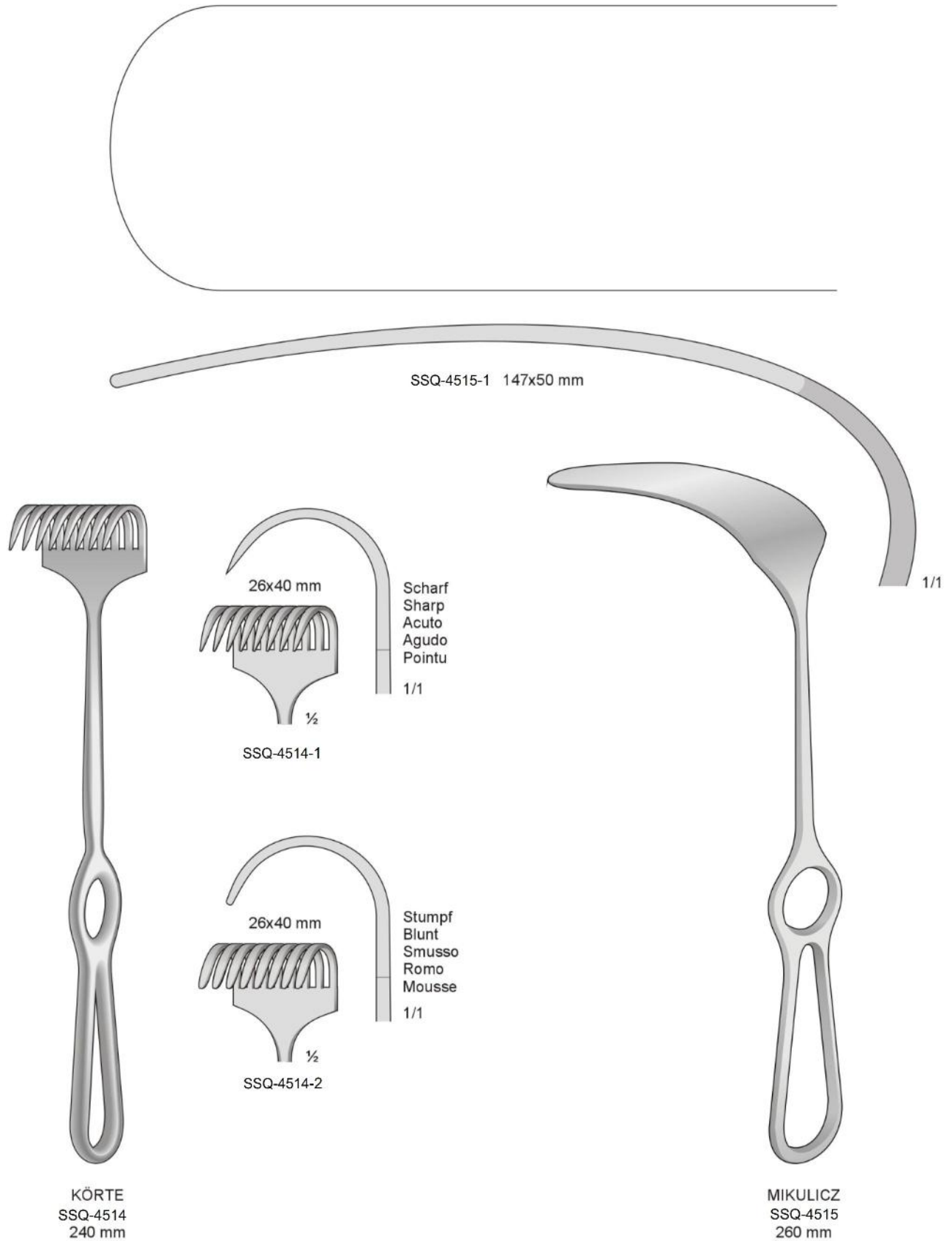

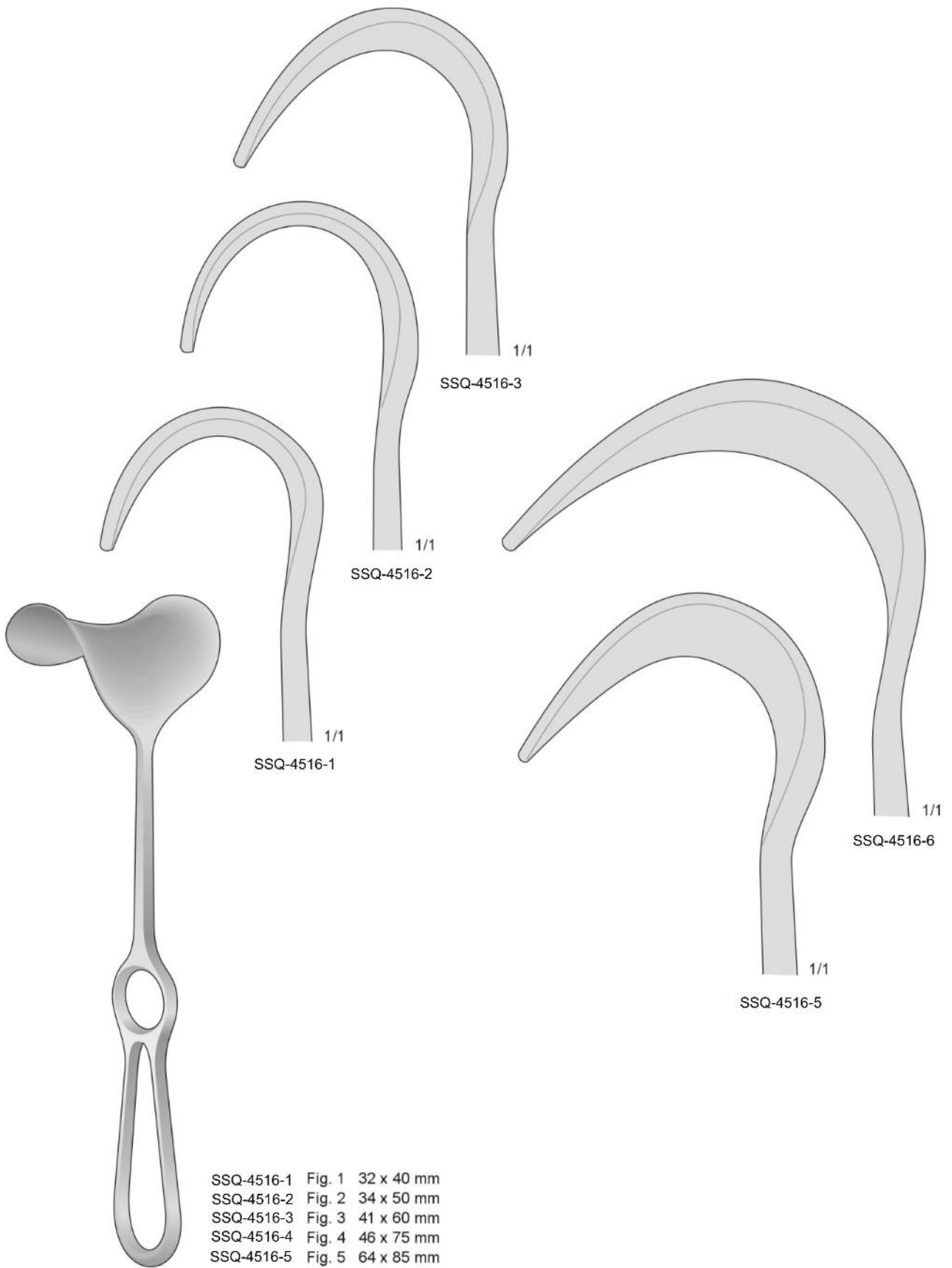

FRITSCH  
SSQ-4516  
240 mm



Pelvishaken  
Pelvis retractors

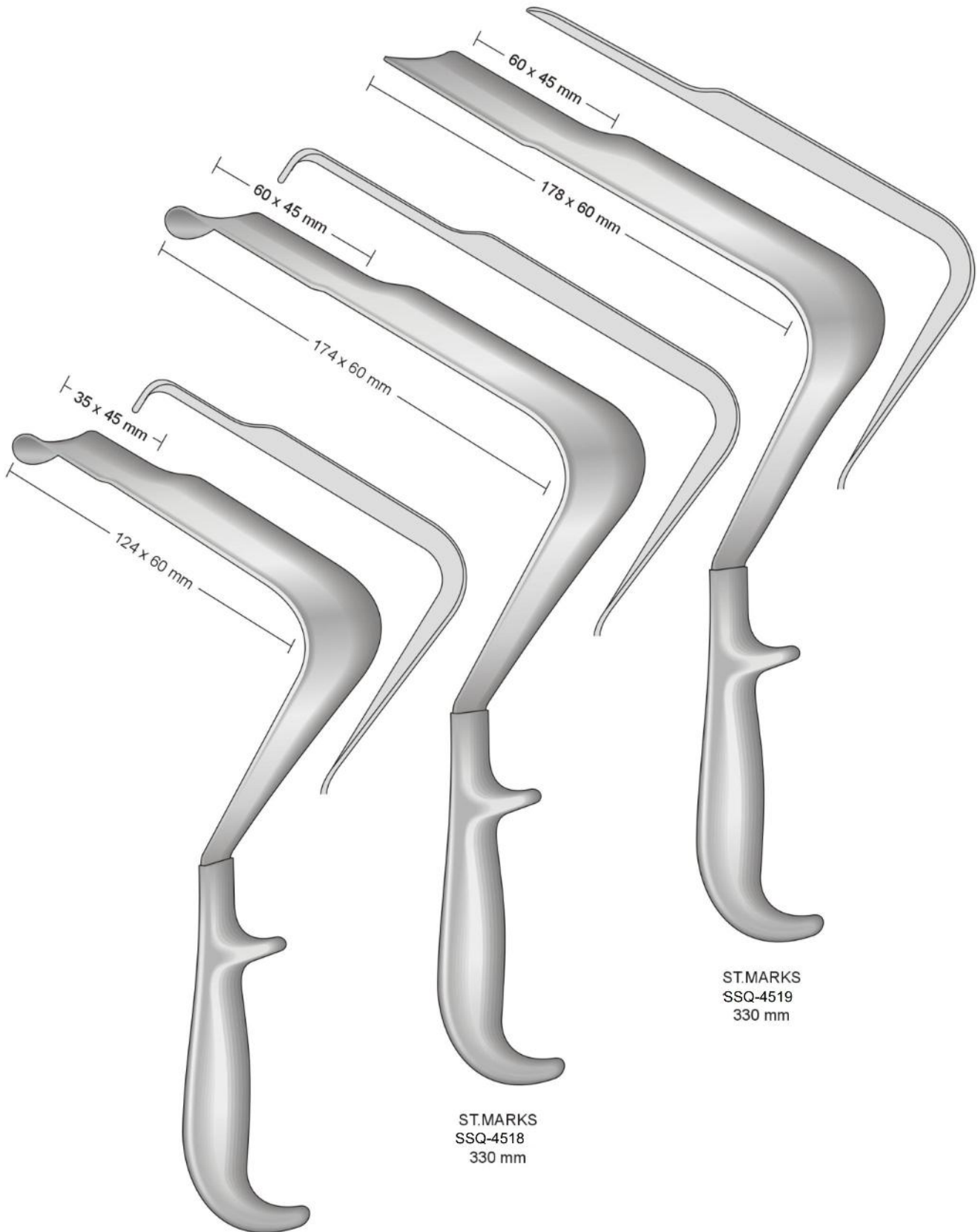

ST.MARKS  
SSQ-4519  
330 mm

ST.MARKS  
SSQ-4518  
330 mm

ST.MARKS  
SSQ-4517  
290 mm

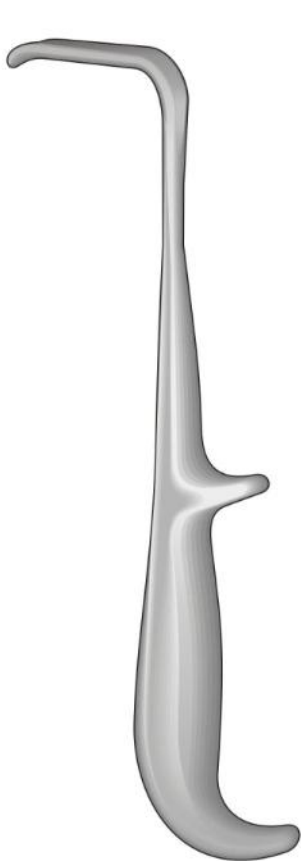
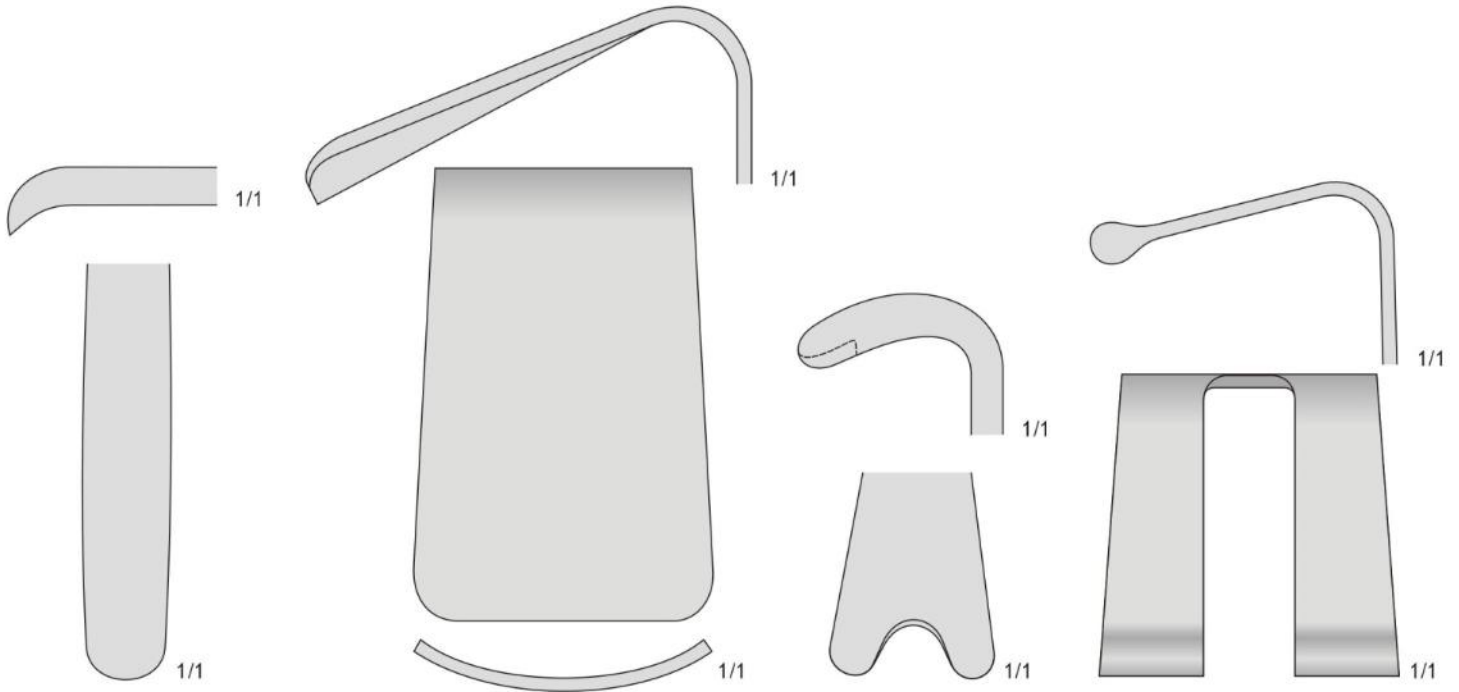

YOUNG  
SSQ-4520  
215 mm

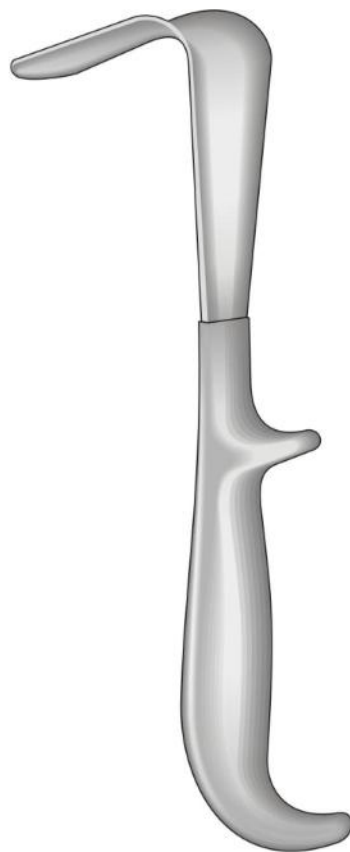

YOUNG  
SSQ-4521  
210 mm

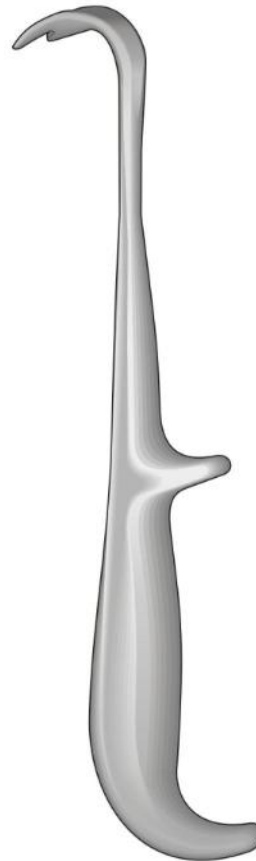

YOUNG  
SSQ-4522  
220 mm

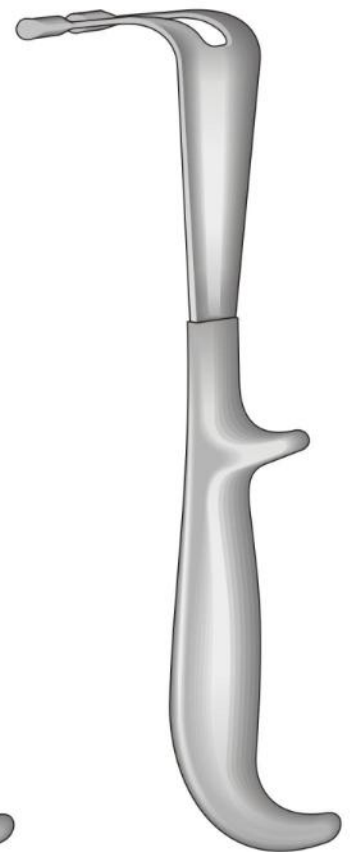

YOUNG  
SSQ-4523  
210 mm

new

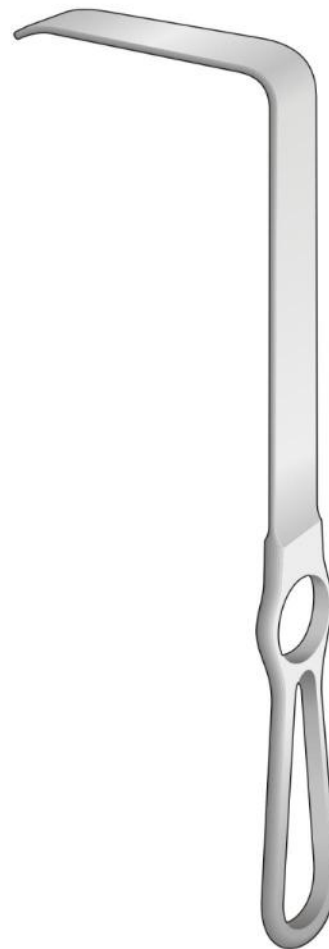
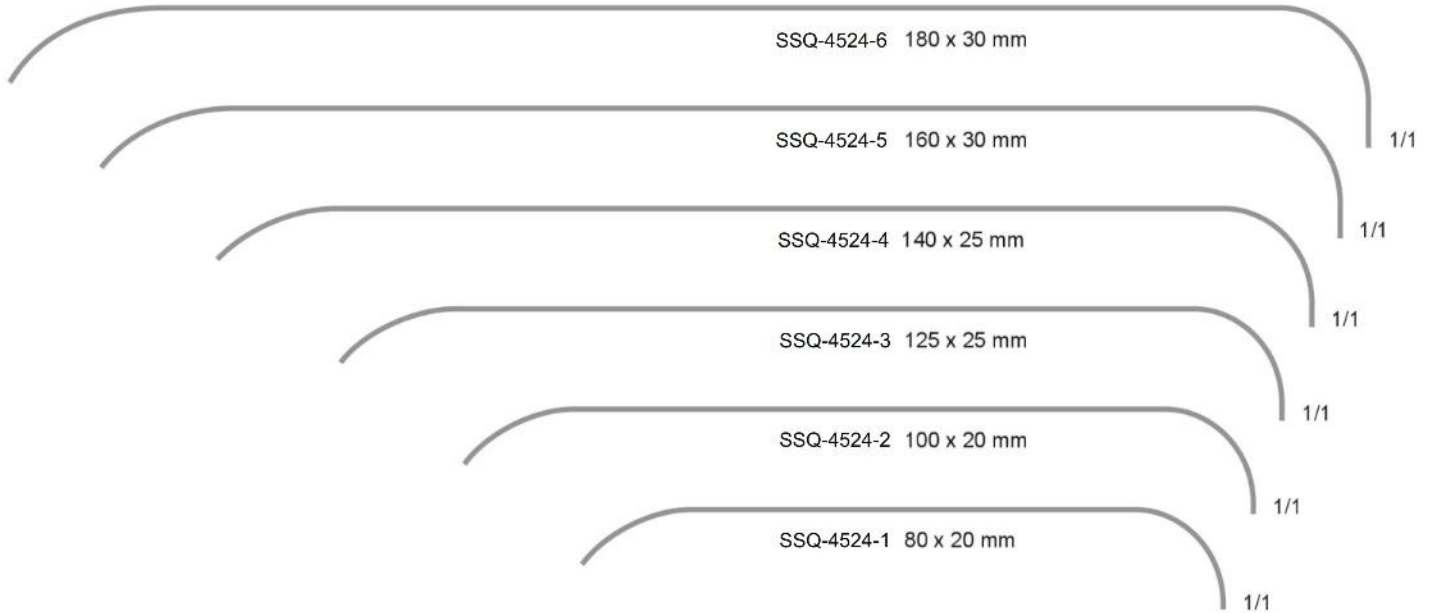

BRUNNER  
SSQ-4524  
250 mm

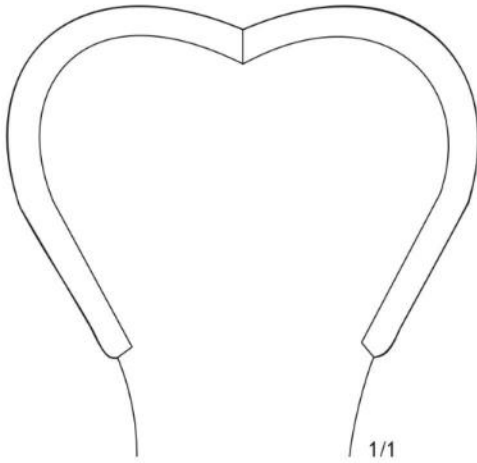

HARRINGTON-PEMBERTON  
SSQ-4525 175 x 64 mm  
295 mm

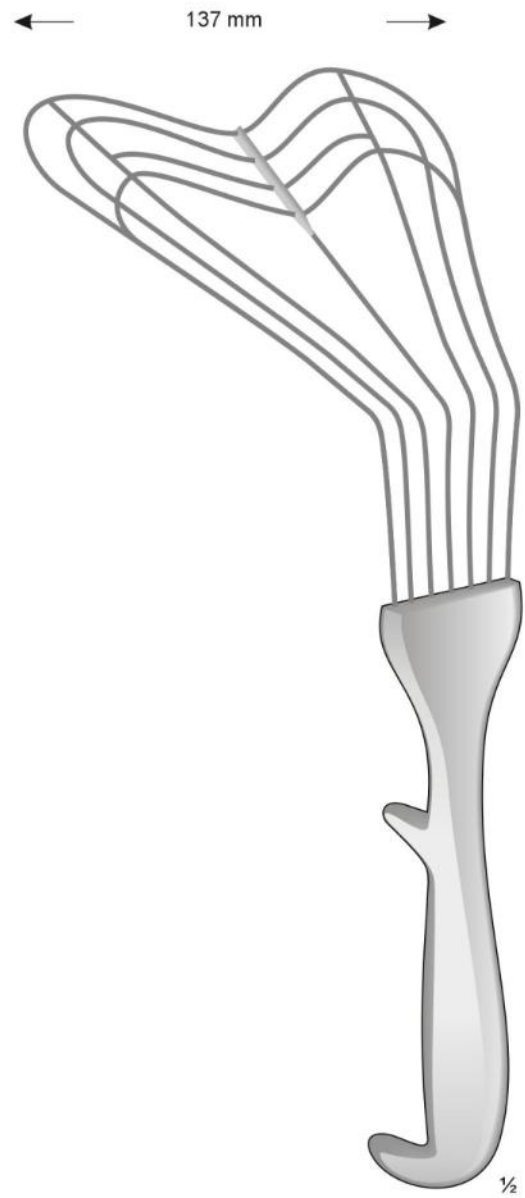

SSQ-4526  
300 mm

Gefäßclips - Vessel Clips  
Clamps vascolari - Clamps vasculares  
Clamps vasculaires

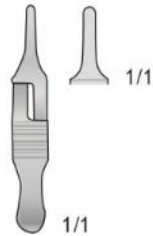

DIEFFENBACH  
SSQ-4527  
30 mm

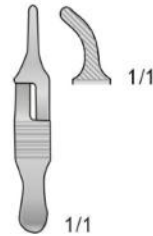

DIEFFENBACH  
SSQ-4528  
30 mm

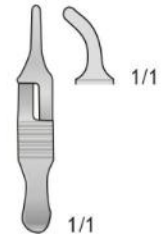

DIEFFENBACH  
SSQ-4529  
30 mm

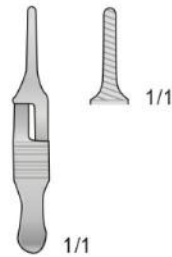

DIEFFENBACH  
SSQ-4530  
30 mm

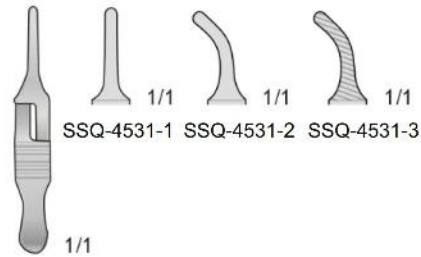

DIEFFENBACH  
SSQ-4531  
35 mm

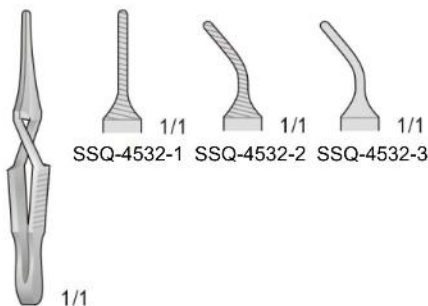

SSQ-4532  
40 mm

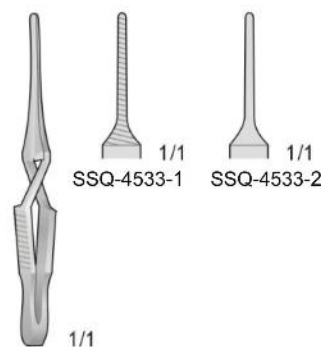

SSQ-4533  
45 mm

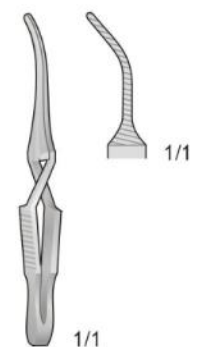

45 mm

Komplettsset mit 3 Haken Stripper - Set complete with 3 Vein Stripper  
Set completo con 3 uncini per vene - Set completo con 3 sondas para verices  
Set complete avec 3 stripper a anneau

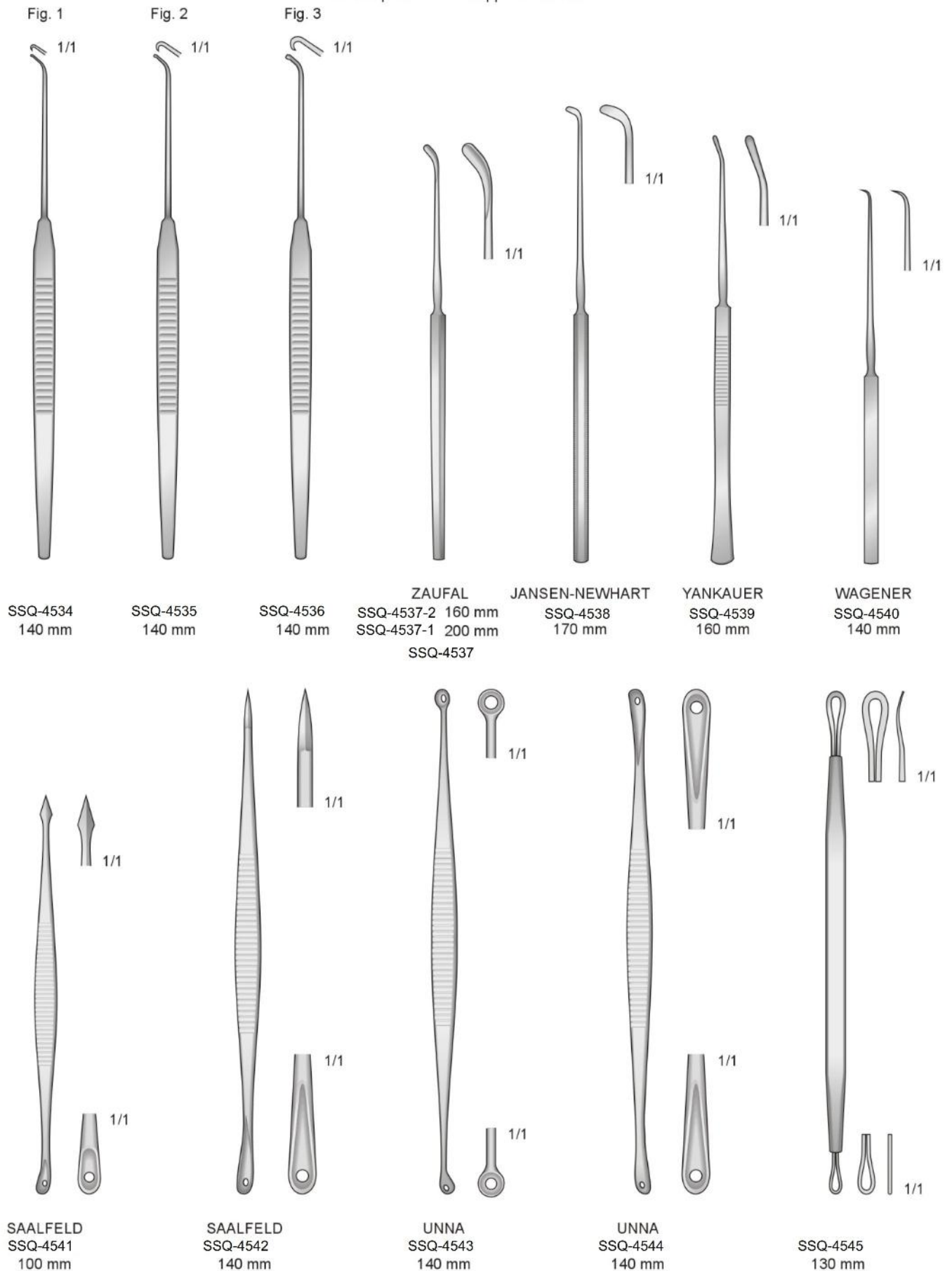

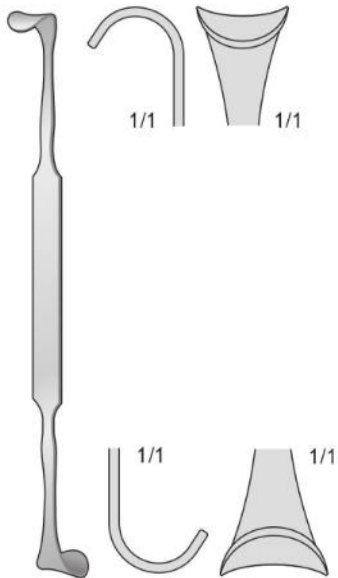

ROSE  
SSQ-4546  
130 mm

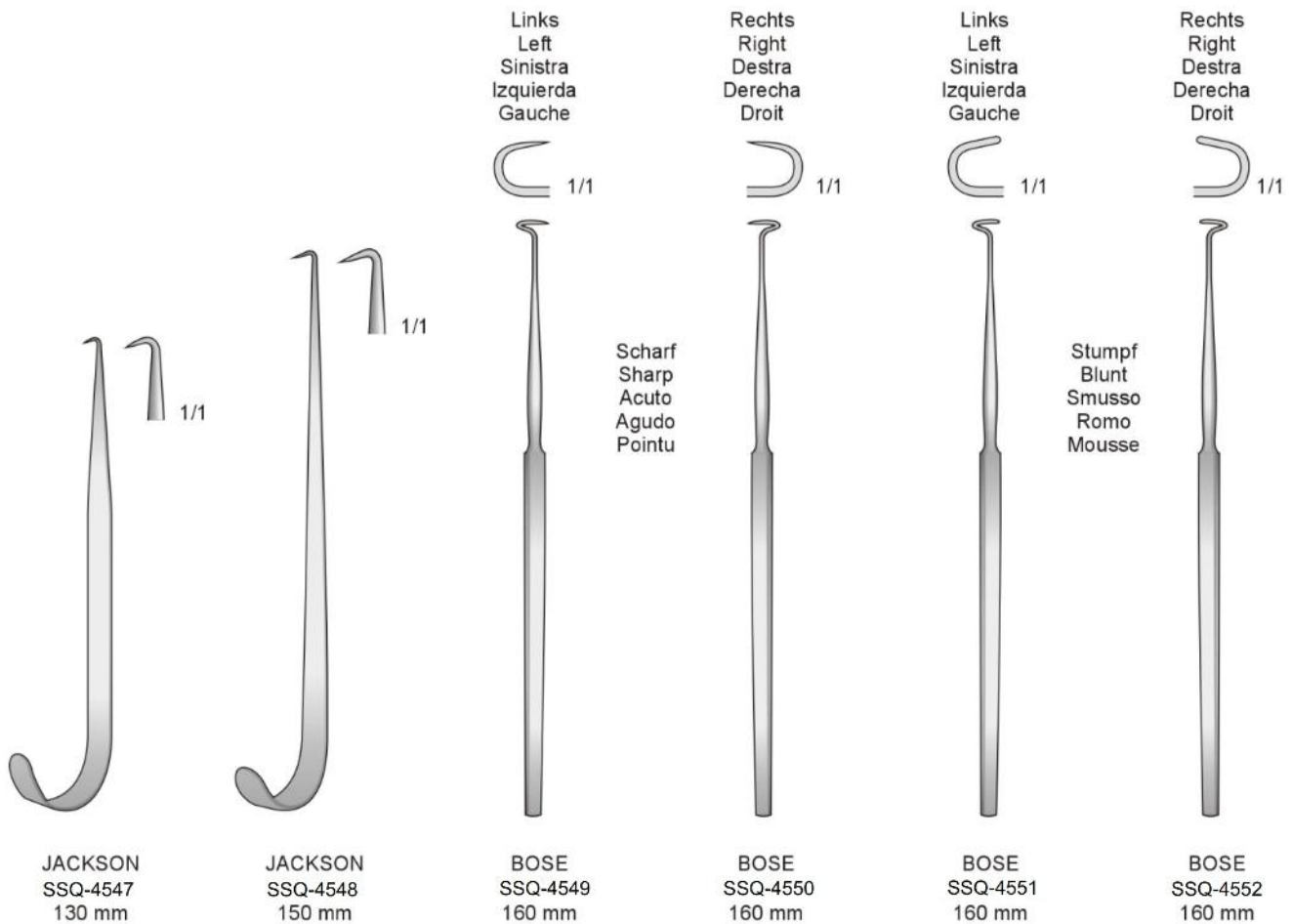

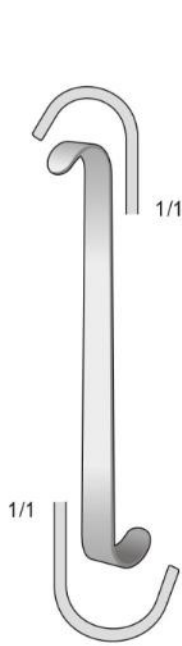

LUER  
SSQ-4553  
110 mm

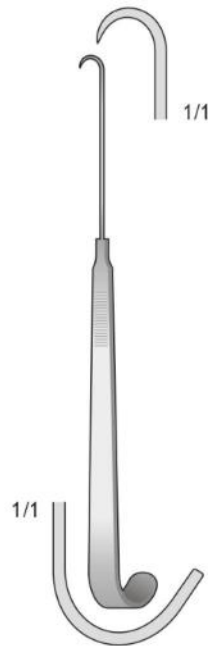

NEWS  
SSQ-4554  
150 mm

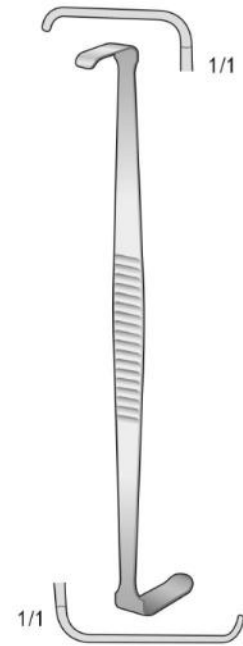

HOUSE  
SSQ-4555  
150 mm

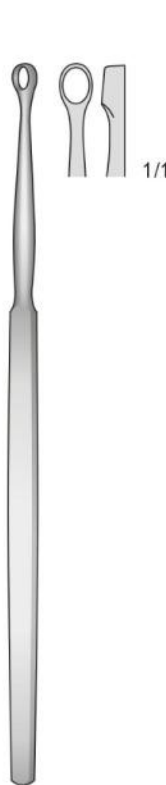

FOX  
SSQ-4556  
140 mm

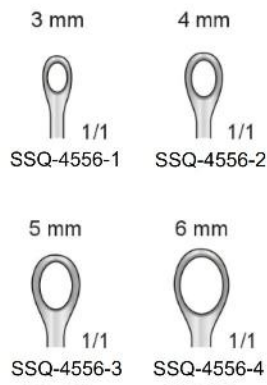

WOLF  
SSQ-4557  
140 mm

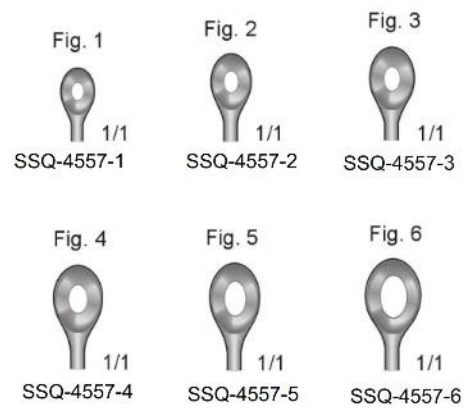



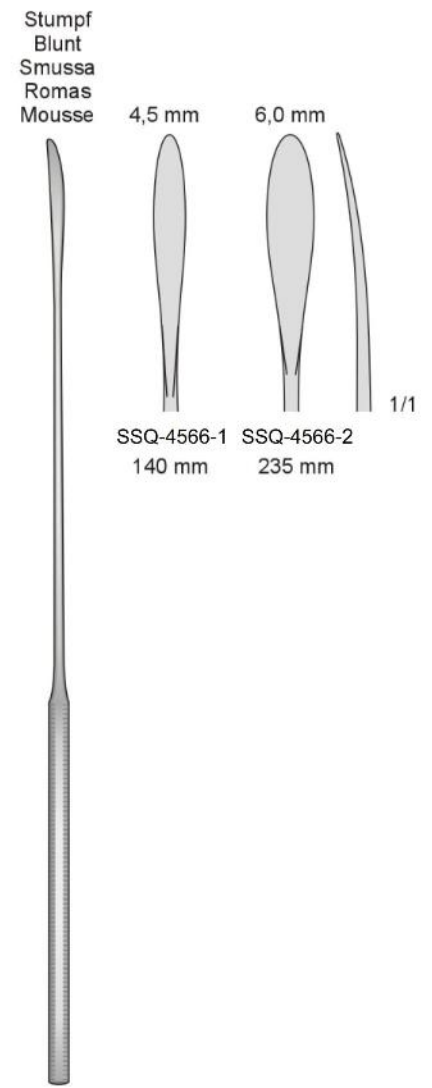
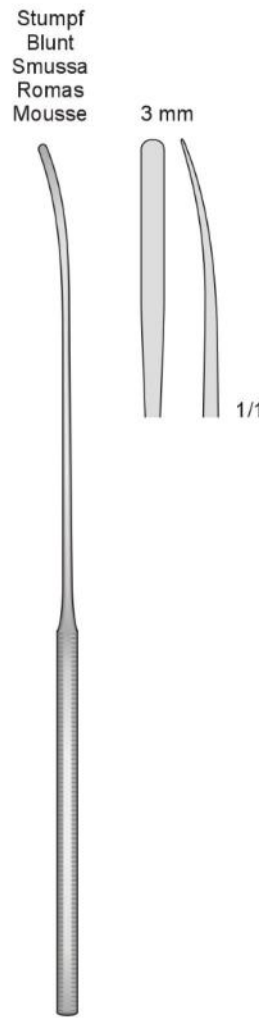
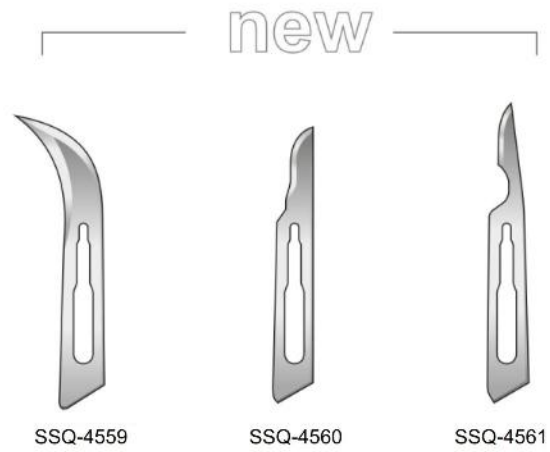
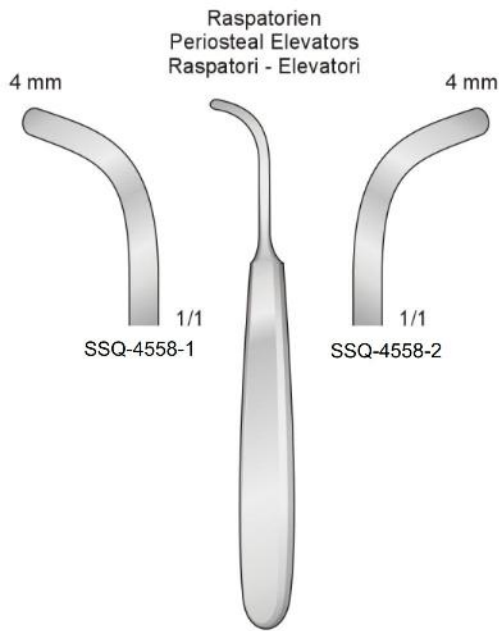

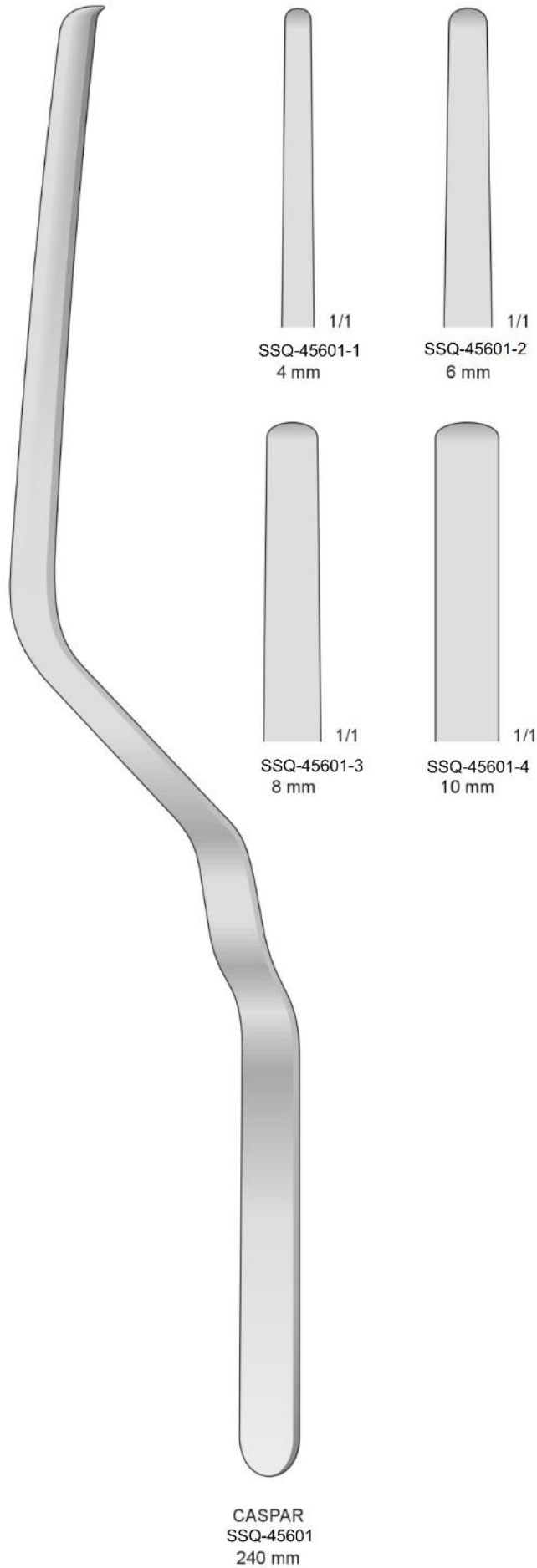

Femur-Wundspreizer für kinder  
Femur Retractor for children  
Divaricatore femorale per bambini

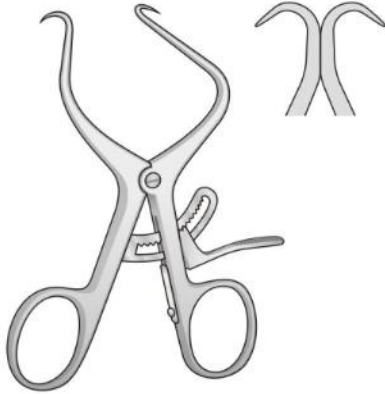

DE BAKEY  
SSQ-45602  
100 mm

Femur-Wundspreizer  
Femur Retractor  
Divaricatore femorale

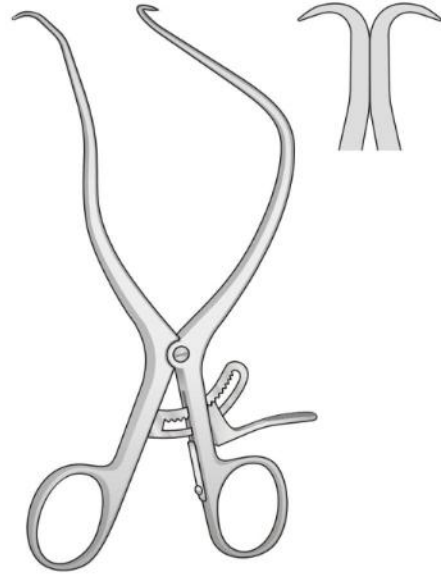

DE BAKEY  
SSQ-45603  
170 mm

Wundspreizer  
Retractors for shoulder  
Divaricatori da spalla  
Separadores  
Ecarteurs

Stumpf - Blunt  
Smusso - Romo  
Mousse

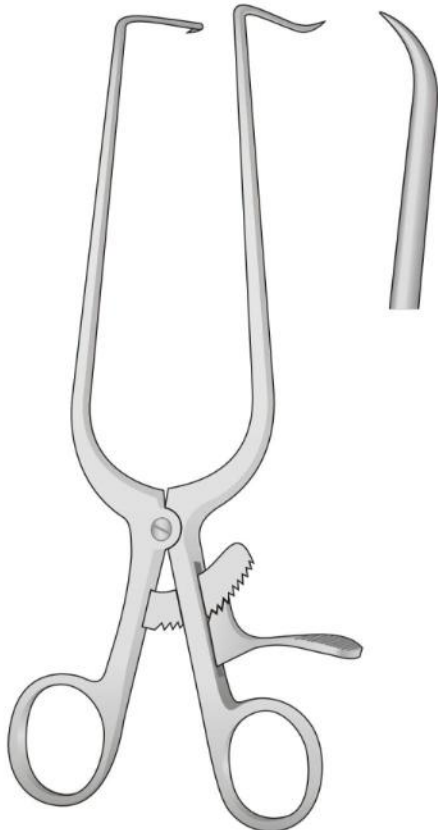

SSQ-45604  
215 mm

Stumpf - Blunt  
Smusso - Romo  
Mousse

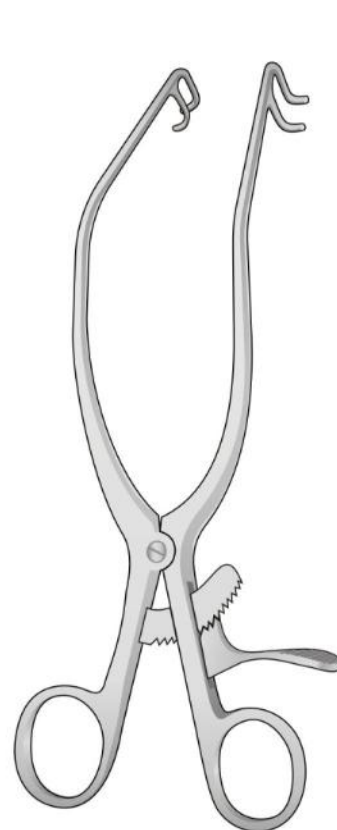

KÖLBEL  
SSQ-45605  
180 mm

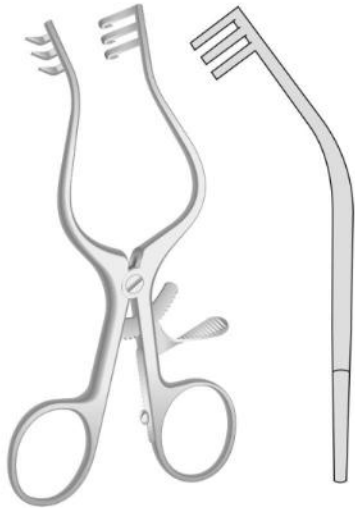
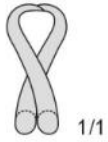

Scharf  
Sharp  
Acuto  
Agudo  
Pointu

WULLSTEIN  
SSQ-4569  
130 mm

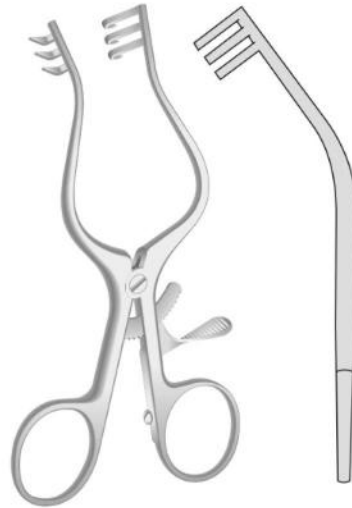
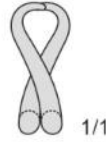

Stumpf  
Blunt  
Smusso  
Romo  
Mousse

WULLSTEIN  
SSQ-4570  
130 mm

Scharf  
Sharp  
Acuto  
Agudo  
Pointu

Stumpf  
Blunt  
Smusso  
Romo  
Mousse

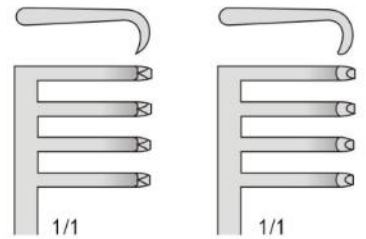

SSQ-4568-1

SSQ-4568-2

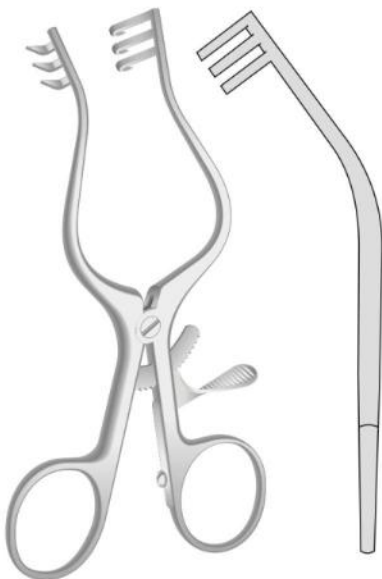
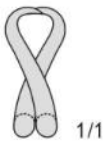

Scharf  
Sharp  
Acuto  
Agudo  
Pointu

WULLSTEIN  
SSQ-4566  
160 mm

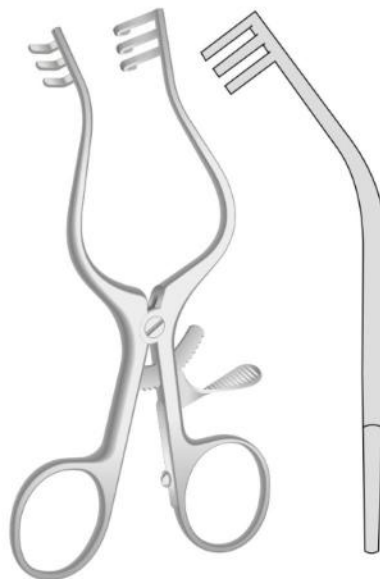

Stumpf  
Blunt  
Smusso  
Romo  
Mousse

WULLSTEIN  
SSQ-4567  
160 mm



SCALP-CONTOUR  
SSQ-4568  
135 mm

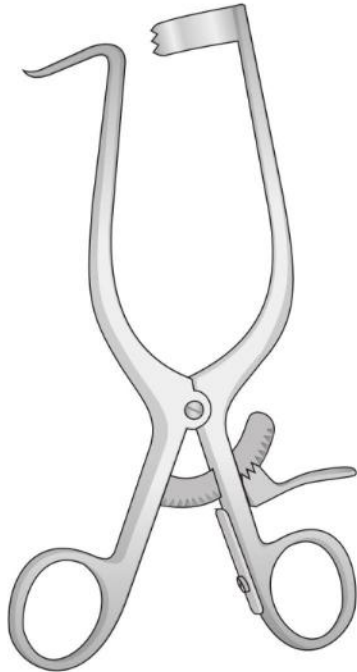

WILLIAMS  
SSQ-4572  
170 mm

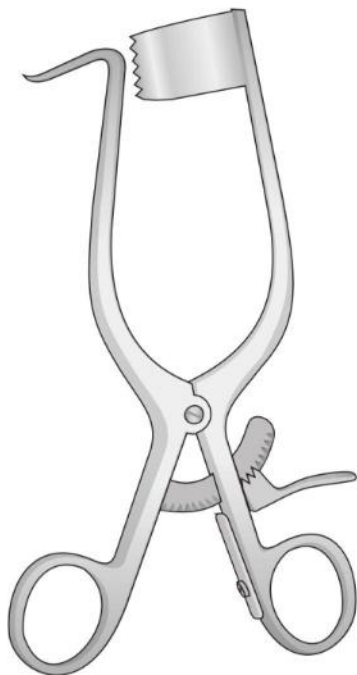

WILLIAMS  
SSQ-4571  
170 mm

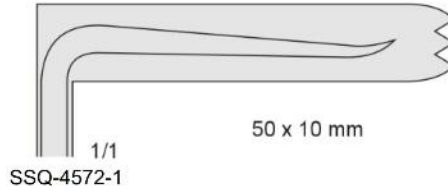

SSQ-4572-1

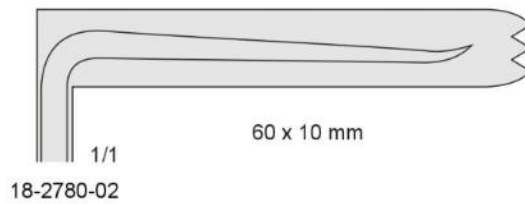

18-2780-02

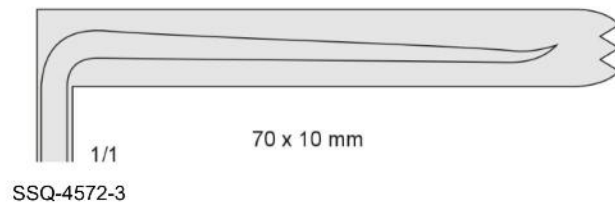

SSQ-4572-3

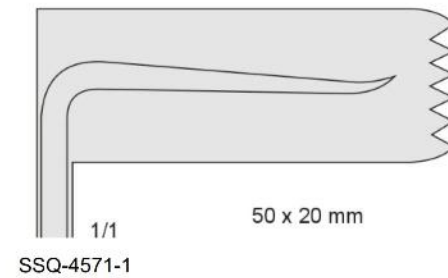

SSQ-4571-1

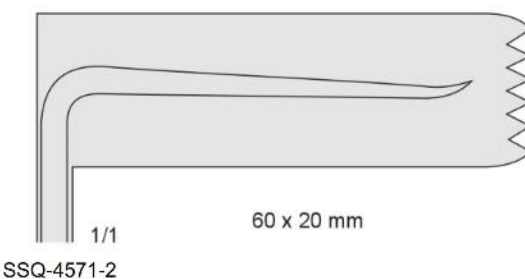

SSQ-4571-2

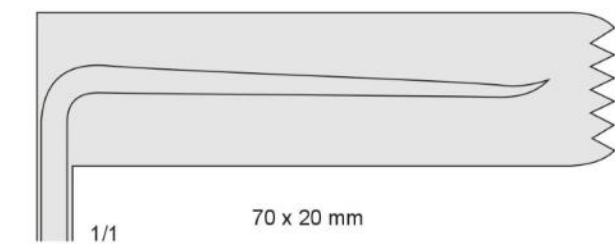

SSQ-4571-3

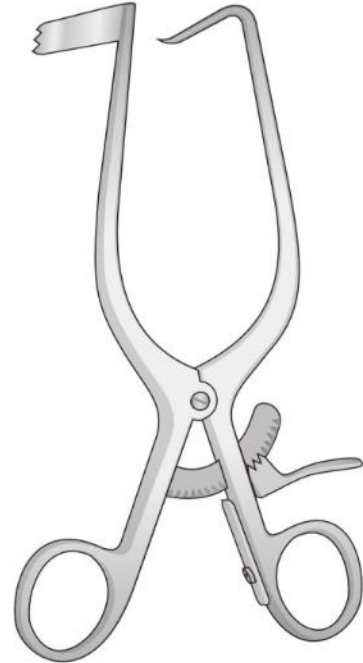
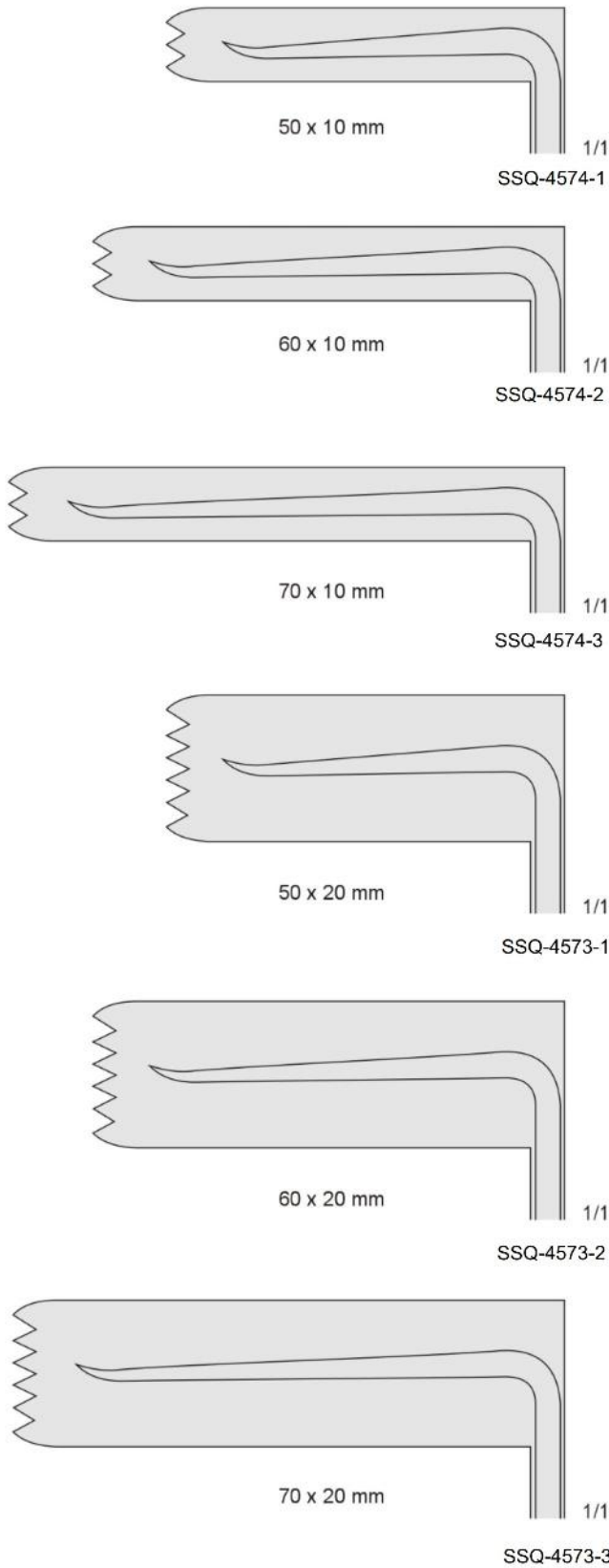

WILLIAMS  
SSQ-4574  
170 mm

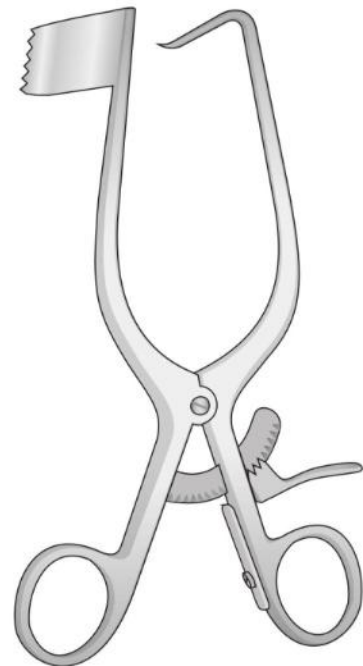

WILLIAMS  
SSQ-4573  
170 mm

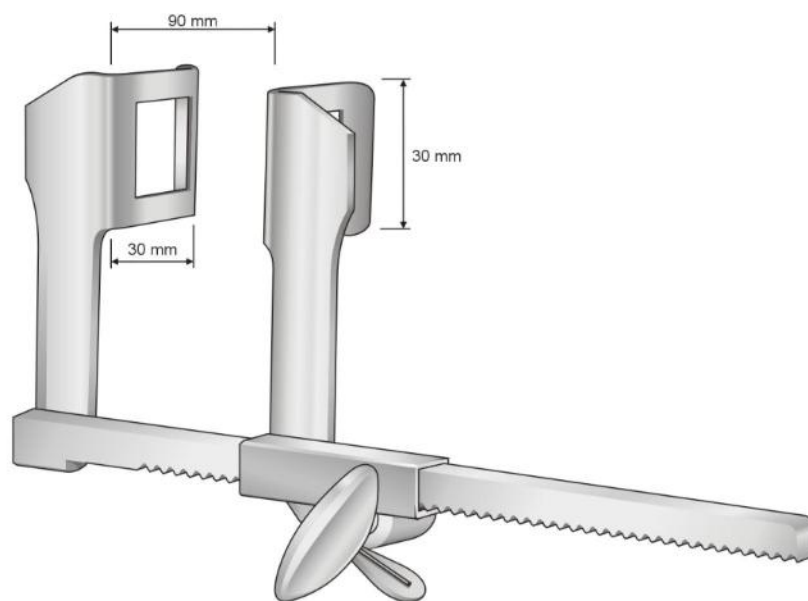

HAIGHT  
SSQ-4575

CASPAR  
SSQ-4578  
Distraktor komplett rechts  
Distractor complete right  
Distrattore completo destro  
SSQ-4578-1 Distraktor allein - 1 Distractor only  
SSQ-4578-2 Bohrbüchse - 1 Drilling Guide  
SSQ-4578-3 Spezialbohrer - 1 Special Drill  
SSQ-4578-4 Distractionsschrauben - 2 Distraction Screws  
SSQ-4578-5 Schraubendreher - 1 Screw Driver

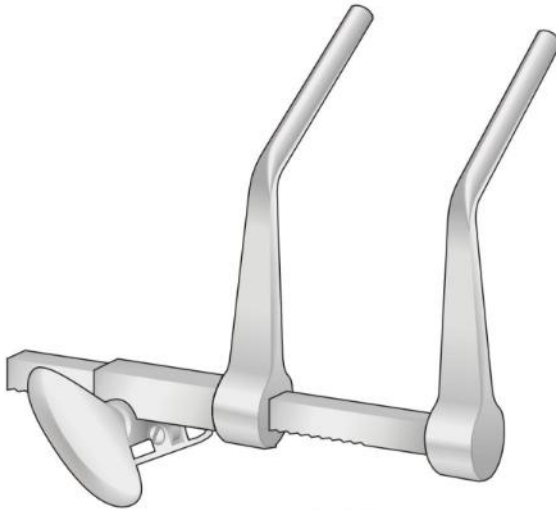

CASPAR  
SSQ-4578  
Distraktor rechts, Allein  
Distractor right, Only  
Distrattore destro, solo

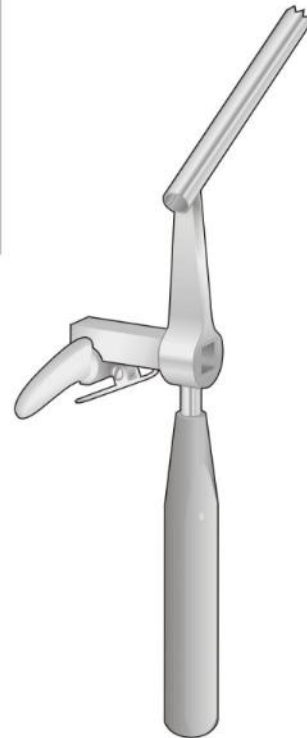

SSQ-4579  
Bohrbüchse rechts, Allein  
Drilling Guide right, Only  
Guida punte destro, solo

CASPAR  
SSQ-4576  
Distraktor komplett links  
Distractor complete left  
Distrattore completo sinistro  
SSQ-4576-1 Distraktor allein - 1 Distractor only  
SSQ-4576-2 Bohrbüchse - 1 Drilling Guide  
SSQ-4576-3 Spezialbohrer - 1 Special Drill  
SSQ-4576-4 Distractionsschrauben - 2 Distraction Screws  
SSQ-4576-5 Schraubendreher - 1 Screw Driver

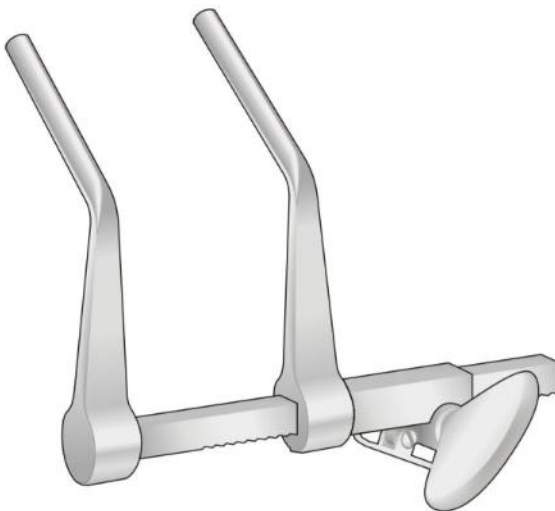

CASPAR  
SSQ-4576  
Distraktor links, Allein  
Distractor left, Only  
Distrattore sinistro, solo

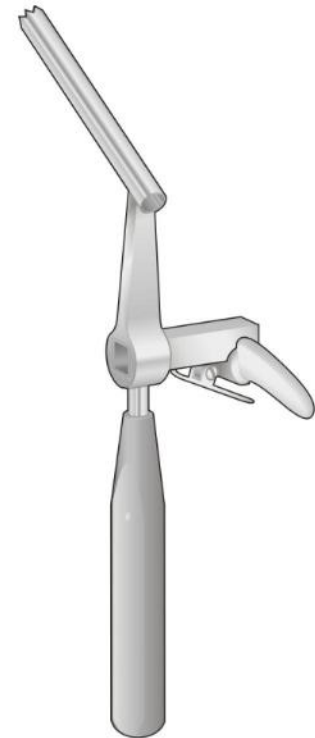

SSQ-4577  
Bohrbüchse links, Allein  
Drilling Guide left, Only  
Guida punte sinistro, solo



Screw Driver  
Schraubendreher



CASPAR  
SSQ-4582  
200 mm

Special Drill  
Spezialbohrer  
Ø 1,7 mm



CASPAR  
SSQ-4583  
145 mm

Distraction Screw  
Distractionsschrauben

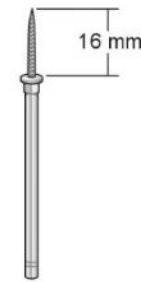

CASPAR  
SSQ-4584  
70 mm

- CASPAR
- Distraktor komplett links
  - Distractor complete left
  - Distrattore completo sinistro
  - 1 Distraktor allein - 1 Distractor only
  - 1 Bohrbüchse - 1 Drilling Guide
  - 1 Spezialbohrer - 1 Special Drill
  - 2 Distractionsschrauben - 2 Distraction Screws
  - 1 Schraubendreher - 1 Screw Driver

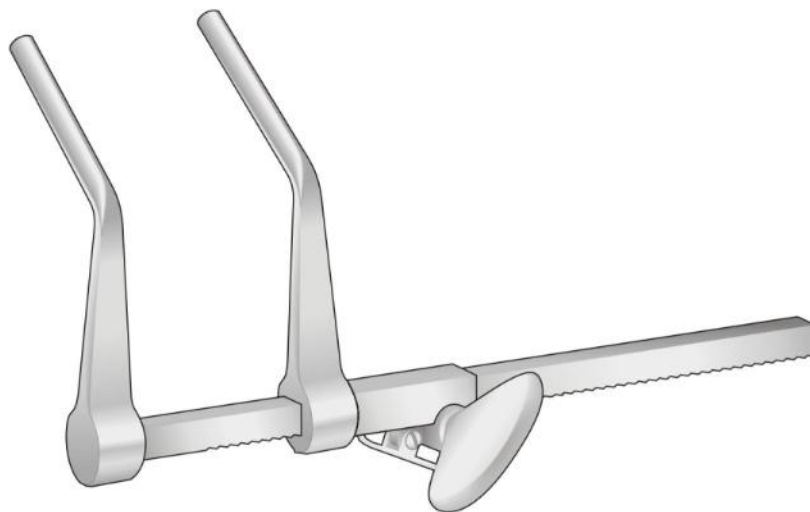

CASPAR  
SSQ-4580  
Distraktor links, Allein  
Distractor left, Only  
Distrattore sinistro, solo

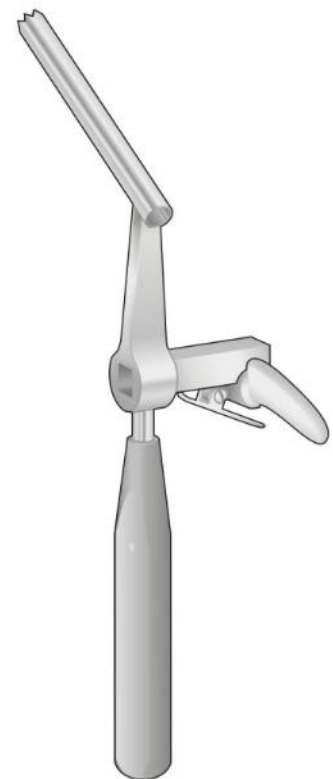

SSQ-4581  
Bohrbüchse links, Allein  
Drilling Guide left, Only  
Guida punte sinistro, solo

Special Drill  
Spezialbohrer  
Ø 1,7 mm

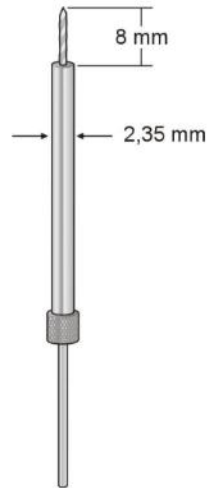

CASPAR  
SSQ-4586  
145 mm

Distraction Screw  
Distractionsschrauben

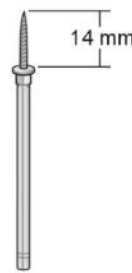

CASPAR  
SSQ-4587  
70 mm

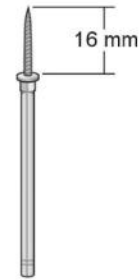

CASPAR  
SSQ-4588  
70 mm

Screw Driver  
Schraubendreher



CASPAR  
SSQ-4585  
200 mm

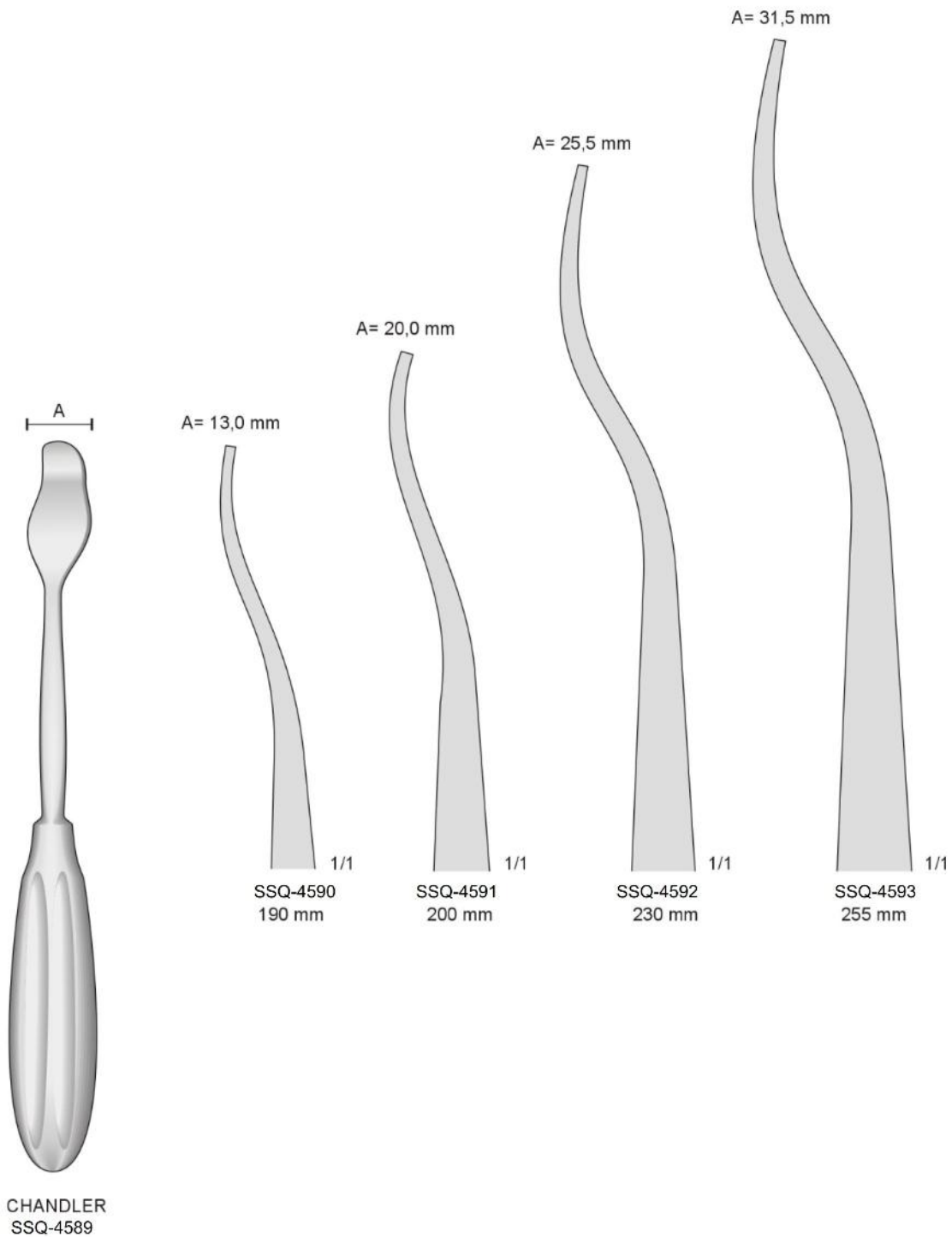

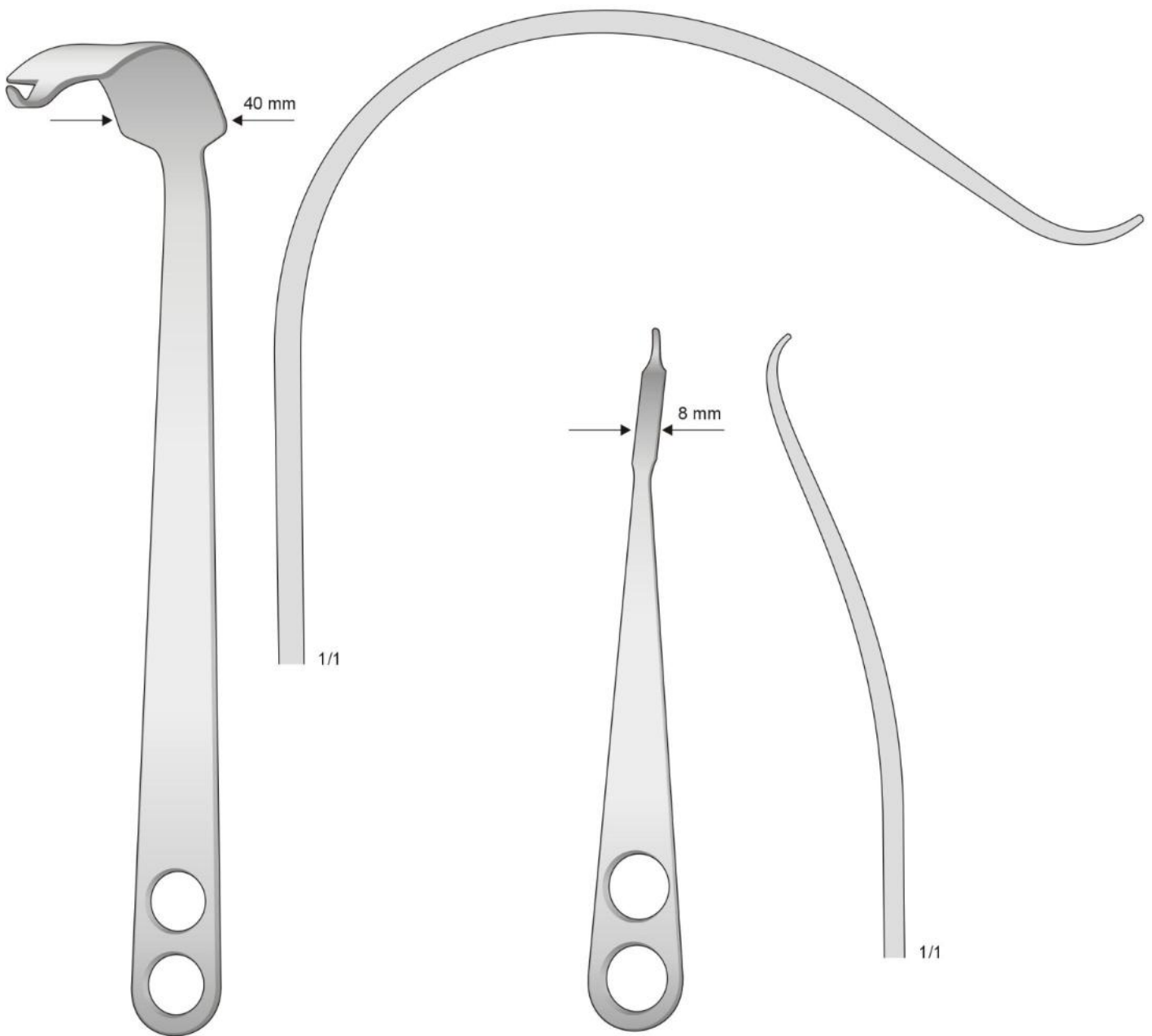

HOHMANN  
SSQ-4594  
330 mm

HOHMANN  
SSQ-4595  
225 mm

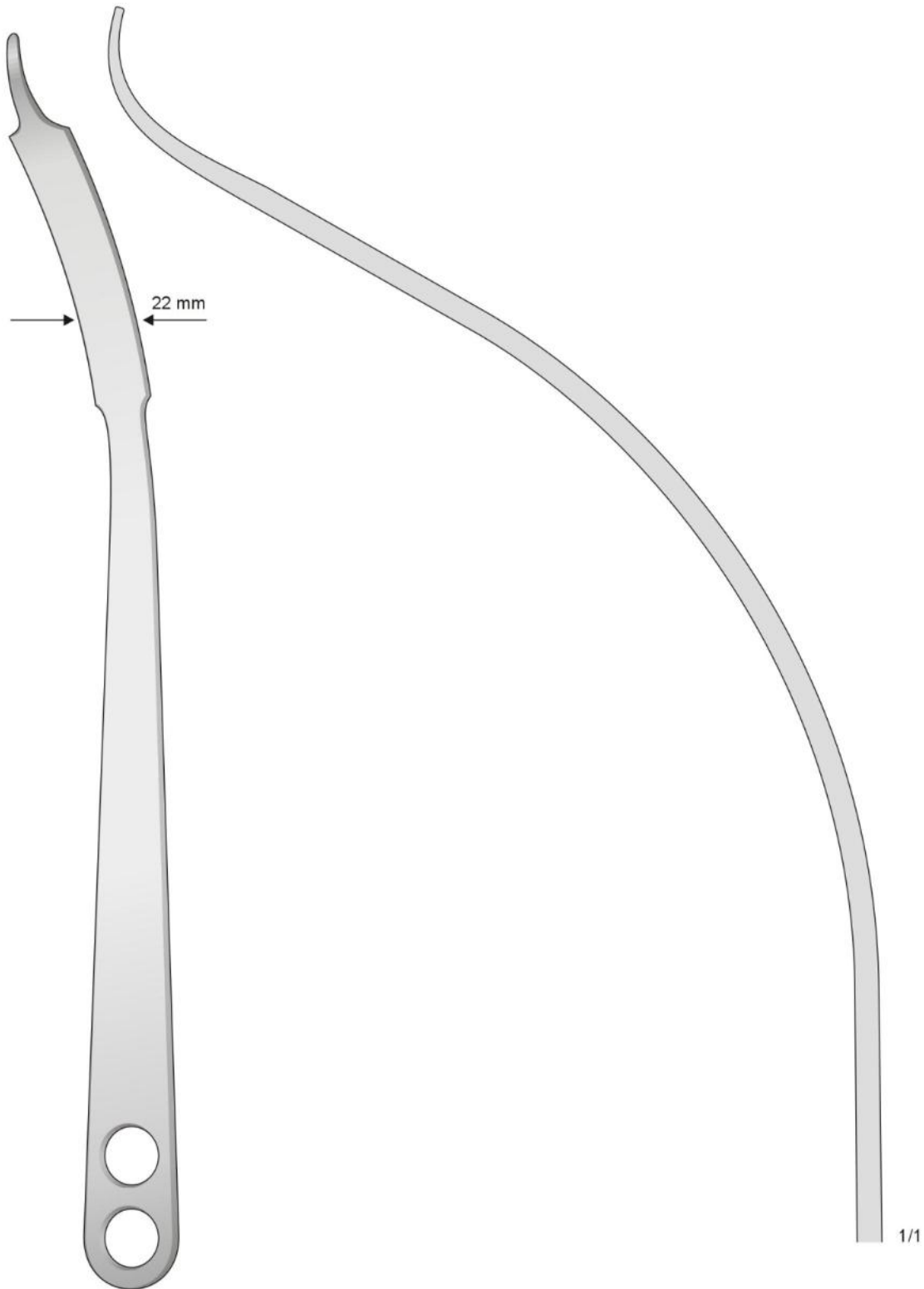

HOHMANN  
SSQ-4596  
400 mm

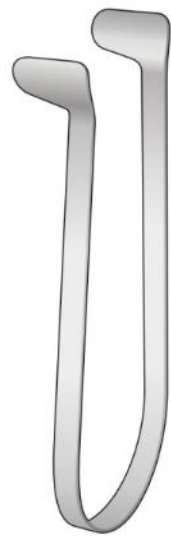

THUDICUM  
SSQ-4600

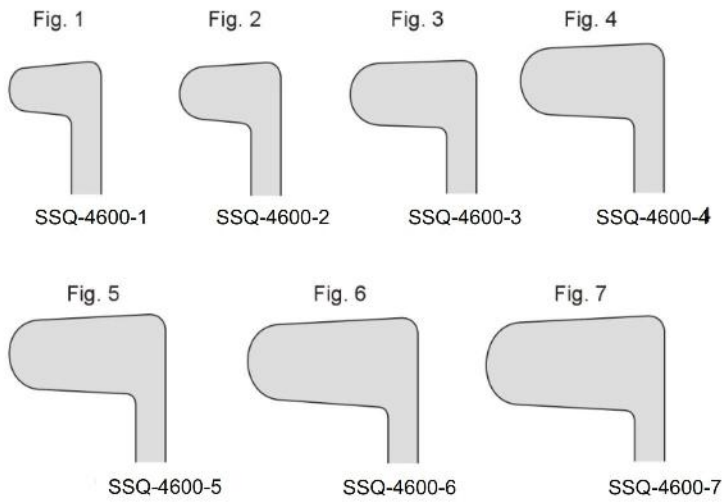

Zungenspatel - Tongue Depressor  
Adenotomie - Tonsillektomie

10 x 13 mm

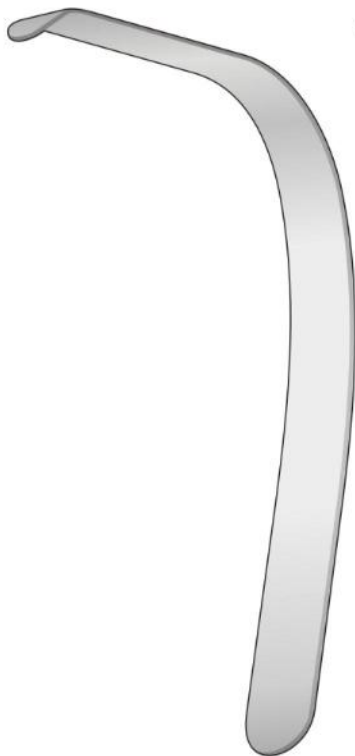

LACK  
SSQ-4597

13 x 19 mm



LACK  
SSQ-4598

15 x 22 mm

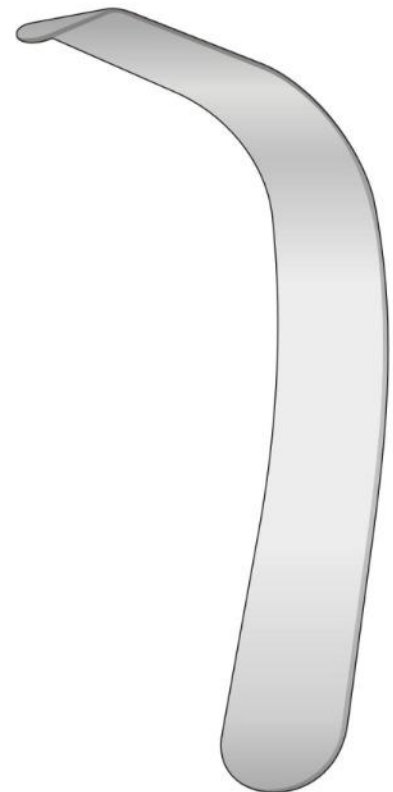

LACK  
SSQ-4599

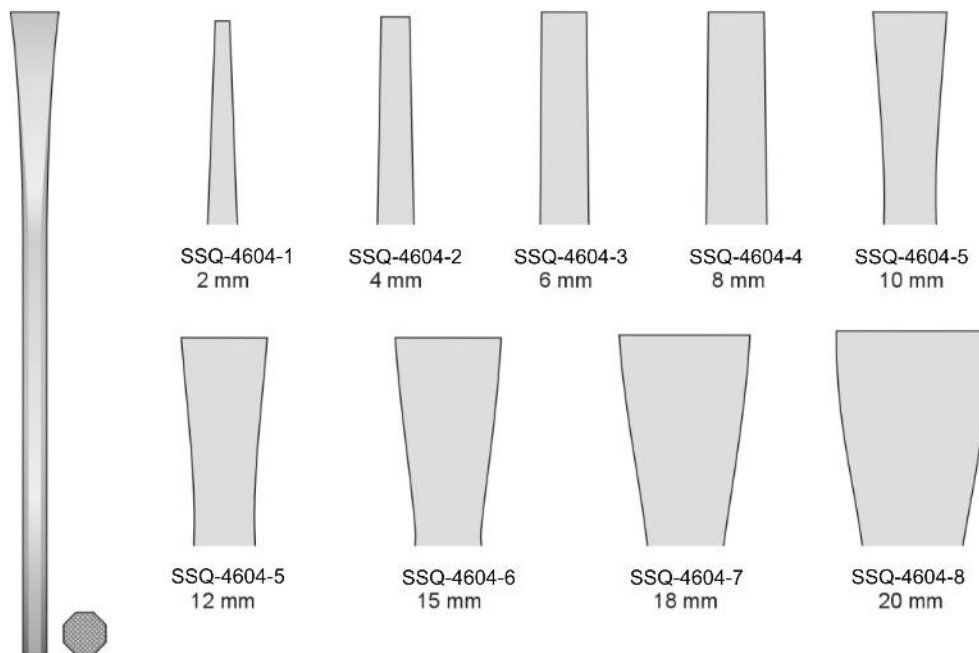

SHEEHAN  
SSQ-4604  
160 mm

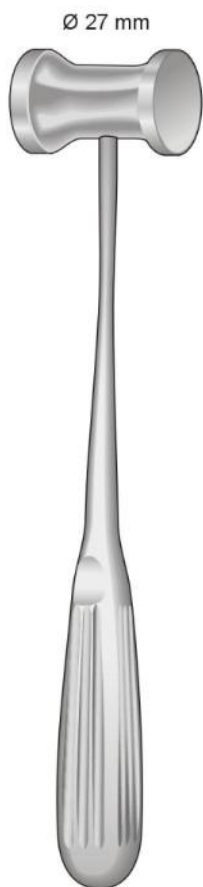

HAJEK  
SSQ-4601  
220 mm

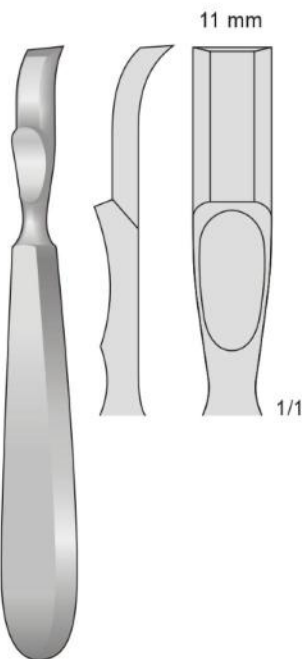

FARABEU-FOLLIN  
SSQ-4602  
160 mm

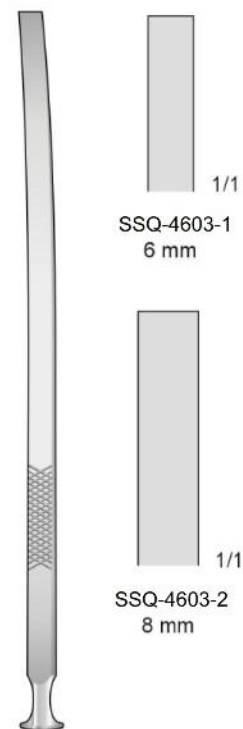

EPKER  
SSQ-4603  
180 mm

8 mm



COSCIA  
SSQ-4605  
180 mm



ALEXANDER  
SSQ-4606  
170 mm

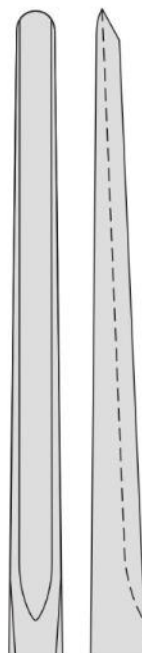

SSQ-4606-1  
5 mm

1/1

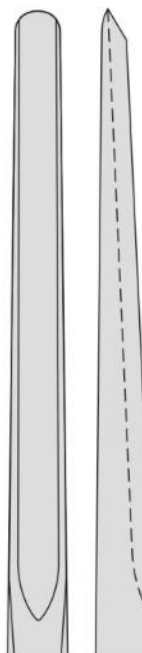

SSQ-4606-2  
7 mm

1/1

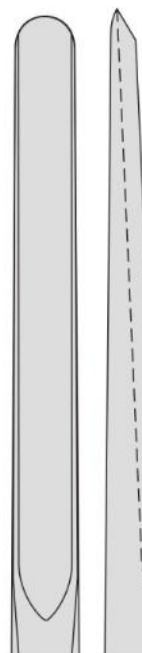

SSQ-4606-3  
9 mm

1/1

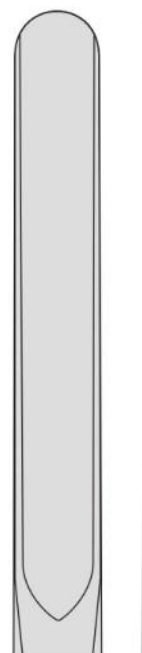

SSQ-4606-4  
11 mm

1/1



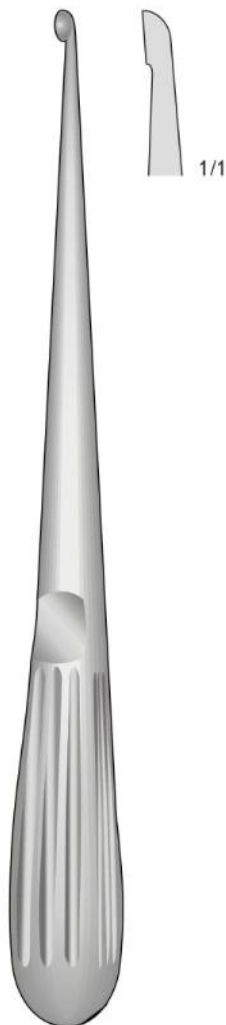

BRUNS  
SSQ-4607  
170 mm

Fig.5/0  
2,2 mm



Fig.4/0  
2,5 mm



Fig.3/0  
2,8 mm



Fig.2/0  
3,3 mm



Fig.0  
3,6 mm



Fig.1  
4,3 mm



Fig.2  
4,8 mm

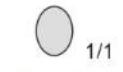

Fig.3  
5,6 mm



Fig.4  
6,0 mm



Fig.5  
6,7 mm

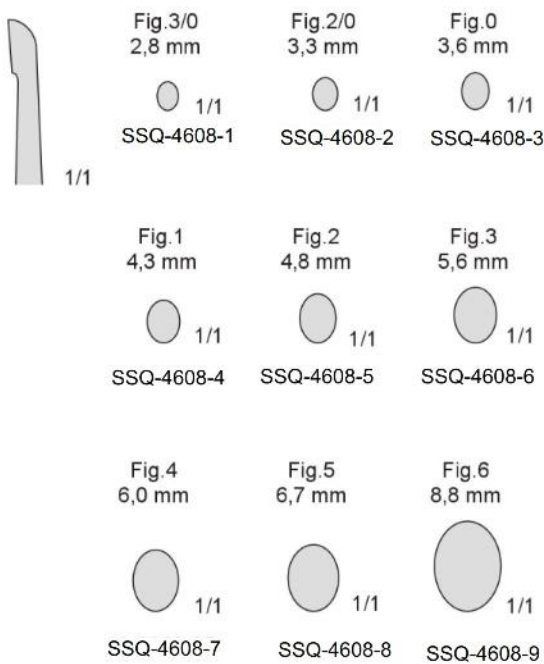

Fig.6  
8,8 mm





BRUNS  
SSQ-4608  
225 mm



BRUNS  
SSQ-4609  
225 mm

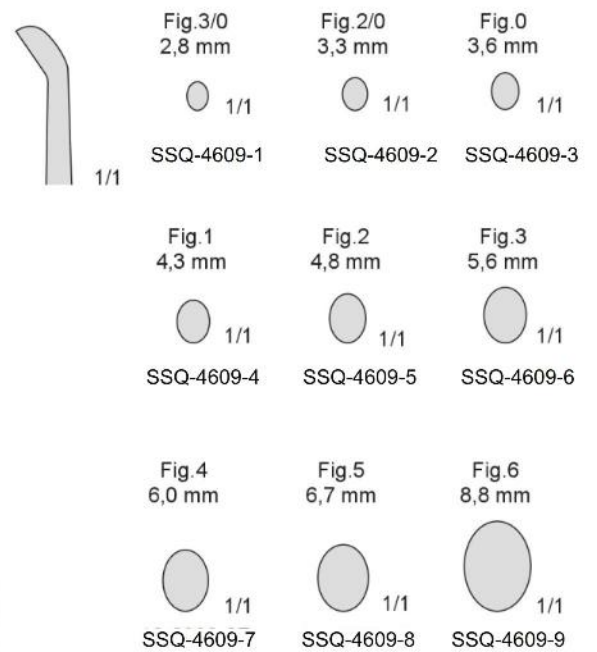

Mit Ferrozellgriff - With Ferrozell handle  
Con manico Ferrozell - Con mango de Ferrozell  
Avec poignée en Ferrozell



SYPERT  
SSQ-4610  
380 mm

SYPERT  
SSQ-4611  
380 mm

Mit Ferrozellgriff - With Ferrozell handle  
Con manico Ferrozell - Con mango de Ferrozell  
Avec poignée en Ferrozell



SYPERT  
SSQ-4612  
420 mm

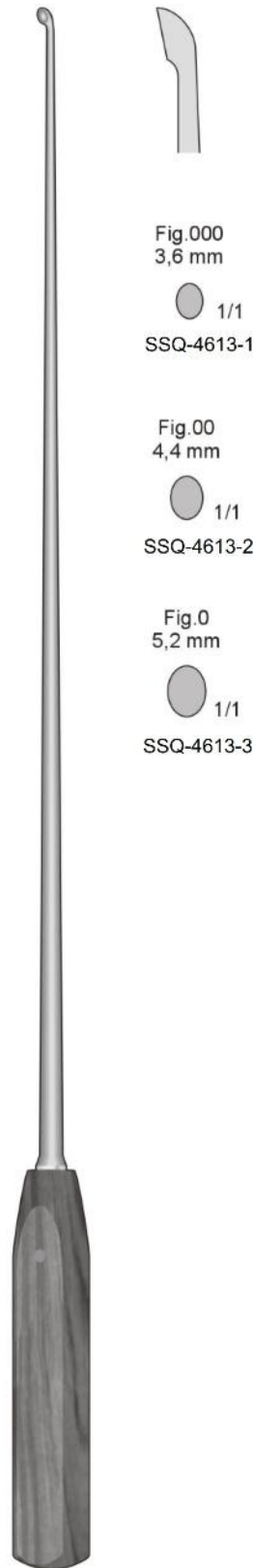

SSQ-4613  
410 mm

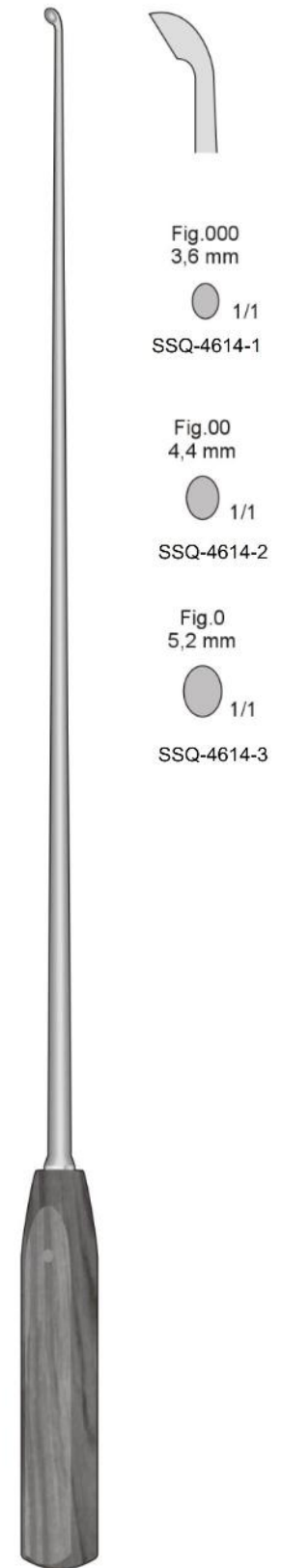

SSQ-4614  
410 mm

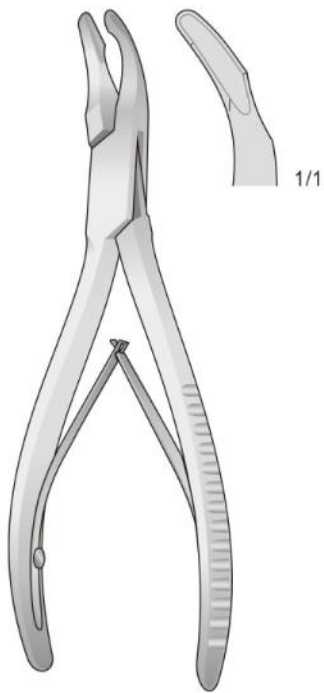

CLEVELAND  
SSQ-4617 -14140 mm  
SSQ-4617 -17170 mm

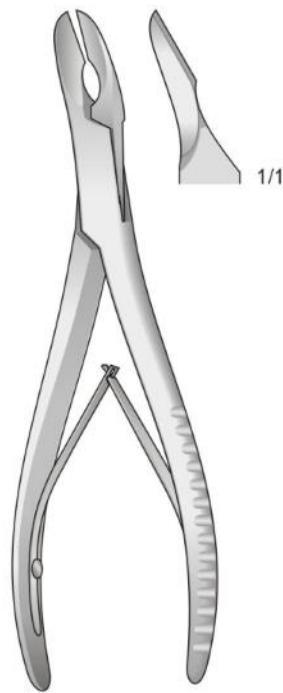

CLEVELAND  
SSQ-4618 15150 mm  
SSQ-4618 17170 mm

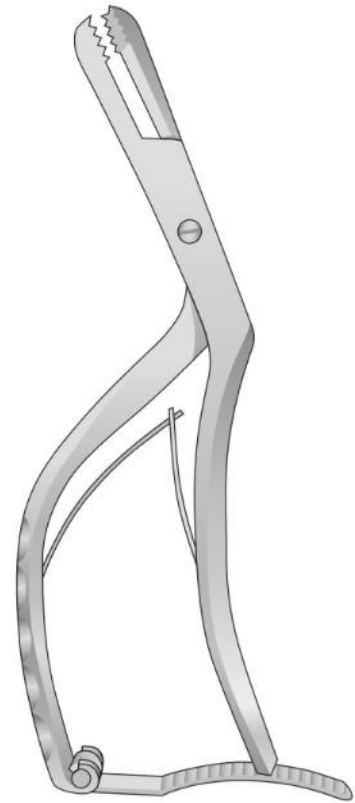

SSQ-4619  
200 mm

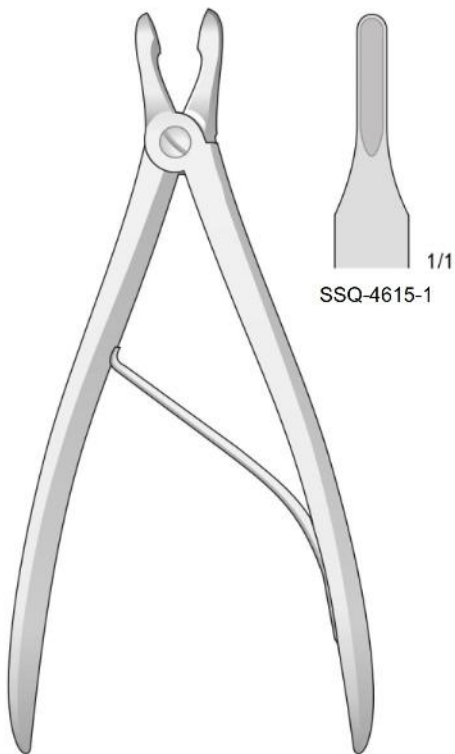

CUSHING  
SSQ-4615  
190 mm

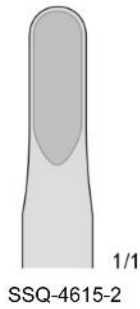

SSQ-4615-2  
1/1

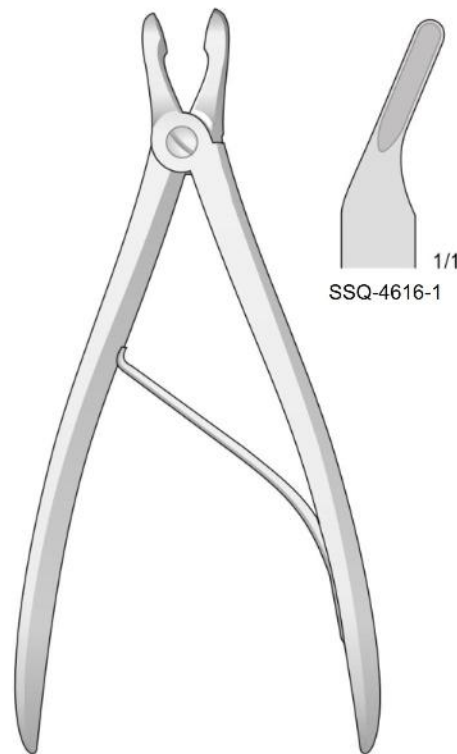

CUSHING  
SSQ-4616  
190 mm

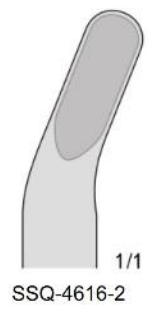

SSQ-4616-2  
1/1

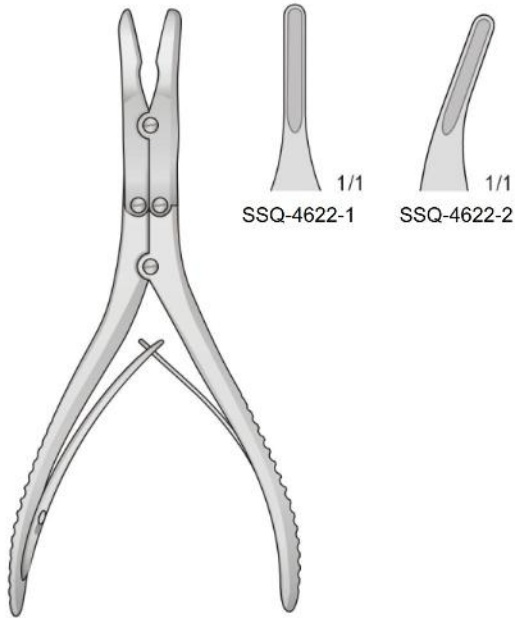

RUSKIN  
SSQ-4622  
150 mm

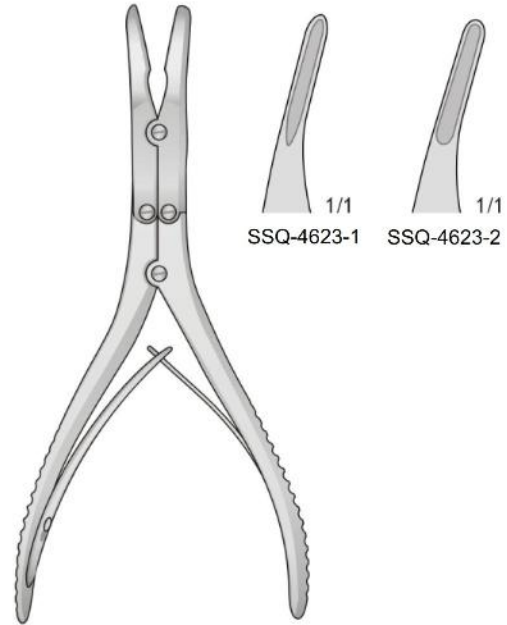

KLEINERT-KUTZ  
SSQ-4623  
155 mm

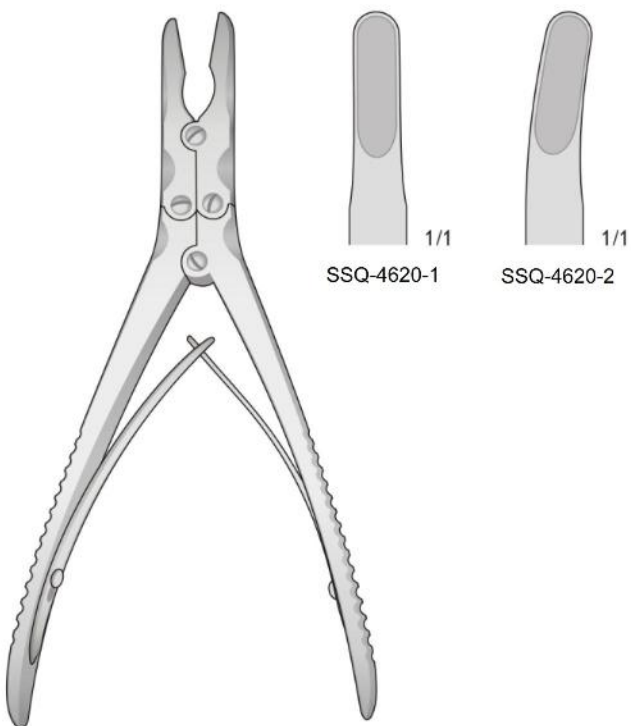

RUSKIN  
SSQ-4620  
185 mm

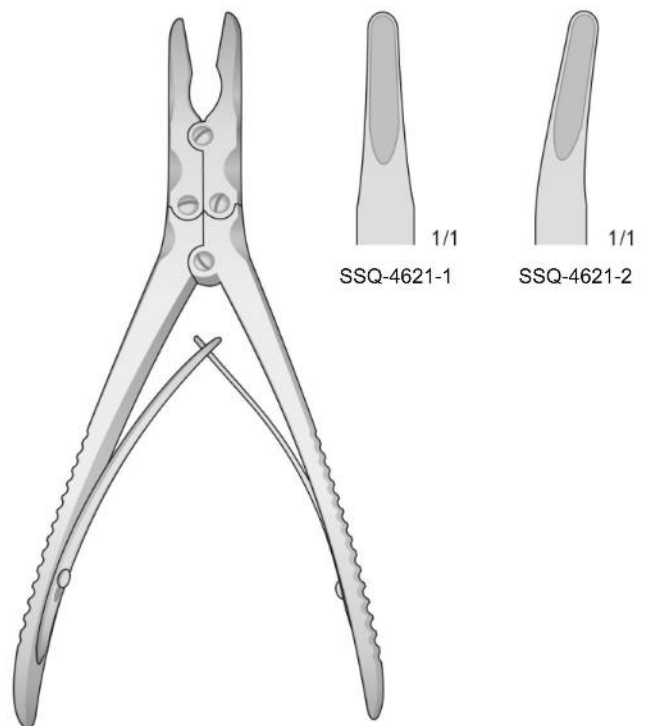

RUSKIN  
SSQ-4621  
185 mm

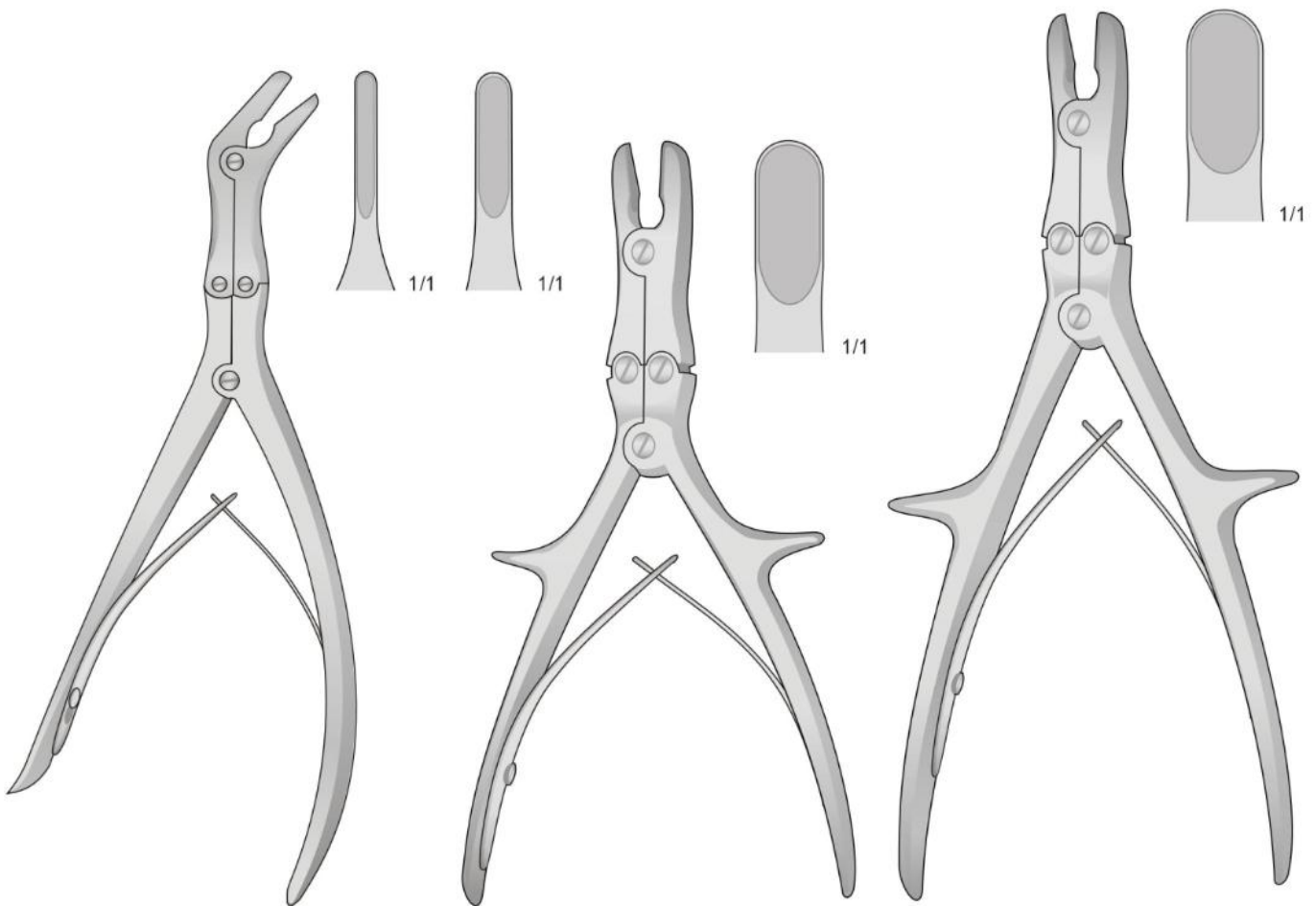

LEKSELL  
SSQ-4624  
250 mm

LUER-STILLE  
SSQ-4625  
220 mm

LUER-STILLE  
SSQ-4626  
260 mm

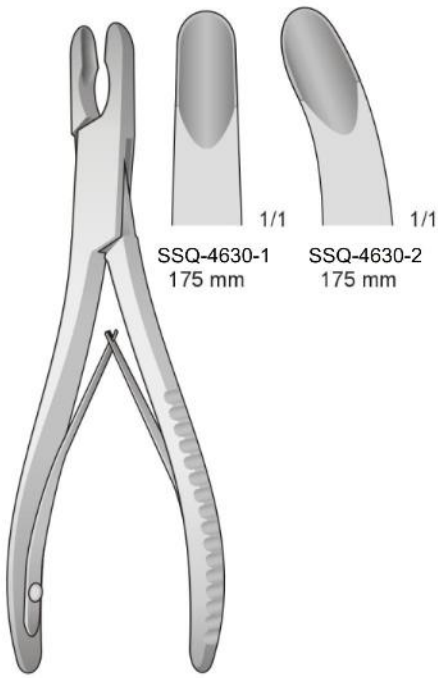

LUER  
SSQ-4630  
175 mm

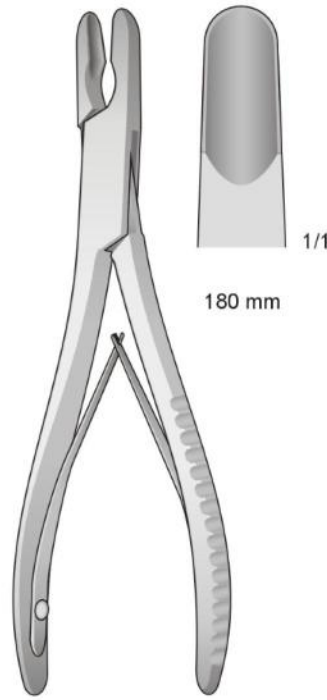

LUER  
SSQ-4631  
180 mm

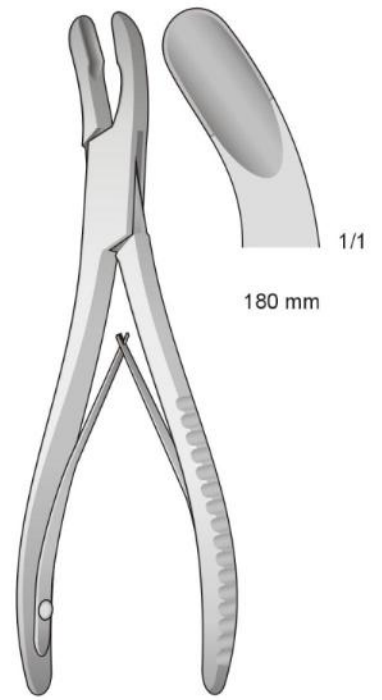

LUER  
SSQ-4632  
180 mm

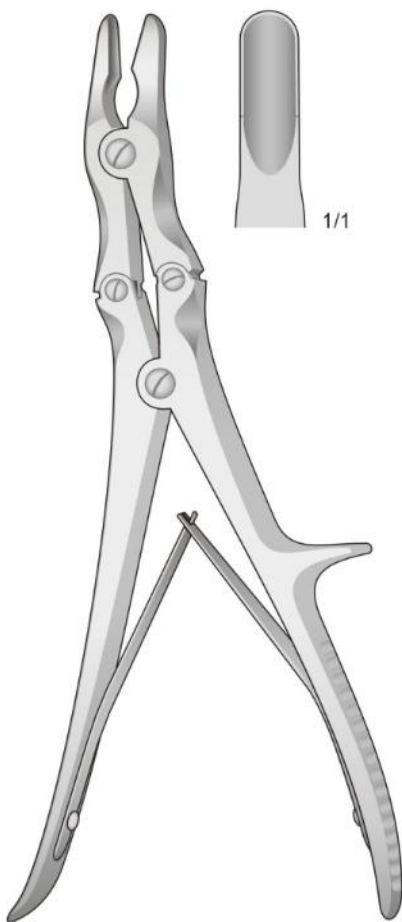

LEKSELL-STILLE  
SSQ-4627  
240 mm

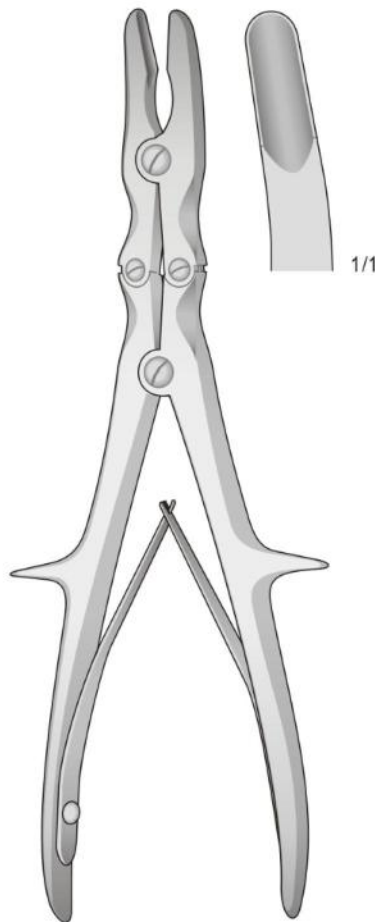

STILLE-RUSKIN  
SSQ-4628  
240 mm

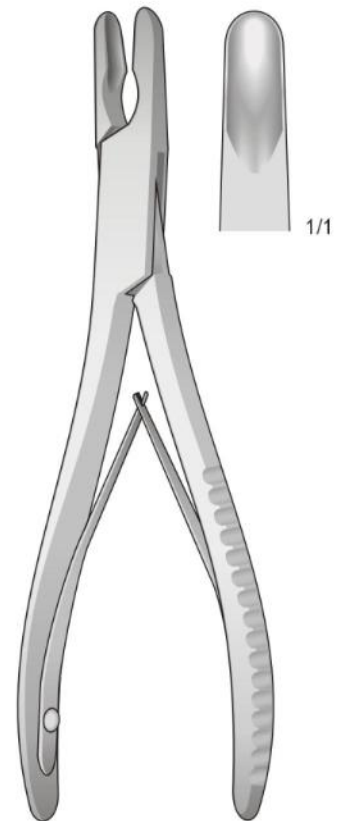

ADSON  
SSQ-4629  
210 mm



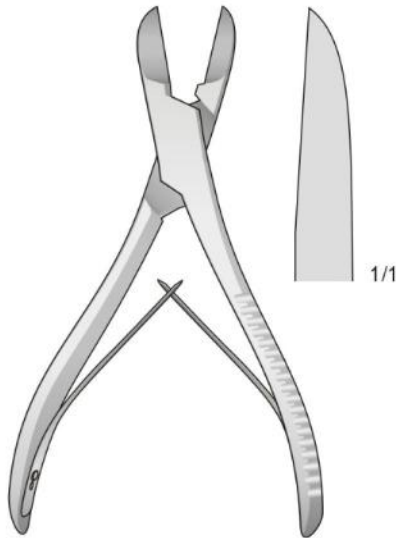

LISTON  
SSQ-4635  
140 mm

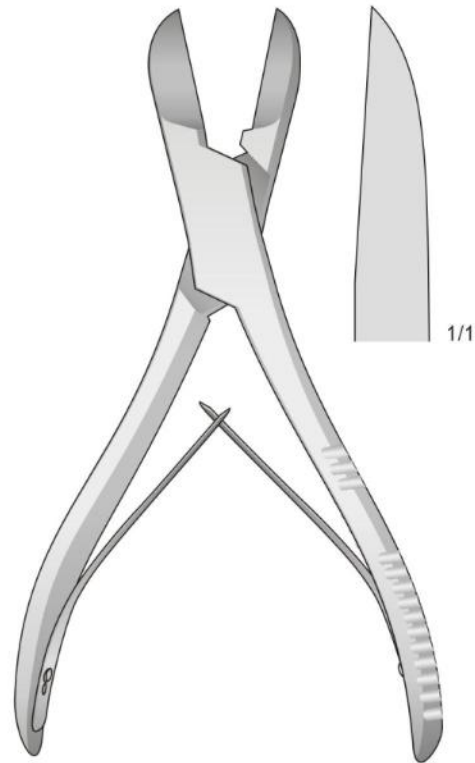

LISTON  
SSQ-4636  
200 mm

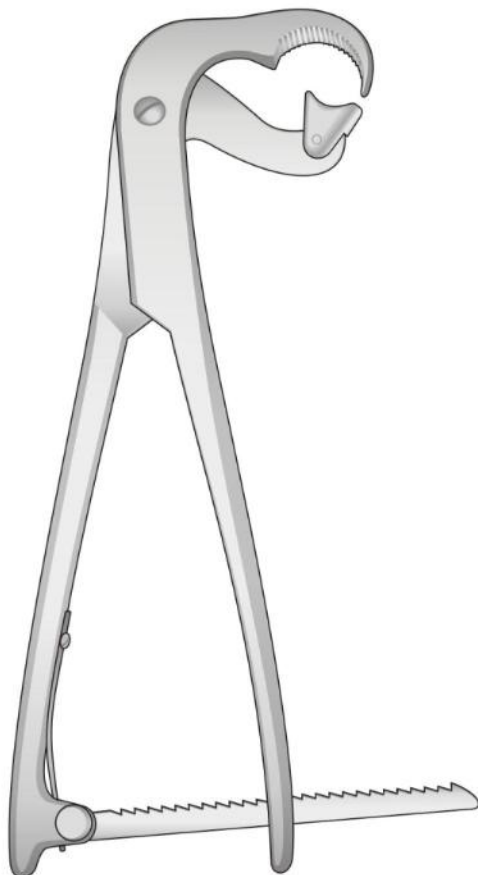

SSQ-4633  
275 mm

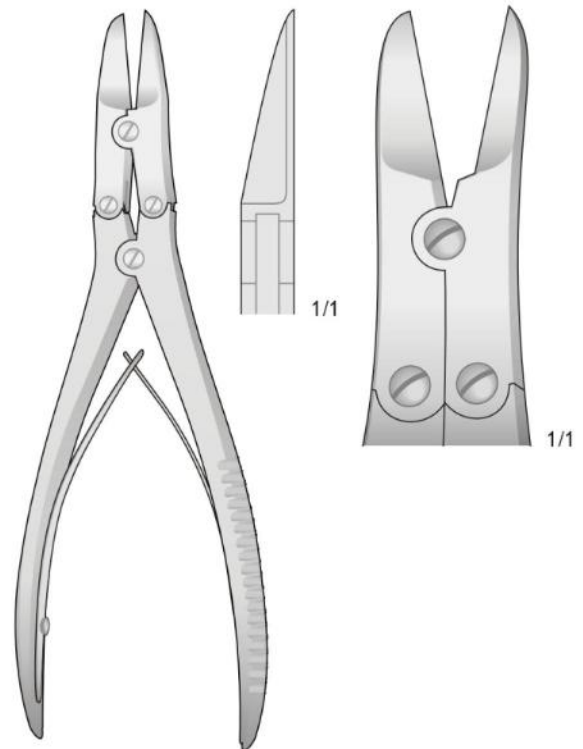

RUSKIN-LISTON  
SSQ-4634  
190 mm

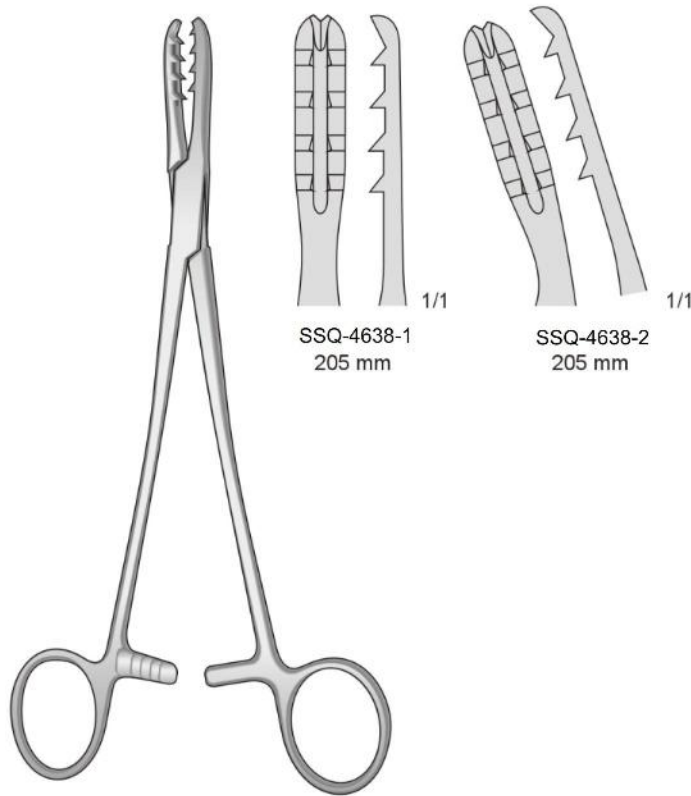

SSQ-4638-1  
205 mm

SSQ-4638-2  
205 mm

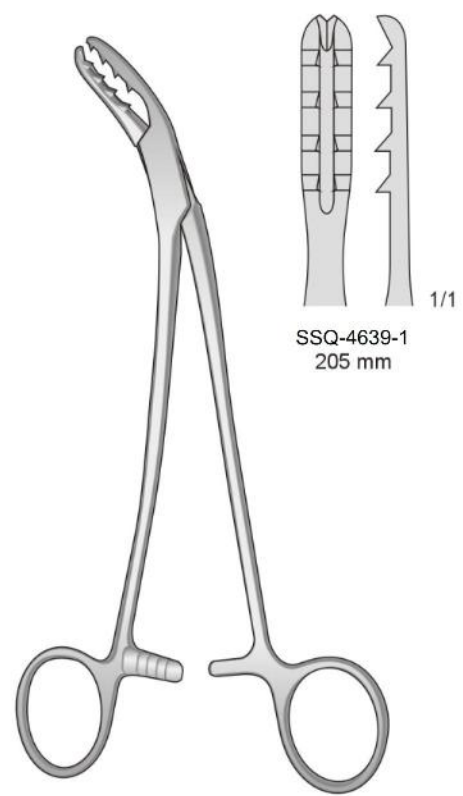

SSQ-4639-1  
205 mm

BIRCHER-GANSKE  
SSQ-4638  
205 mm

BIRCHER-GANSKE  
SSQ-4639  
200 mm

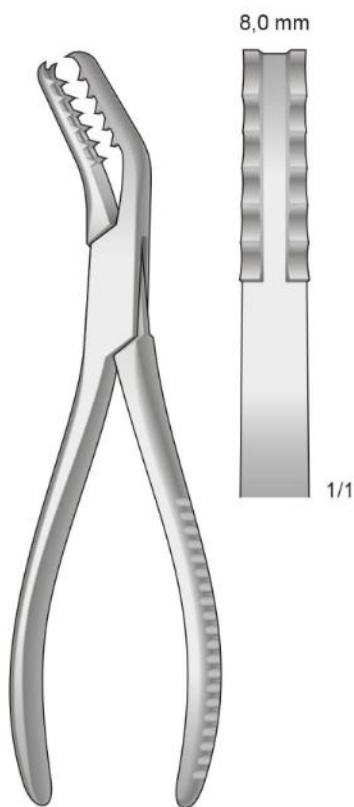

SEMB  
SSQ-4636  
190 mm

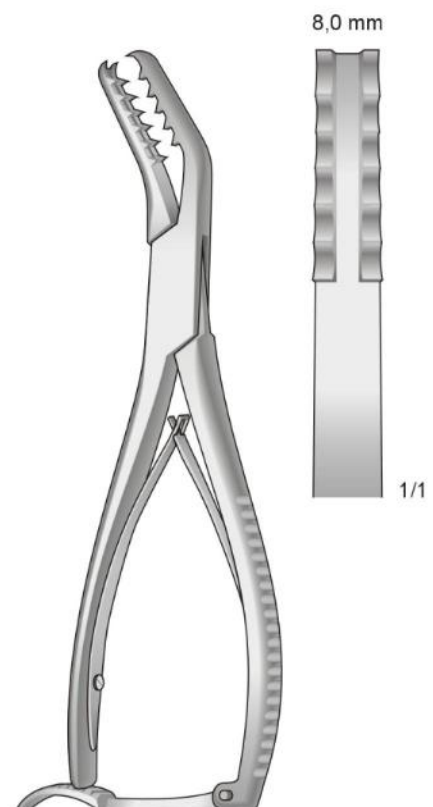

SEMB  
SSQ-4637  
190 mm

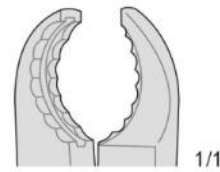
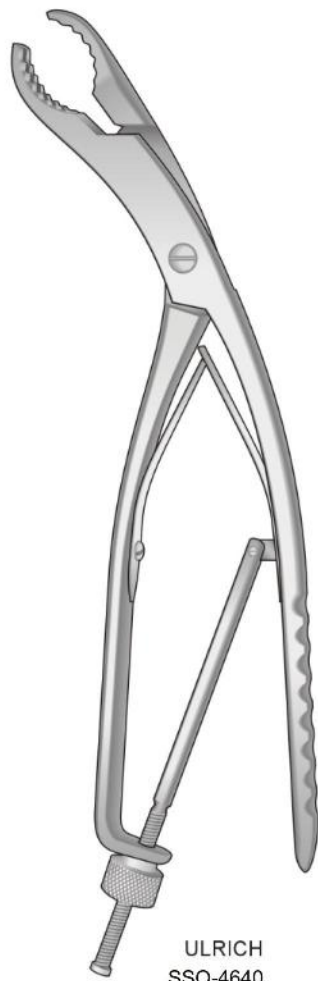
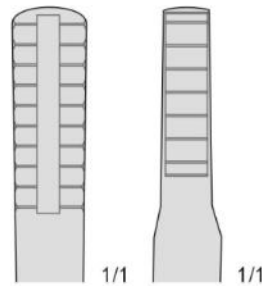
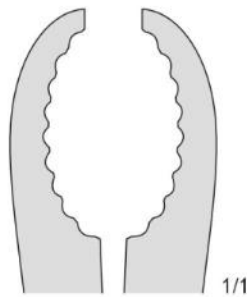

SSQ-4640-1  
220 mm

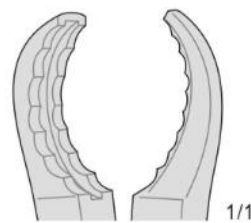

SSQ-4640-2  
240 mm

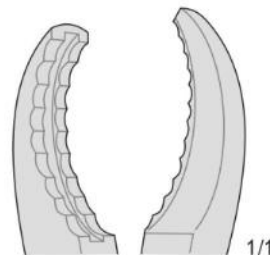

SSQ-4640-3  
270 mm

Ersatz für  
Replacement for  
Ricambio per  
Repuesto para  
SSQ-4643



Von Kirschner-Drähten Ø 6 mm  
For Kirschner wires Ø 6 mm  
Per chiodi Kirschner Ø 6 mm

Von Kirschner-Drähten Ø 6 mm  
For Kirschner wires Ø 6 mm  
Per chiodi Kirschner Ø 6 mm



SSQ-4641  
450 mm

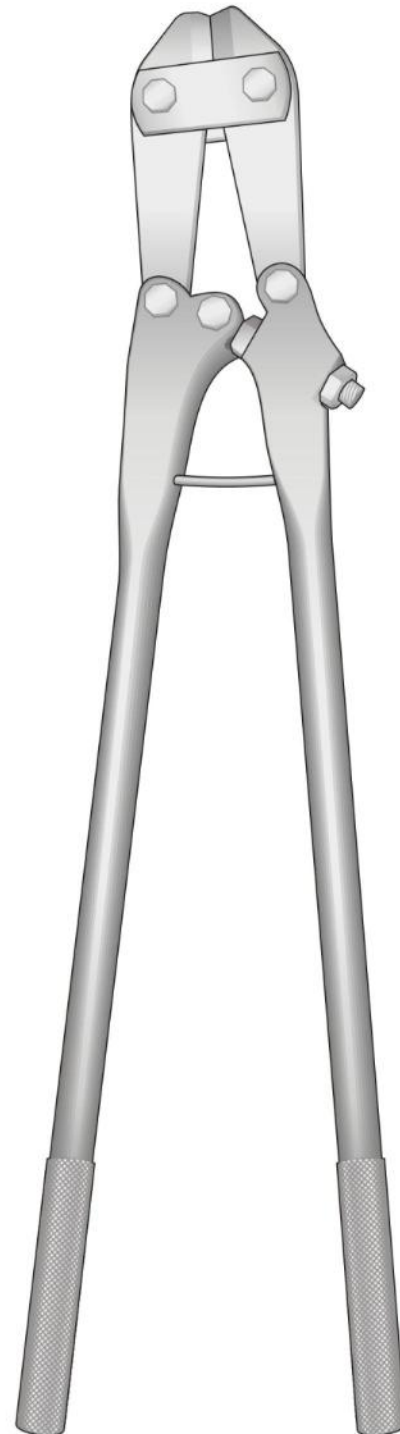

SSQ-4642  
560 mm

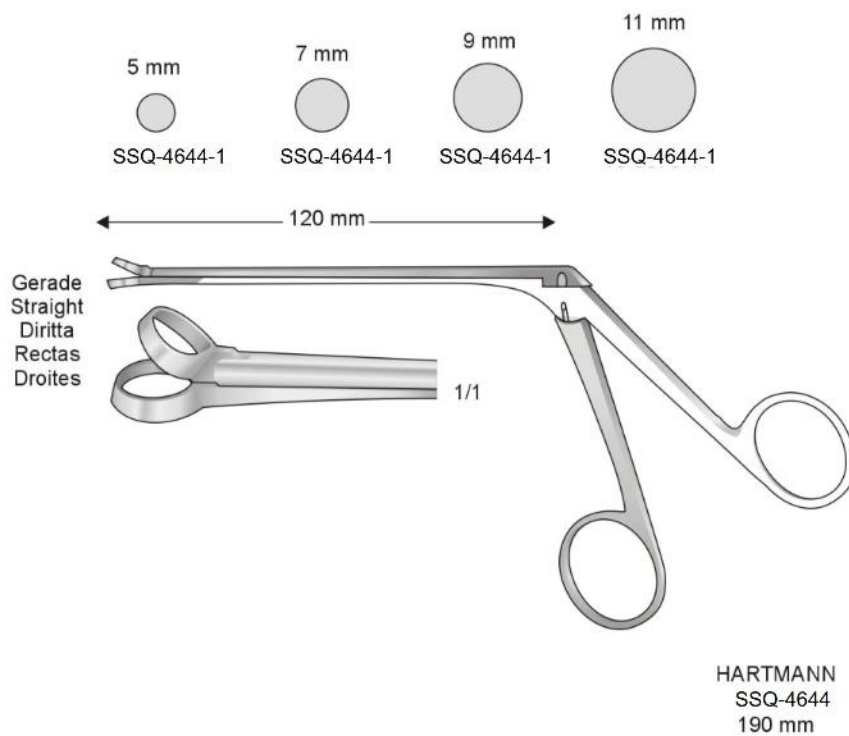
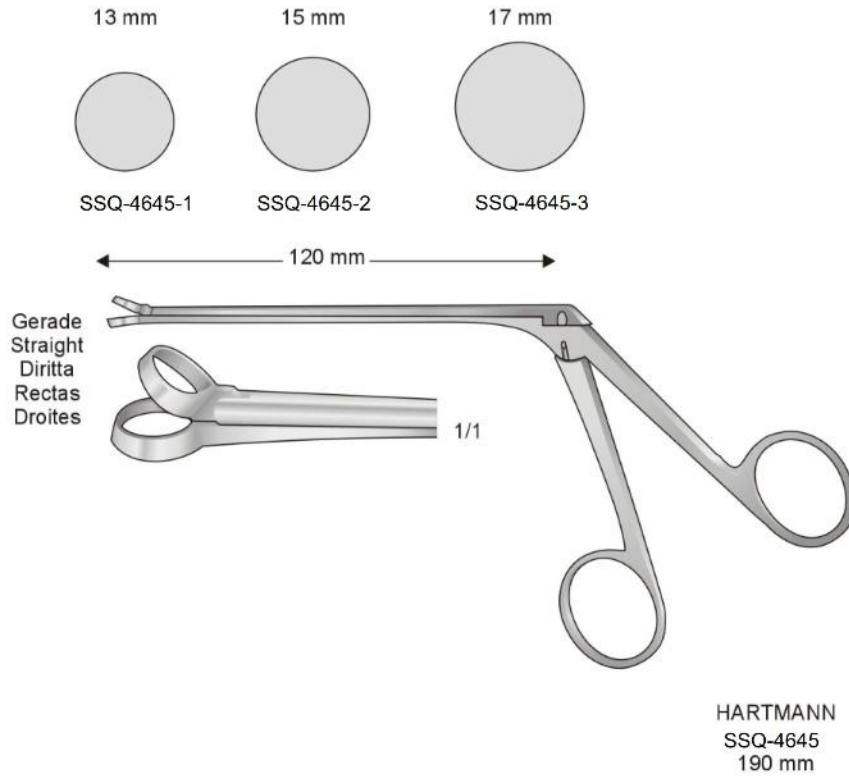

Sehnenschäler  
Tendon Stripper  
Enucleatore per tendini  
Enucleador de tendones  
Décolleurs de tendons

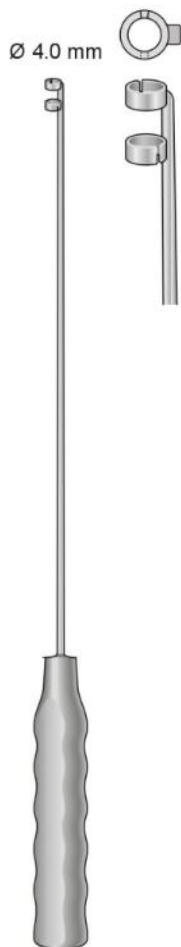

FISCHER  
SSQ-4646  
310 mm

Sehneneinflecht-klemmen - Tendon Interlacing Forceps  
Pinze per intrecciare tendini - Pinzas para entrelazar tendones  
Pincas pour entrelacer les tendons

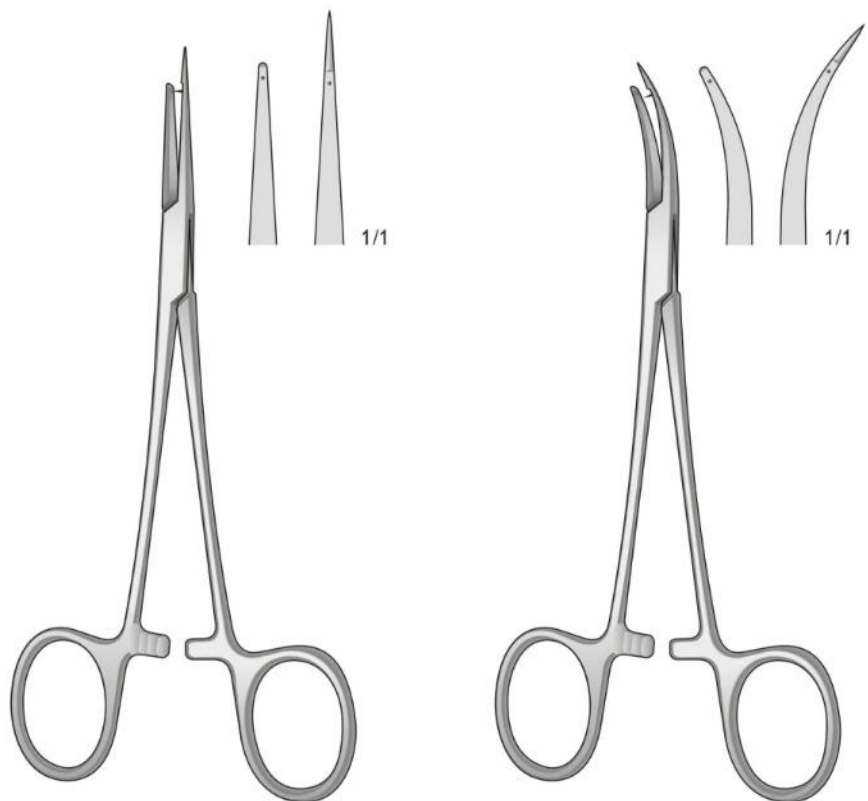

SSQ-4647  
150 mm

SSQ-4648  
150 mm

**Rohrschaft. Mikro-Faßzängchen - Micro ear forceps with tubular shaft**

Mikro-Löffelzängchen Micro cup shaped forceps Micro pinze a cucchiaino		Mikro-Scheren Micro scissors Micro forbici	
0,9 x 1,0 mm ○ Oval Ovale Ovales		SSQ-4649-1 Gerade - Straight Diritta - Recta Droit	 BELLUCCI SSQ-4649-8 Gerade Straight Diritta Recta Droit
0,9 x 1,0 mm ○ Oval Ovale Ovales		SSQ-4649-2 Nach Oben Gebogen Curved up Curva in alto	 BELLUCCI SSQ-4649-9 Nach Oben Gebogen Curved up Curva in alto
0,8 x 1,3 mm ○ Oval Ovale Ovales		WULLSTEIN SSQ-4649-3 Gerade - Straight Diritta - Recta Droit	 BELLUCCI SSQ-4649-10 Links Gebogen Curved to left Curva a sinistra Curvas a la izquierda Courbes à gauche
0,8 x 1,3 mm ○ Oval Ovale Ovales		WULLSTEIN SSQ-4649-4 Links Gebogen - Curved to left Curva a sinistra - Curvas a la izquierda Courbes à gauche	 BELLUCCI SSQ-4649-11 Rechts Gebogen Curved to right Curva a destra Curvas a la derecha Courbes à droite
0,8 x 1,3 mm ○ Oval Ovale Ovales		WULLSTEIN SSQ-4649-5 Rechts Gebogen - Curved to right Curva a destra - Curvas a la derecha Courbes à droite	 BELLUCCI SSQ-4649-12 Orizzontale
1,0 mm ○ Rund Round Tonda		WULLSTEIN SSQ-4649-6 Gerade - Straight Diritta - Recta Droit	
1,7 x 2,5 mm ○ Oval Ovale Ovales		WULLSTEIN SSQ-4649-7 Gerade - Straight Diritta - Recta Droit	

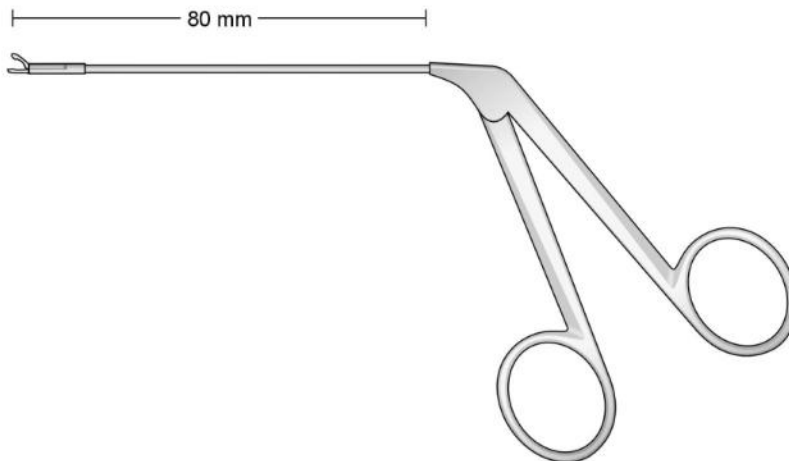

SSQ-4649  
80 mm

0,6 x 0,5 mm



SSQ-4650-1  
Gerade  
Straight  
Diritta  
Recta  
Droit

0,9 x 1,1 mm



SSQ-4650-5  
Gerade  
Straight  
Diritta  
Recta  
Droit

0,6 x 0,5 mm



SSQ-4650-2  
Links Gebogen  
Curved to left  
Curva a sinistra  
Curvas a la izquierda  
Courbes à gauche

0,9 x 1,1 mm



SSQ-4650-6  
Links Gebogen  
Curved to left  
Curva a sinistra  
Curvas a la izquierda  
Courbes à gauche

0,6 x 0,5 mm



SSQ-4650-3  
Rechts Gebogen  
Curved to right  
Curva a destra  
Curvas a la derecha  
Courbes à droite

0,9 x 1,1 mm



SSQ-4650-7  
Rechts Gebogen  
Curved to right  
Curva a destra  
Curvas a la derecha  
Courbes à droite

0,6 x 0,5 mm



SSQ-4650-4  
Nach Oben Gebogen  
Curved up  
Curva in alto

0,9 x 1,1 mm



SSQ-4650-8  
Nach Oben Gebogen  
Curved up  
Curva in alto

0,9 x 1,1 mm



SSQ-4650-9  
Nach Unten Gebogen  
Curved down  
Curva in basso

Schaft zerlegbar  
Dismantable shaft  
Asta smontabile  
Vástago desmontable  
Tige démontable

80 mm

Superfein  
Extremely delicate  
Modello super fine  
Superfina  
Modèle superfin

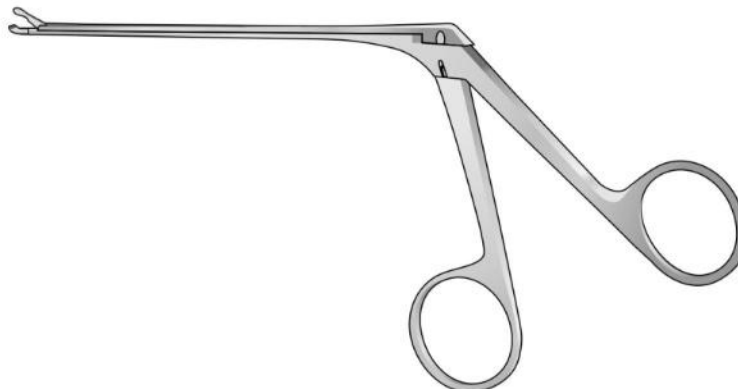

SSQ-4650  
80 mm



6,0 x 0,8 mm



SCHUKNECHT  
SSQ-4651-1  
Gerade  
Straight  
Diritta  
Recta  
Droit

4,0 x 0,5 mm



SSQ-4651-5  
Rechts Gebogen  
Curved to right  
Curva a destra  
Curvas a la derecha  
Courbes à droite

5,0 x 0,8 mm



GREVEN  
SSQ-4651-2  
Gerade  
Straight  
Diritta  
Recta  
Droit

4,0 x 0,5 mm



SSQ-4651-6  
Links Gebogen  
Curved to left  
Curva a sinistra  
Curvas a la izquierda  
Courbes à gauche

4,0 x 0,5 mm

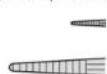

SSQ-4651-3  
Gerade  
Straight  
Diritta  
Recta  
Droit

4,0 x 0,5 mm



SSQ-4651-7  
Nach Oben Gebogen  
Curved up  
Curva in alto

4,0 x 0,5 mm

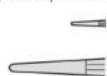

SSQ-4651-4  
Glattes Maul  
Smooth jaws  
Morso liscio  
Mandibula lisa  
Mors lisses

4,0 x 0,5 mm

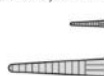

SSQ-4651-8  
Nach Unten Gebogen  
Curved down  
Curva in basso

Schaft zerlegbar  
Dismantable shaft  
Asta smontabile  
Vástago desmontable  
Tige démontable

Superfein  
Extremely delicate  
Modello super fine  
Superfina  
Modèle superfin

80 mm

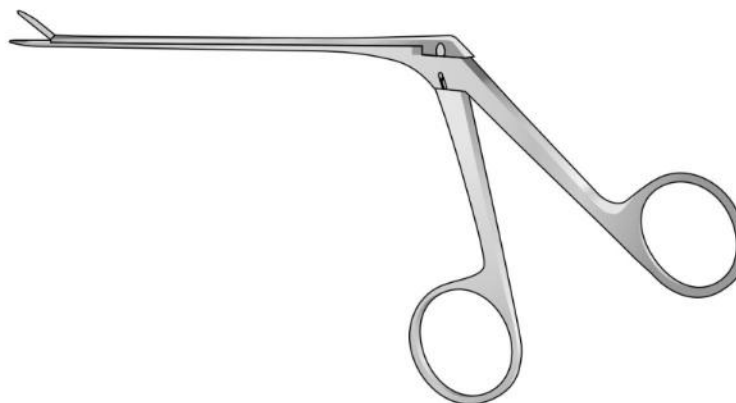

SSQ-4651  
80 mm

**Rohrschaft. Mikro-Faßzängchen**  
**Micro ear forceps with tubular shaft**

0,8 x 3,5 mm



0,8 x 3,5 mm

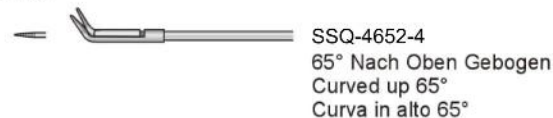

1,0 x 5,0 mm

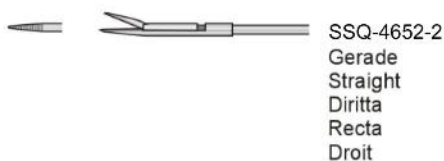

0,8 x 3,5 mm

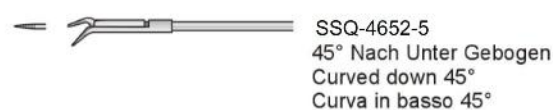

1,5 x 6,0 mm

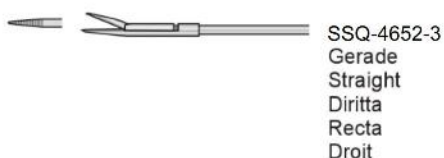

1,0 x 5,0 mm

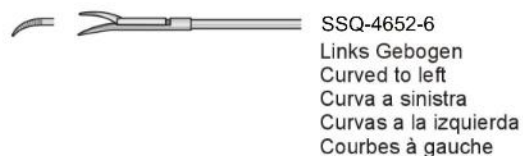

1,0 x 5,0 mm

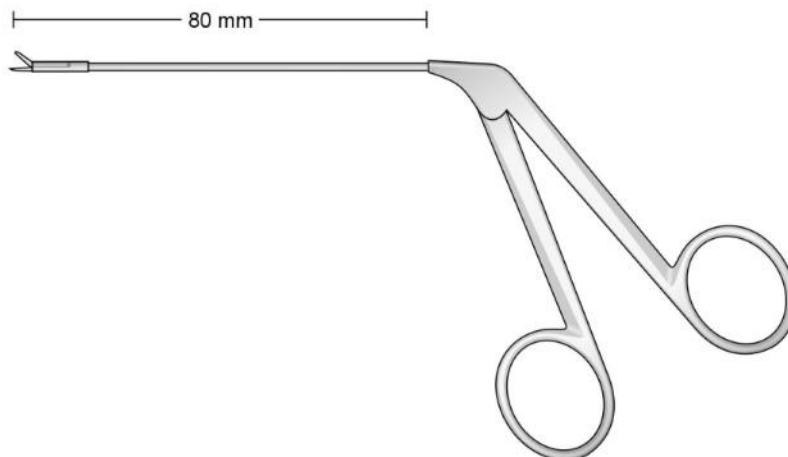
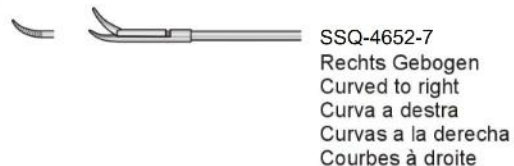

SSQ-4652  
80 mm



SSQ-4653-1  
Gerade  
Straight  
Rette  
Rectas  
Droits



SSQ-4653-2  
Gerade, horizontal schneidend  
Straight, horizontally cutting  
Rette, taglio orizzontale  
Rectas, de corte horizontal  
Droits, à coupe horizontale



SSQ-4653-3  
Nach links gebogen  
Curved to left  
Curve a sinistra  
Acodadas hacia la izquierda  
Courbes à gauche



SSQ-4653-4  
Nach rechts gebogen  
Curved to right  
Curve a destra  
Acodadas hacia la derecha  
Courbes à droite



SSQ-4653-5  
Nach oben abgewinkelt  
Angled up  
Angolate in alto  
Angulada hacia arriba  
Coudés vers le haut



SSQ-4653-6  
Nach unten abgewinkelt  
Angled down  
Angolate in basso  
Angulada hacia abajo  
Coudés vers le bas



SSQ-4653-7  
Gerefties maul, gerade  
Serrated jaws, straight  
Morsi zigrinati, retti  
Boca estriada, recta  
Mors striés, droits



SSQ-4653-8  
Gerefties maul, rechts gebogen  
Serrated jaws, right  
Morsi zigrinati, curvi a destra  
Boca estriada, curva a la derecha  
Mors striés, courbes à droite



SSQ-4653-9  
Gerefties maul, links gebogen  
Serrated jaws, left  
Morsi zigrinati, curvi a sinistra  
Boca estriada, curva a la izquierda  
Mors striés, courbes à gauche

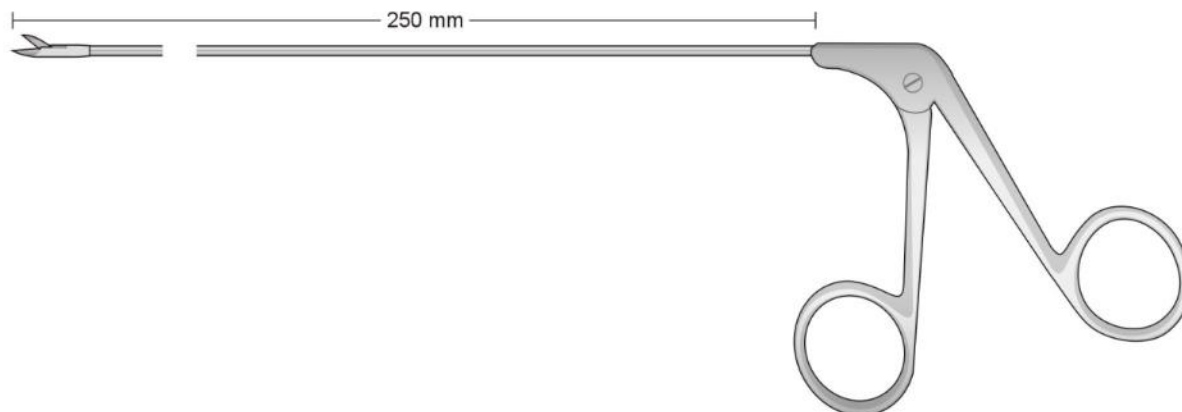

SSQ-4653  
250 mm



SSQ-4654-1  
Rundes Löffelmaul, gerade  
Round cup jaws, straight  
Morso a forma di cucchiaio rotondo, retto  
Boca redonda en forma de cucharilla, recta  
Mors ronds en cuiller, droits



SSQ-4654-2  
Rundes Löffelmaul, nach oben  
Round cup jaws, up  
Morso a forma di cucchiaio rotondo, in alto  
Boca redonda en forma de cucharilla, arriba  
Mors ronds en cuiller, courbes en haut



SSQ-4654-3  
Rundes Löffelmaul, rechts  
Round cup jaws, right  
Morso a forma di cucchiaio rotondo, destra  
Boca redonda en forma de cucharilla, a la derecha  
Mors ronds en cuiller, courbes à droite



SSQ-4654-4  
Rundes Löffelmaul, links  
Round cup jaws, left  
Morso a forma di cucchiaio rotondo, sinistra  
Boca redonda en forma de cucharilla, a la izquierda  
Mors ronds en cuiller, courbes à gauche



SSQ-4654-5  
Ovales Löffelmaul, gerade  
Oval cup jaws, straight  
Morso a forma di cucchiaio ovale, retto  
Boca ovalada en forma de cucharilla, recta  
Mors ovales en cuiller, droits



SSQ-4654-6  
Ovales Löffelmaul, nach oben  
Oval cup jaws, up  
Morso a forma di cucchiaio ovale, in alto  
Boca ovalada en forma de cucharilla, arriba  
Mors ovales en cuiller, courbes en haut



SSQ-4654-7  
Ovales Löffelmaul, rechts  
Oval cup jaws, right  
Morso a forma di cucchiaio ovale, destra  
Boca ovalada en forma de cucharilla, a la derecha  
Mors ovales en cuiller, courbes à droite



SSQ-4654-8  
Ovales Löffelmaul, links  
Oval cup jaws, left  
Morso a forma di cucchiaio ovale, sinistra  
Boca ovalada en forma de cucharilla, a la izquierda  
Mors ovales en cuiller, courbes à gauche



SSQ-4654-9  
Ovales Löffelmaul, gerade  
Oval cup jaws, straight  
Morso a forma di cucchiaio ovale, retto  
Boca ovalada en forma de cucharilla, recta  
Mors ovales en cuiller, droits



SSQ-4654-10  
Maulteile gefenstert  
Jaw fenestrated  
Morso fenestrato  
Boca fenestrada  
Mors ajourés

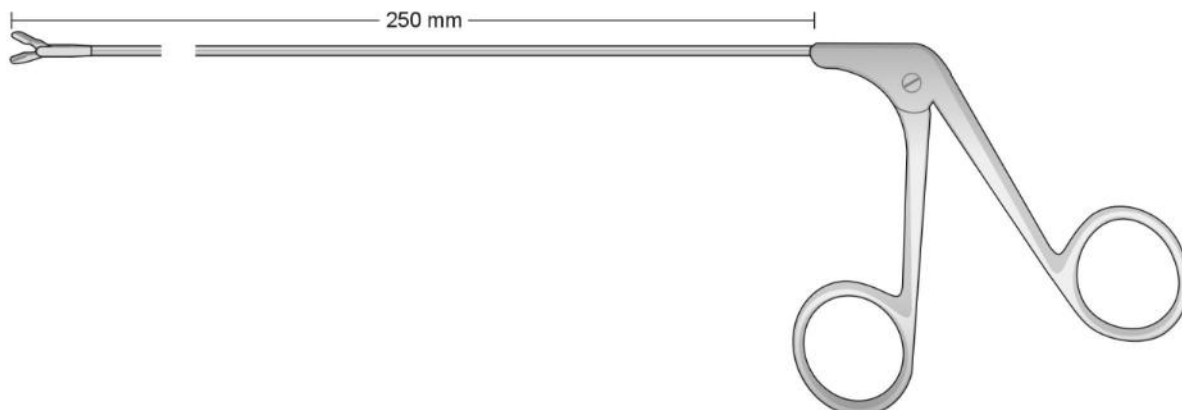

SSQ-4654  
250 mm

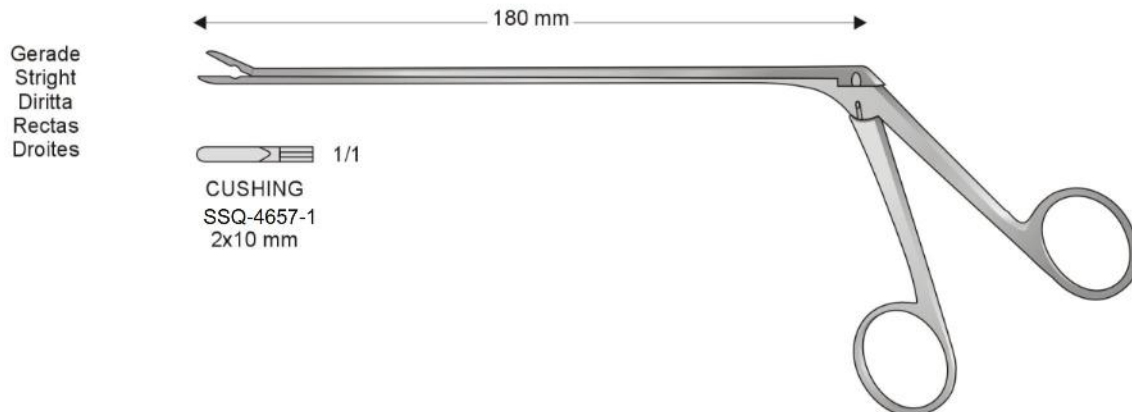

CUSHING  
SSQ-4657

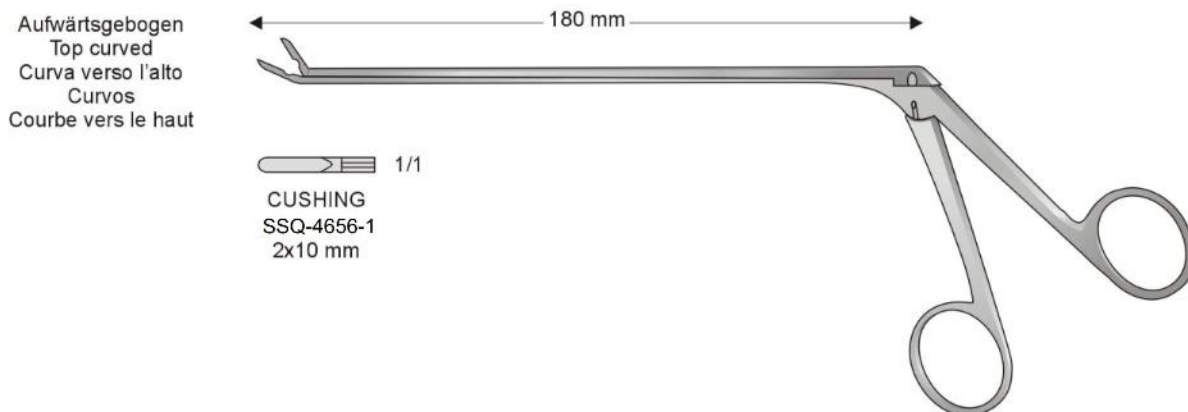

CUSHING  
SSQ-4656

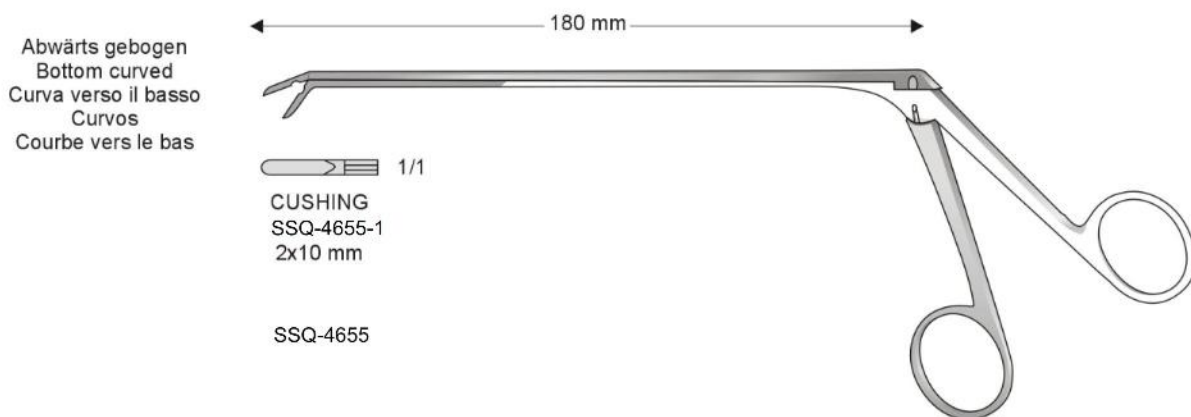

CUSHING  
SSQ-4655

Katheter-Einführungsinstrumente  
Catheter introducing instruments  
Strumenti per tendere ed introdurre i cateteri  
Instrumentos para introducir catéteres  
Mandrin pour introduire les sondes

Ø 1,2 mm

Endospekula für Harnröhre und  
Cervix, ohne Sperre  
Endospecula for cervix and urethra,  
without ratchet

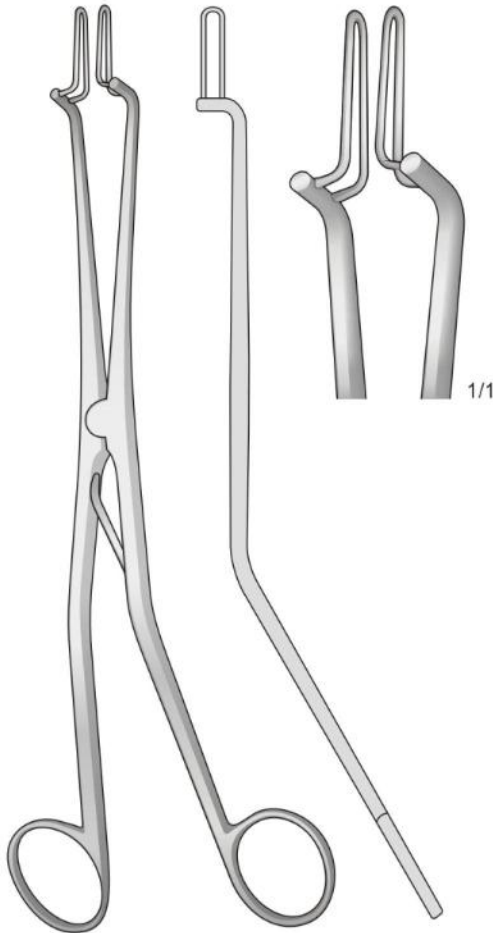

KOGAN  
SSQ-4658  
240 mm

Endospekula für Harnröhre und  
Cervix, mit Skalensperre und Fixierschraube  
Endospecula for cervix and urethra,  
with scale-ratchet and fixing screws  
Con cremagliera a scala e vite di fissaggio  
Con cremallera graduada y tornillo de fijación  
Avec crémaillère à échelle et vis à fixation

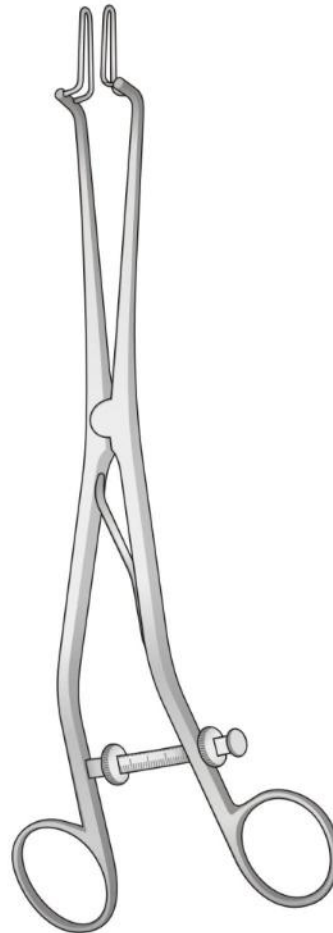

KOGAN  
SSQ-4659  
240 mm

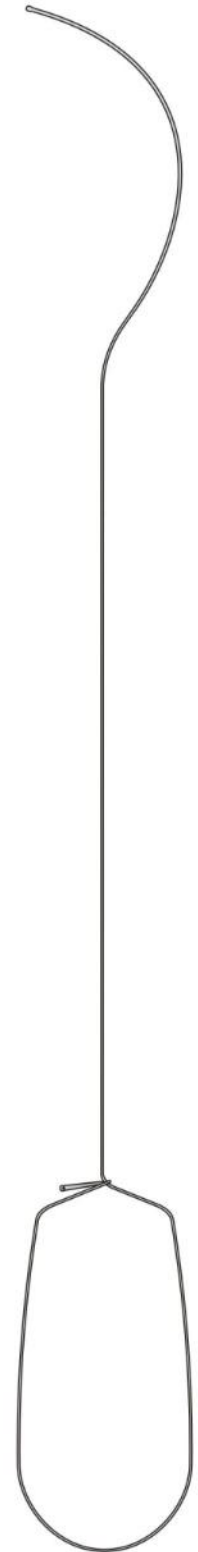

SSQ-4660  
425 mm

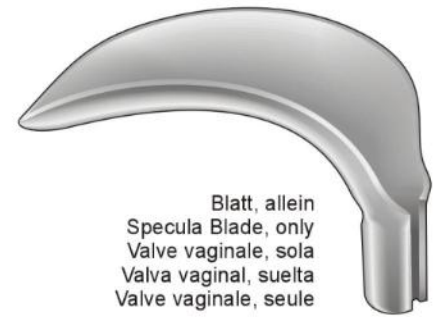
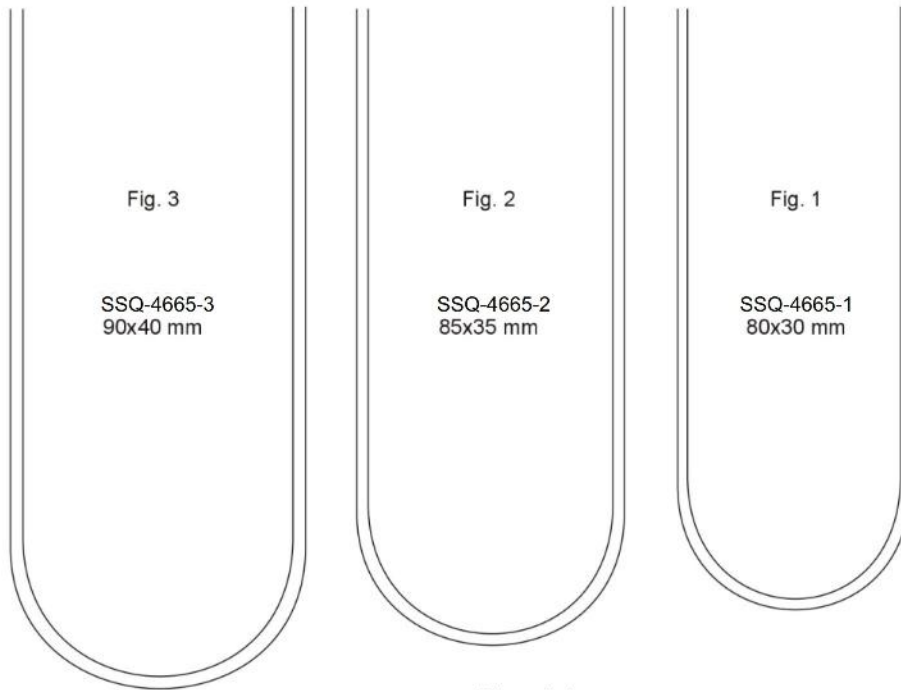

Blatt, allein  
Specula Blade, only  
Valve vaginale, sola  
Valva vaginal, suelta  
Valve vaginale, seule

SCHERBAK  
SSQ-4665

Blasenhalsperrer  
Sounds Bladder  
Dilatatore del collo vescicale  
Sonda vesicales  
Dilatateur pour le col vésical

Biopsiekürette  
Uterine Biopsy Curette  
Curette per biopsia  
Curetts para biopsia  
Curettes pour biopsie

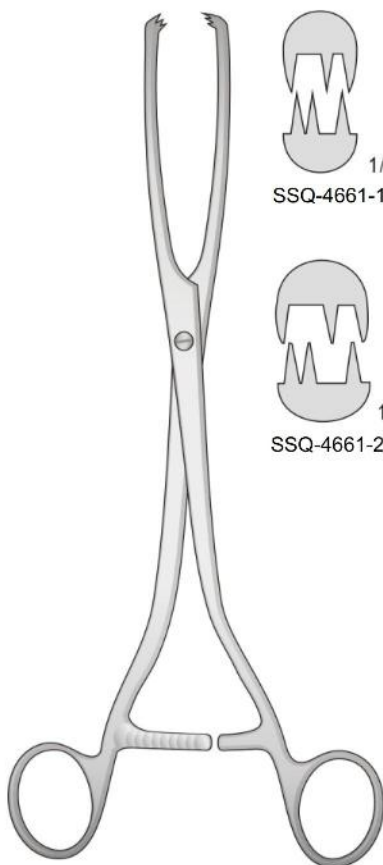

MUSEUX  
SSQ-4661  
265 mm

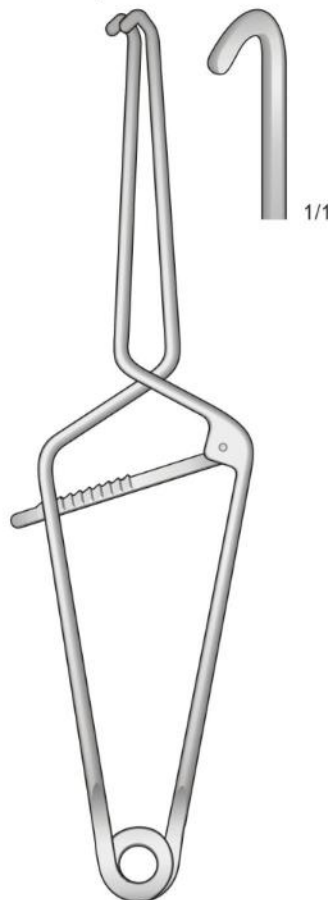

MILLIN  
SSQ-4662  
280 mm

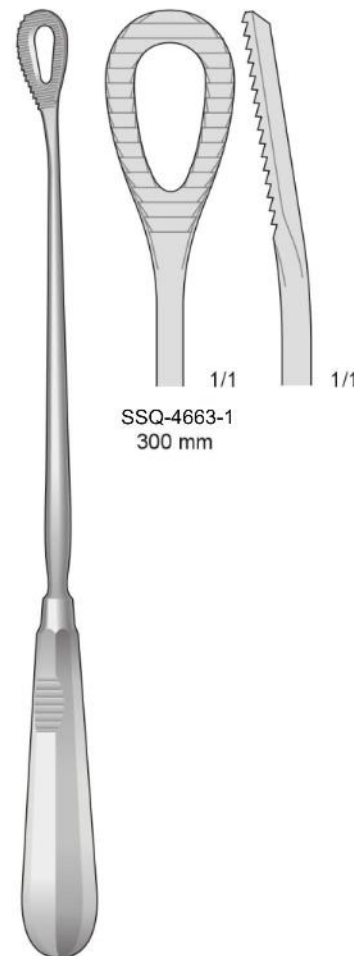

PESTALOZZA  
SSQ-4663  
300 mm

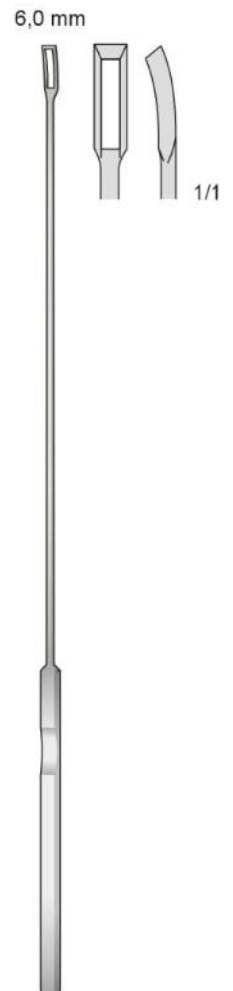

KEVORKIAN  
SSQ-4664  
300 mm

Gewicht zum Vaginalsepekulum  
Weight for Vaginal Speculum  
Peso per specolo vaginale  
Peso para espéculo vaginal  
Poids pour spéculum vaginal



SCHERBAK  
SSQ-4670-110,5 mm 400 gr  
SSQ-4670-2 13 mm 800 gr

Blatt, allein  
Specula Blade, only  
Valve vaginale, sola  
Valva vaginal, suelta  
Valve vaginale, seule



SCHERBAK  
SSQ-4669

Griff zum Vaginalsepekulum  
Handle for Vaginal Speculum  
Manico per specolo vaginale  
Mango para espéculo vaginal  
Manche pour spéculum vaginal

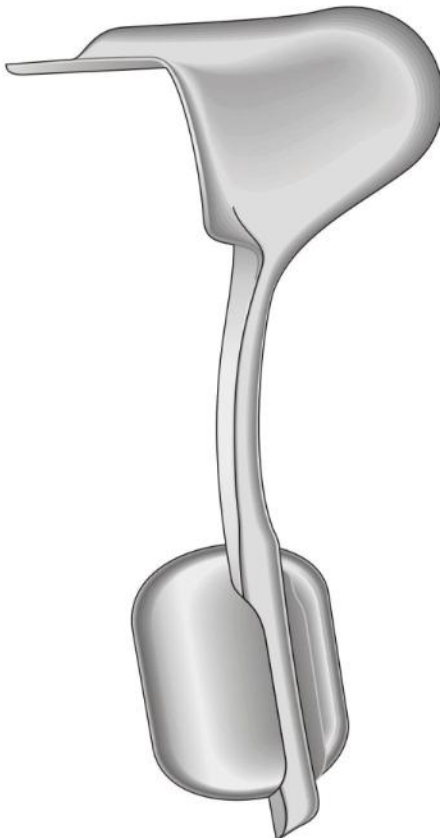

AUVARD  
SSQ-4666  
230 mm

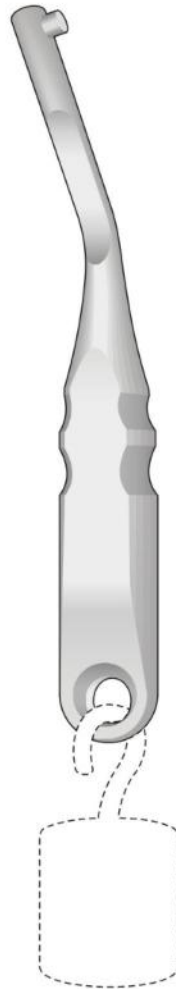

SCHERBAK  
SSQ-4667  
200 mm

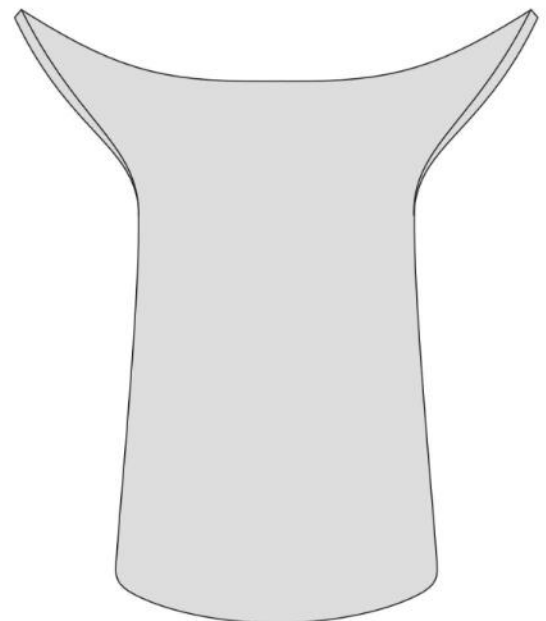

SSQ-4668-1  
81x45 - 70 mm

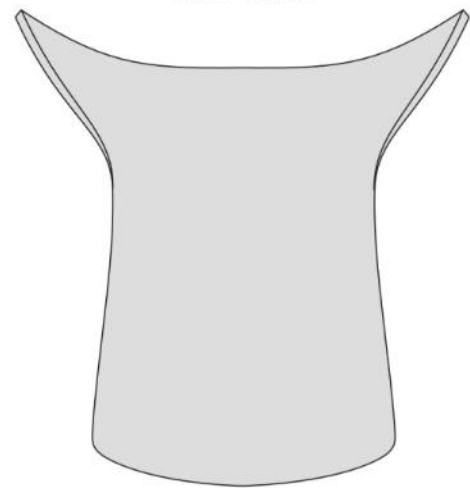

SSQ-4668  
62x40 - 60 mm



Geschwärzt  
Surface Black-finish  
Superficie anti-riflesso  
Surface noircie



SSQ-4673  
75 x 20 mm



SSQ-4671  
100 x 22 mm



SSQ-4672  
120 x 25 mm

SSQ-4680

Komplettsset mit 14 Uterusdilatoren ohne metalletui  
Set con 14 dilatatori uterini senza scatola

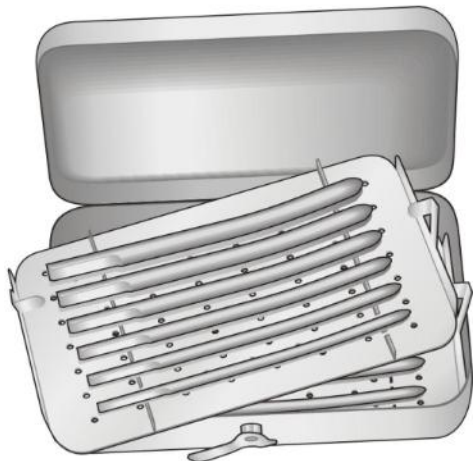

SSQ-4681

Komplettsset mit 26 Uterusdilatoren ohne metalletui  
Set con 26 dilatatori uterini senza scatola

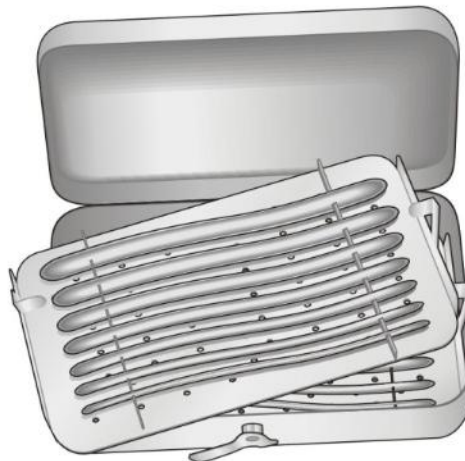

SSQ-4678

Metalletui mit 14 Hegar Uterusdilatoren  
Scatola con 14 dilatatori uterini Hegar



SSQ-4679

Metalletui mit 13 Hegar Uterusdilatoren  
Scatola con 13 dilatatori uterini Hegar



SSQ-4676  
mit 8 Uterusdilatoren  
con 8 dilatatori uterini



SSQ-4677  
für 8 Uterusdilatoren  
per 8 dilatatori uterini

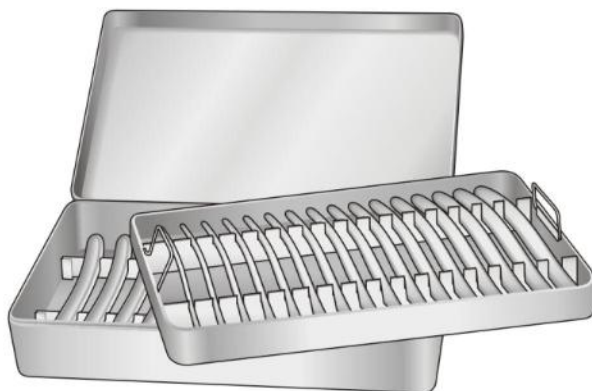

SSQ-4674

Metalletui mit 26 Hegar Uterusdilatoren  
Scatola con 26 dilatatori uterini Hegar

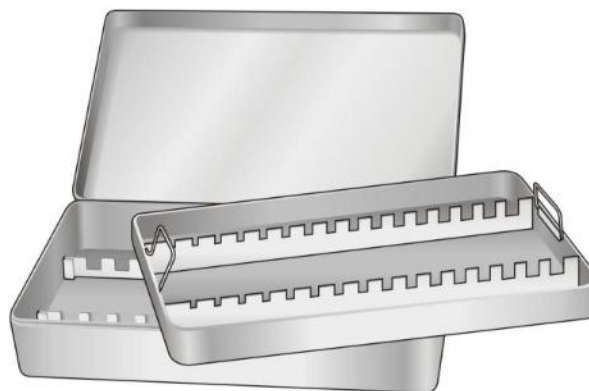

SSQ-4675

Metalletui leer für 26 Hegar Uterusdilatoren  
Scatola vuota per 26 dilatatori uterini Hegar

Uterusdepressor  
Uterine Depressor  
Depressore uterino  
Depresor uterino  
Dépresseur utérin



BRAUN  
SSQ-4682  
275 mm

Sterilisierzangen zum Fassen und Halten Steriler Instrumente  
Sterilizing forceps for picking up and holding of sterile instruments  
Pinze per prelevare strumenti sterilizzati  
Pinzas para esterilizaciòn  
Pincas pour instruments stérilisés

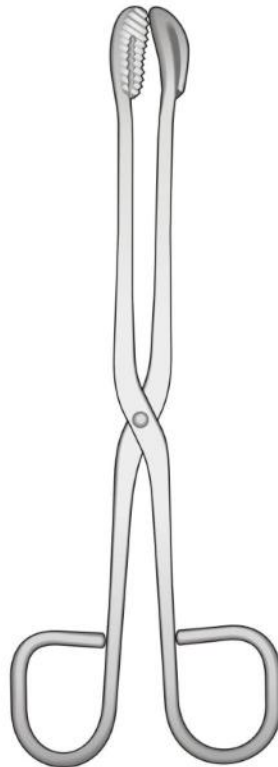

SSQ-4683 200 mm  
SSQ-4683 300 mm

Pinza per rimozione punti metallici

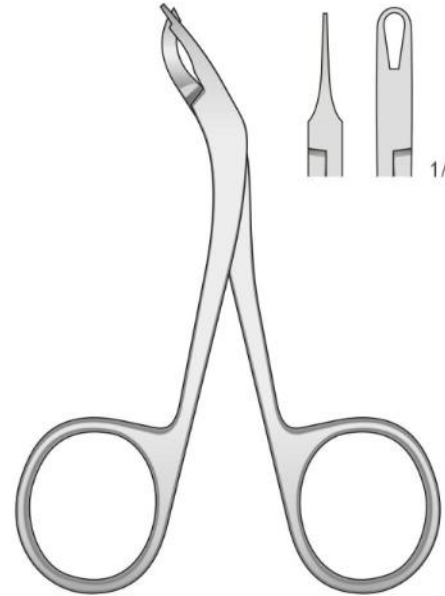

SSQ-4685  
115 mm

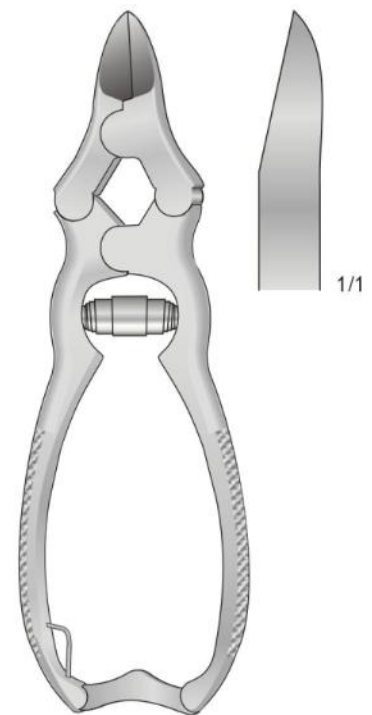

SSQ-4684  
155 mm

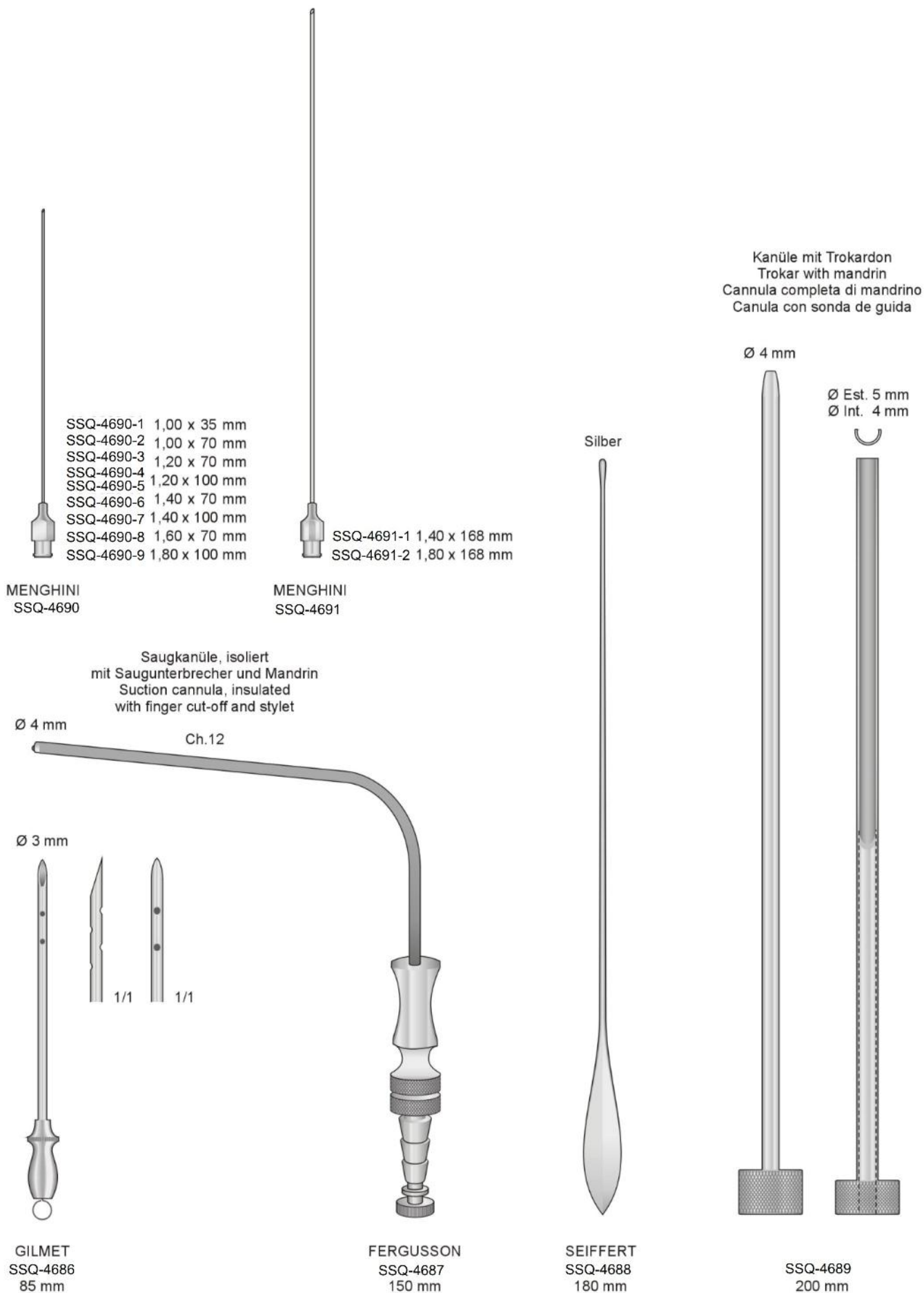

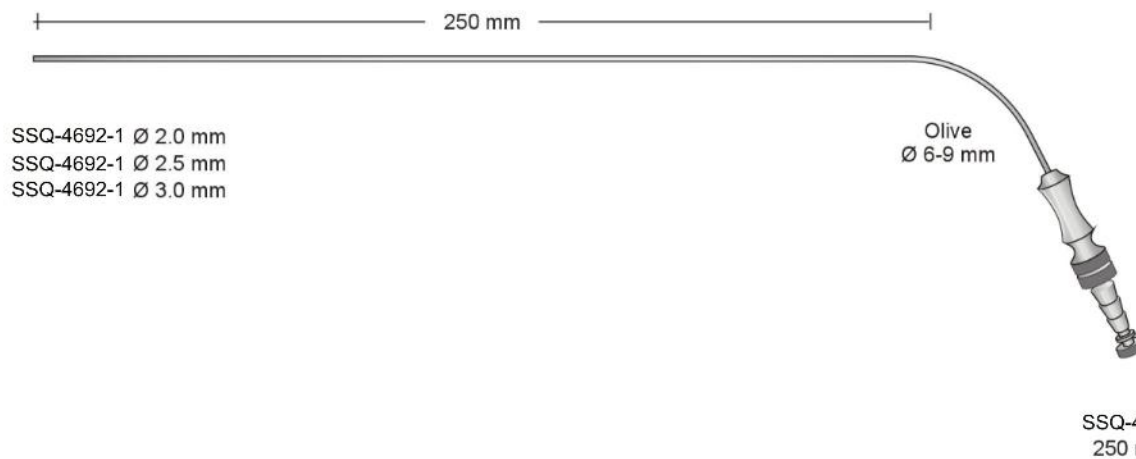
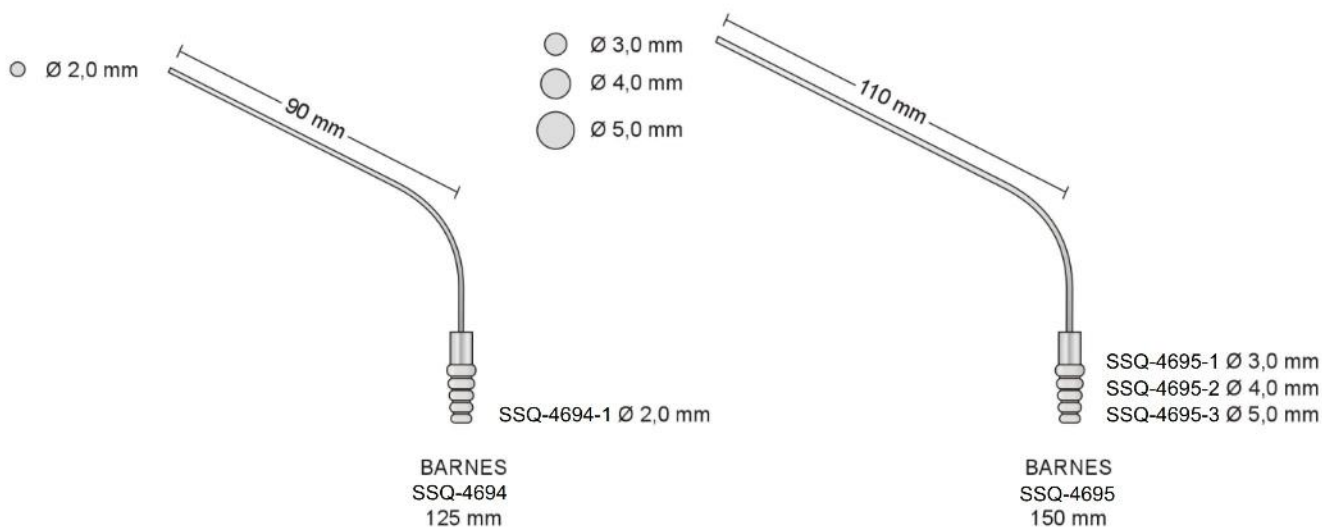
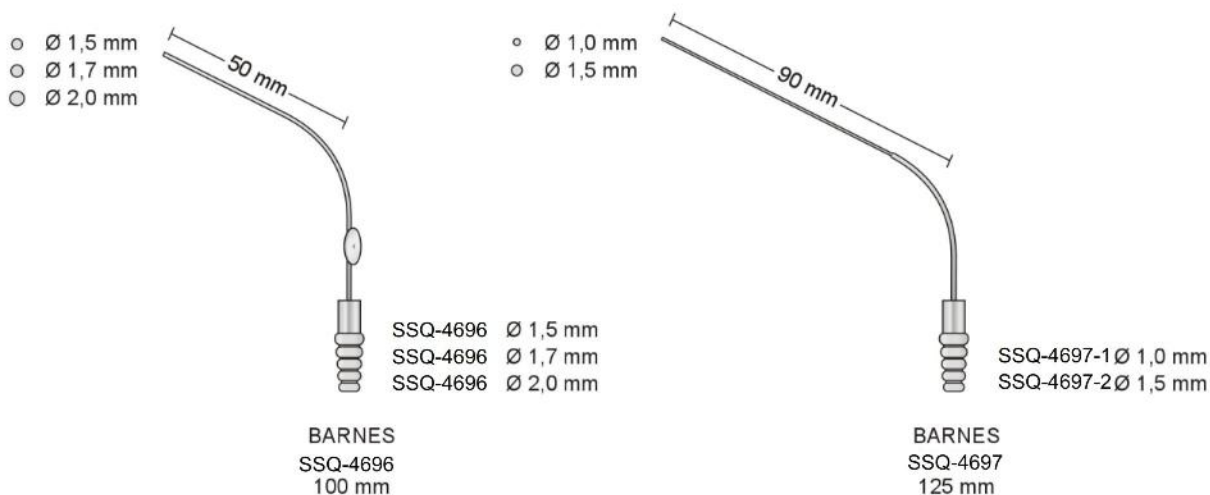

Lunghezza Cannula	No.1 0,6 x 0,4	No.2 0,8 x 0,6	No.3 1,0 x 0,8	No.4 1,2 x 1,0	No.5 1,5 x 1,2	No.6 2,0 x 1,6
SS = 80 mm	SSQ-4698-1	SSQ-4698-2	SSQ-4698-3	SSQ-4698-4	SSQ-4698-5	SSQ-4698-6 For Bypass
S = 100 mm	SSQ-4699-1	SSQ-4699-2	SSQ-4699-3	SSQ-4699-4	SSQ-4699-5	SSQ-4699-6
M = 120 mm	SSQ-4700-1	SSQ-4700-2	SSQ-4700-3	SSQ-4700-4	SSQ-4700-5	SSQ-4700-6
L = 145 mm	SSQ-4701-1	SSQ-4701-2	SSQ-4701-3	SSQ-4701-4	SSQ-4701-5	SSQ-4701-6
LL = 160 mm	SSQ-4702-1	SSQ-4702-2	SSQ-4702-3	SSQ-4702-4	SSQ-4702-5	SSQ-4702-6 For Trans-sphenoidal
LLL = 175 mm	SSQ-4703-1	SSQ-4703-2	SSQ-4703-3	SSQ-4698-4	SSQ-4703-5	SSQ-4703-6 For Trans-sphenoidal

Char. 1 = 0,3 mm
Char. 2 = 0,6 mm
Char. 3 = 1,0 mm
Char. 4 = 1,3 mm
Char. 5 = 1,6 mm
Char. 6 = 2,0 mm
Char. 7 = 2,3 mm
Char. 8 = 2,6 mm
Char. 9 = 3,0 mm
Char. 10 = 3,3 mm

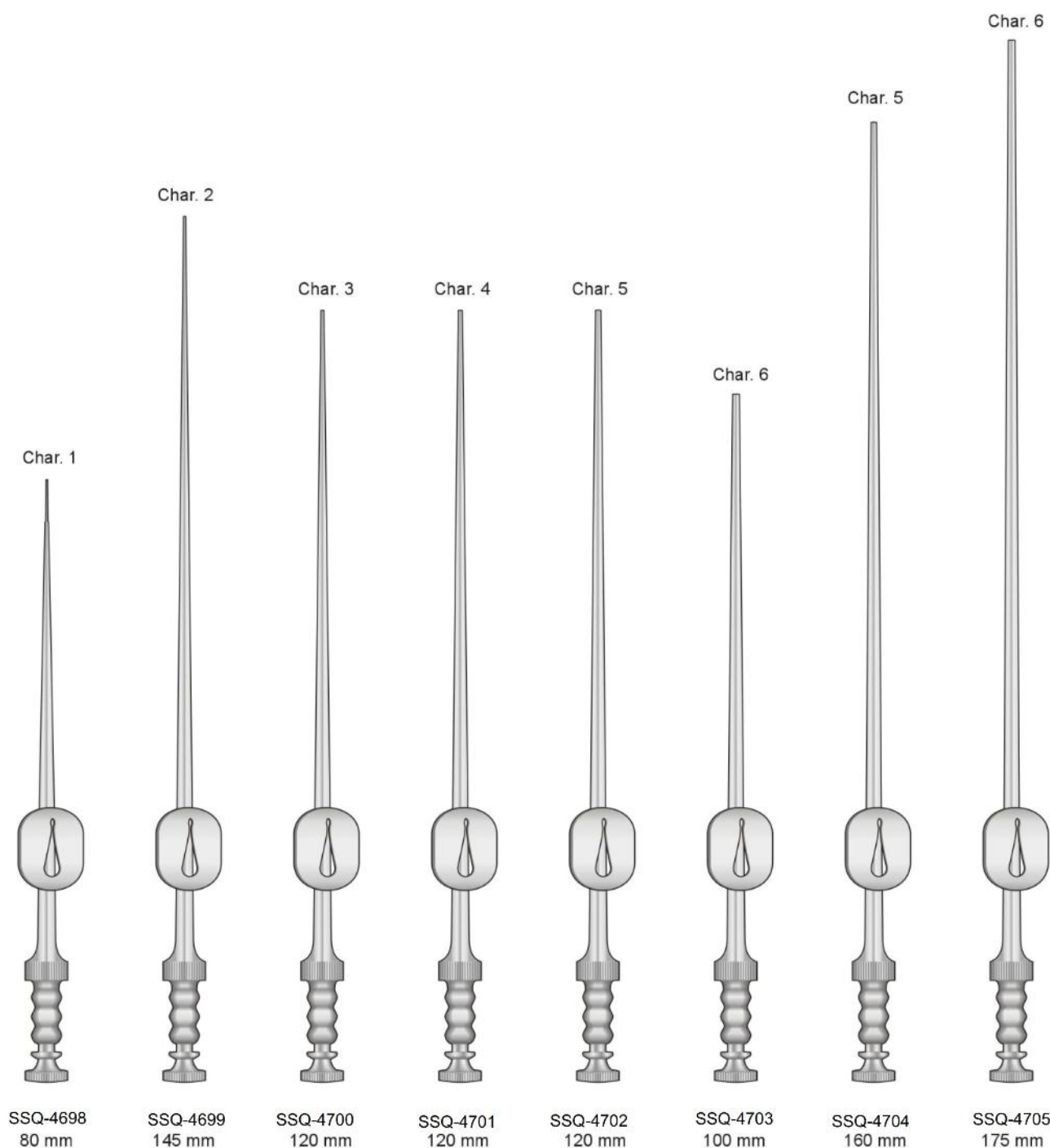

SSQ-4713

Lunghezza Cannula	No.7 2,5 x 1,9	No.8 3,0 x 2,2	No.9 3,5 x 2,5	No.10 4,0 x 3,0
M = 120 mm	SSQ-4706-1	SSQ-4706-2	SSQ-4706-3	SSQ-4706-4
L = 145 mm	SSQ-4707-1	SSQ-4707-2	SSQ-4707-3	SSQ-4707-4
LL = 160 mm	SSQ-4708-1	SSQ-4708-2	SSQ-4708-3	SSQ-4708-4 For Trans-sphenoidal
LLL = 175 mm	SSQ-4709-1	SSQ-4709-2	SSQ-4709-3	SSQ-4709-4 For Trans-sphenoidal

Char. 1	= 0,3 mm
Char. 2	= 0,6 mm
Char. 3	= 1,0 mm
Char. 4	= 1,3 mm
Char. 5	= 1,6 mm
Char. 6	= 2,0 mm
Char. 7	= 2,3 mm
Char. 8	= 2,6 mm
Char. 9	= 3,0 mm
Char. 10	= 3,3 mm

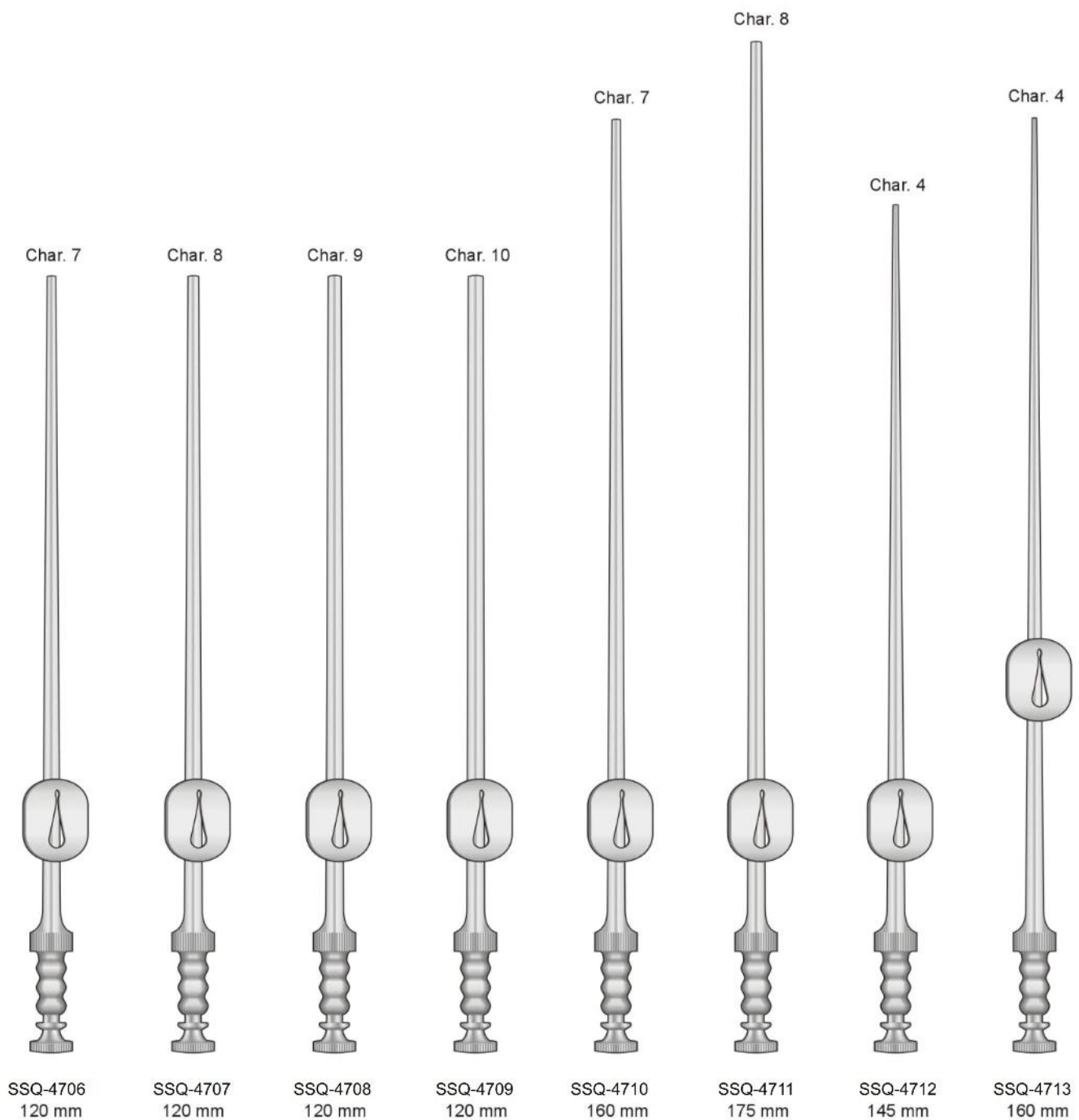

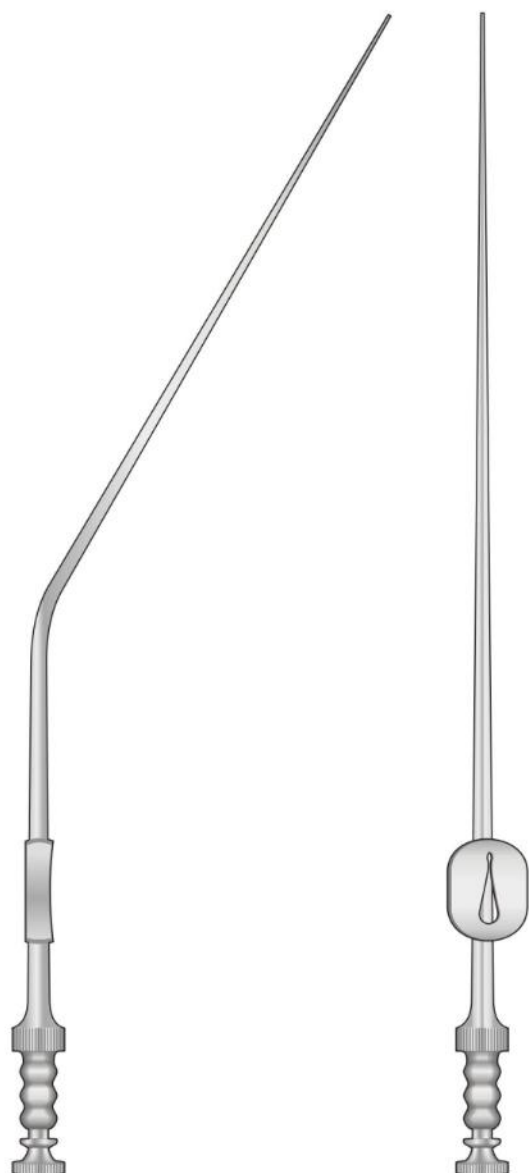

Char. 3	= 1,0 mm
Char. 4	= 1,3 mm
Char. 5	= 1,6 mm
Char. 6	= 2,0 mm
Char. 7	= 2,3 mm
Char. 8	= 2,6 mm
Char. 9	= 3,0 mm
Char. 10	= 3,3 mm
Char. 11	= 3,6 mm
Char. 12	= 4,0 mm

	Lunghezza 160 mm	Lunghezza 180 mm	Lunghezza 205 mm
Char. 3	SSQ-4714-1	SSQ-4714-11	SSQ-4714-21
Char. 4	SSQ-4714-2	SSQ-4714-12	SSQ-4714-22
Char. 5	SSQ-4714-3	SSQ-4714-13	SSQ-4714-23
Char. 6	SSQ-4714-4	SSQ-4714-14	SSQ-4714-24
Char. 7	SSQ-4714-5	SSQ-4714-15	SSQ-4714-25
Char. 8	SSQ-4714-6	SSQ-4714-16	SSQ-4714-26
Char. 9	SSQ-4714-7	SSQ-4714-17	SSQ-4714-27
Char. 10	SSQ-4714-8	SSQ-4714-18	SSQ-4714-28
Char. 11	SSQ-4714-9	SSQ-4714-19	SSQ-4714-29
Char. 12	SSQ-4714-10	SSQ-4714-20	SSQ-4714-30



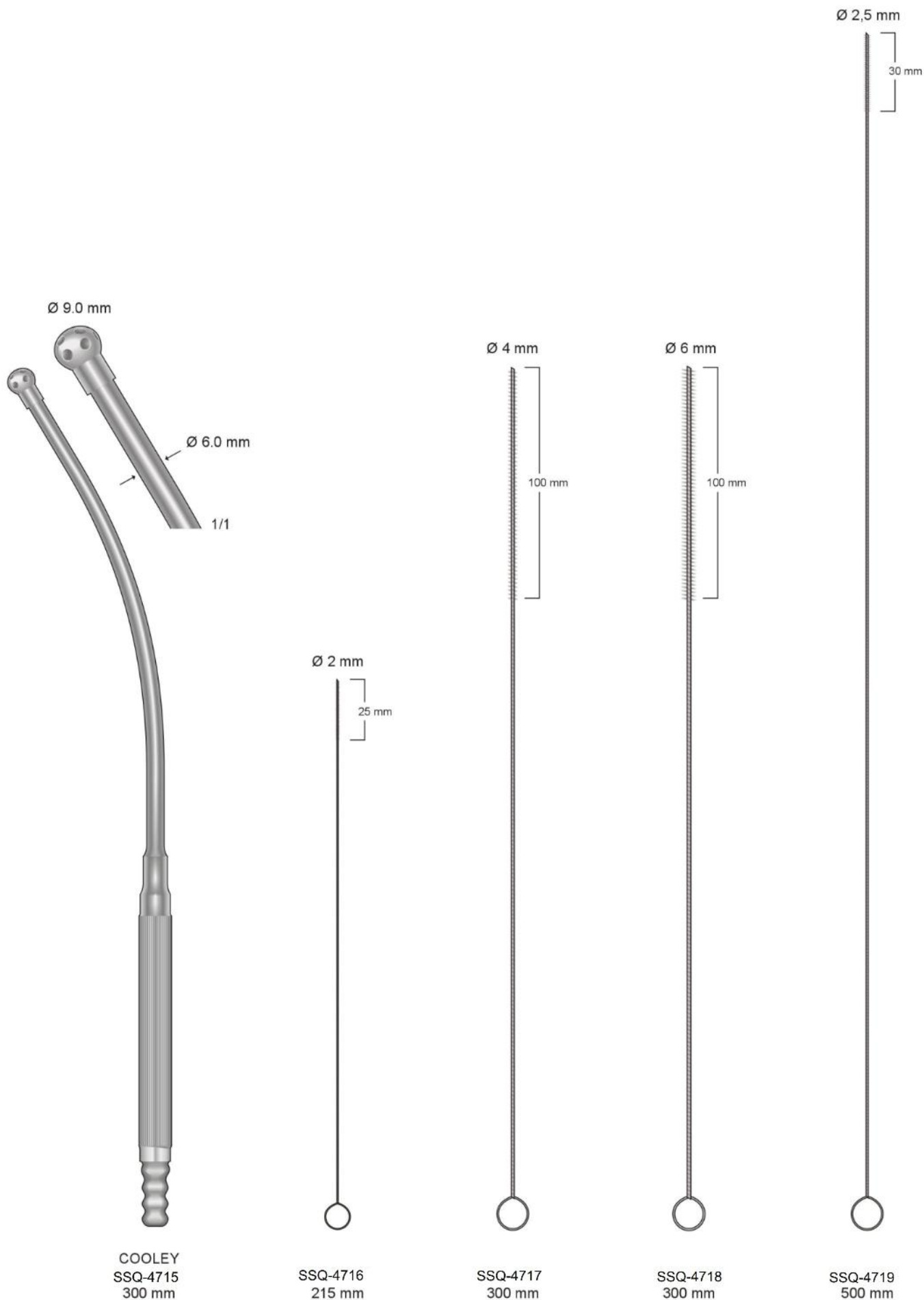

**mm:** Schnittlänge  
Lenght of blades  
Lunghezza della lama  
Largo de hojas  
Longueur de la lame

Metallheft  
Metal handle  
Manico in metallo  
Mango metálico  
Manche métal

Holzheft  
Wooden handle  
Manico in legno  
Mango de madera  
Manche bois

Metallheft  
Metal handle  
Manico in metallo  
Mango metálico  
Manche métal

Metallheft  
Metal handle  
Manico in metallo  
Mango metálico  
Manche métal

Resektionsmesser  
Resection knives  
Coltello per resezione  
Cuchillos para resección  
Couteaux à résection

Organmesser  
Post mortem knives  
Coltello per autopsia  
Cuchillos para órganos  
Couteaux à autopsie

Organmesser  
Post mortem knives  
Coltello per autopsia  
Cuchillos para órganos  
Couteaux à autopsie

Hirnmesser  
Brain knives  
Coltello per cervello  
Cuchillos para cerebro  
Couteaux à cerveau

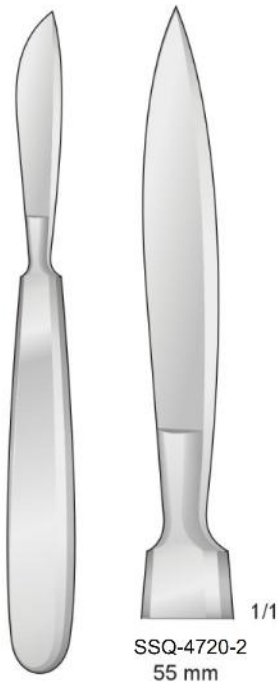

LANGENBECK  
SSQ-4720  
55 mm

SSQ-4721  
110 mm

SSQ-4722  
170 mm

SSQ-4723  
195 mm

VIRCHOW  
SSQ-4724  
160 mm

VIRCHOW  
SSQ-4725  
200 mm

VIRCHOW  
SSQ-4726  
240 mm

Dermatome komplett mit 1 auswechselbarer Klinge und 2 Spannplatten  
 Dermatome complete with 1 interchangeable blade and 2 skin plates  
 Dermatomo a mano, con una lama intercambiabile, completo di 2 placche per stendere la pelle  
 Dermatomo completo, con 1 hoja intercambiable y 2 placas para extender la piel  
 Dermatome avec 1 lame interchangeable et 2 plaques pour tendre la peau

Einstellbar von 0,1 bis 3,0 mm  
 Adjustable from 0,1 to 3,0 mm  
 Regolazione da 0,1 a 3,0 mm  
 Regulable de 0,1 hasta 3,0 mm  
 Réglable en épaisseur de 0,1 à 3,0 mm

Einstellbar von 0,1 bis 4,0 mm  
 Adjustable from 0,1 to 4,0 mm  
 Regolazione da 0,1 a 4,0 mm  
 Regulable de 0,1 hasta 4,0 mm  
 Réglable en épaisseur de 0,1 à 4,0 mm

Für handelsübliche Rasierklingen  
 For usual razor blades  
 Per lamette standard  
 Para hojas de afeitar usuales  
 Pour lames de rasoir modèle standard

Spanplatte  
 Skin Fixing Plate  
 Placca per stendere la pelle  
 Placa para extender la piel  
 Plaque pour tendre la peau



SCHINK  
SSQ-4727



SILVER  
SSQ-4728  
190 mm

Ersatzklinge, allein  
 Spare Blade only  
 Lama di ricambio sola  
 Hoja de repuesto  
 Lame de rechange, seule



SILVER  
SSQ-4729  
43 mm

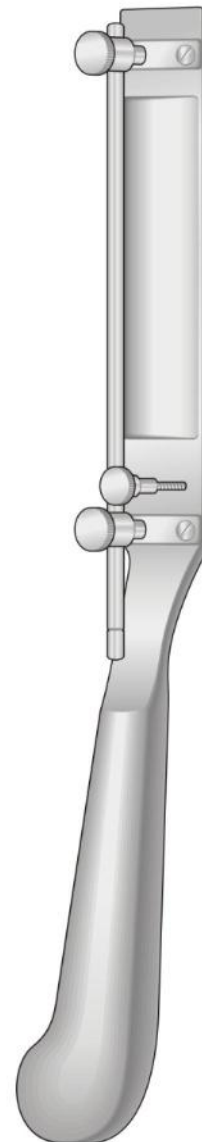

SCHINK  
SSQ-4730  
300 mm

Ersatzklinge, allein  
 Spare Blade only  
 Lama di ricambio sola  
 Hoja de repuesto  
 Lame de rechange, seule



SCHINK  
SSQ-4731  
102 mm

Dermatome komplett mit 1 auswechselbarer Klinge und 2 Spannplatten  
 Dermatome complete with 1 interchangeable blade and 2 skin plates  
 Dermatomo a mano, con una lama intercambiabile, completo di 2 placche per stendere la pelle  
 Dermatomo completo, con 1 hoja intercambiabile y 2 placas para extender la piel  
 Dermatome avec 1 lame interchangeable et 2 plaques pour tendre la peau

Einstellbar von 0,1 bis 1,5 mm  
 Adjustable from 0,1 to 1,5 mm  
 Regolazione da 0,1 a 1,5 mm  
 Regulable de 0,1 hasta 1,5 mm  
 Réglable en épaisseur de 0,1 à 1,5 mm

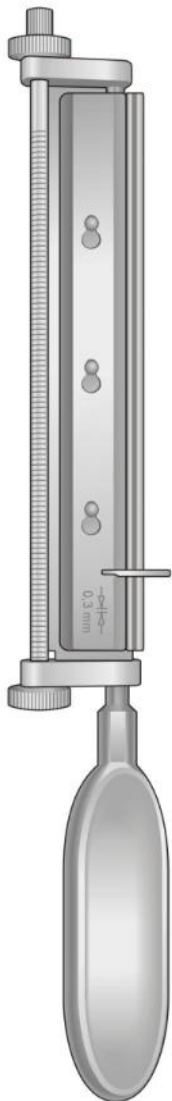

WATSON  
SSQ-4732  
300 mm

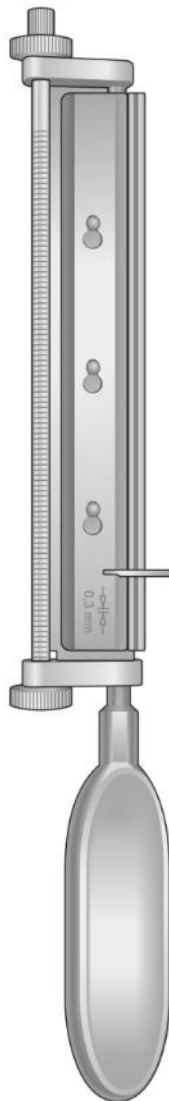

COBBETT  
SSQ-4733  
300 mm

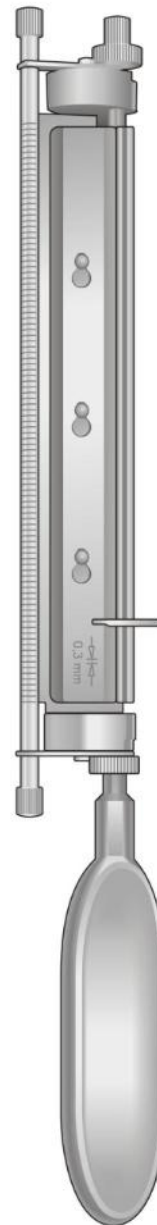

HUMBY  
SSQ-4734  
320 mm

Ersatzklinge, allein  
 Spare Blade only  
 Lama di ricambio sola  
 Hoja de repuesto  
 Lame de rechange, seule



HUMBY  
SSQ-4735  
157 mm

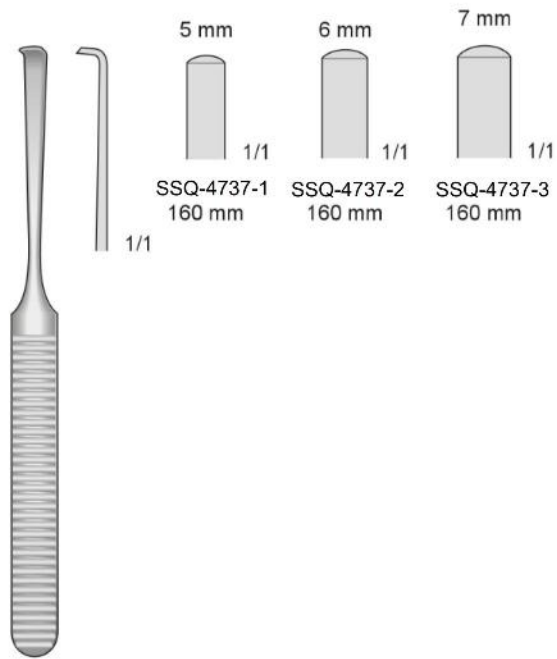

SSQ-4737  
160 mm

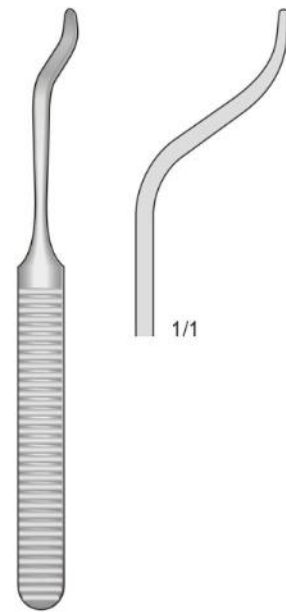

SSQ-4738  
160 mm

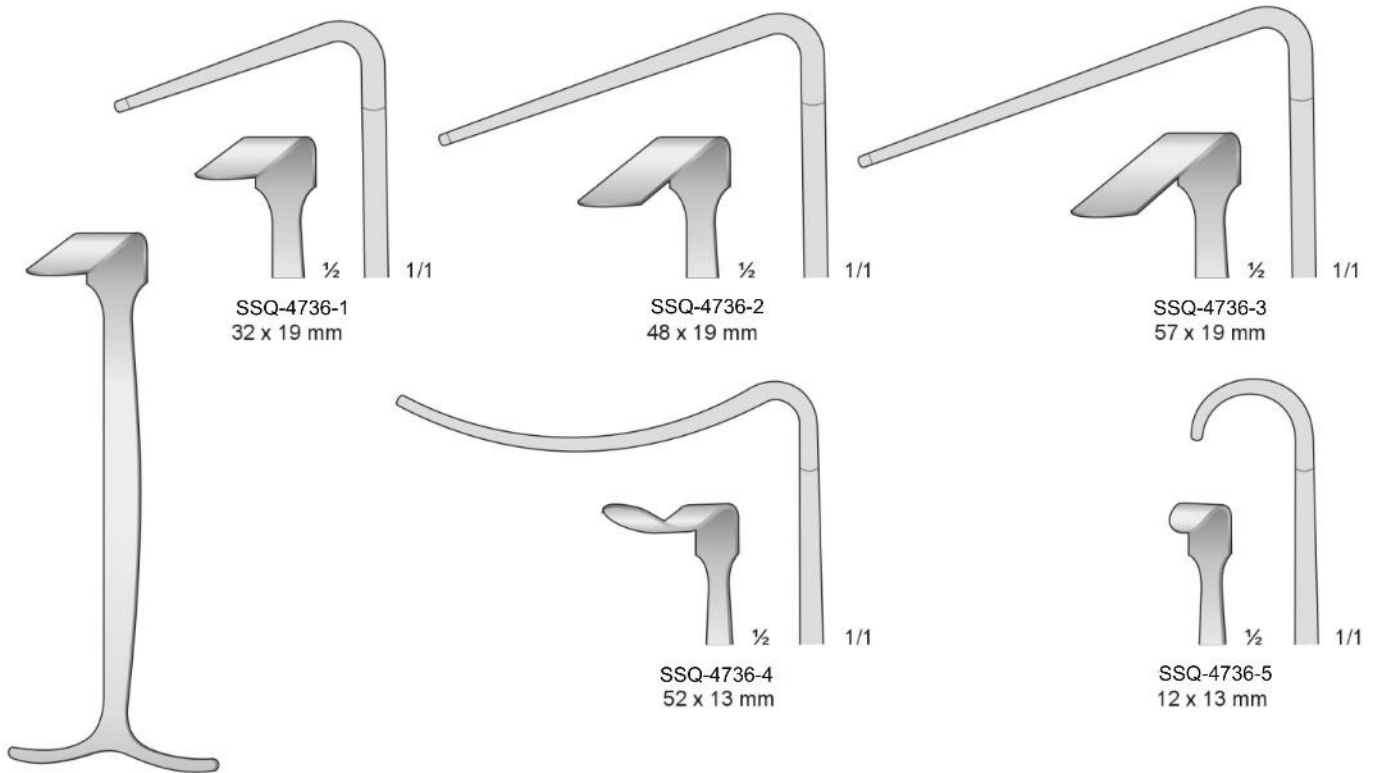

SMILLIE  
SSQ-4736  
140 mm

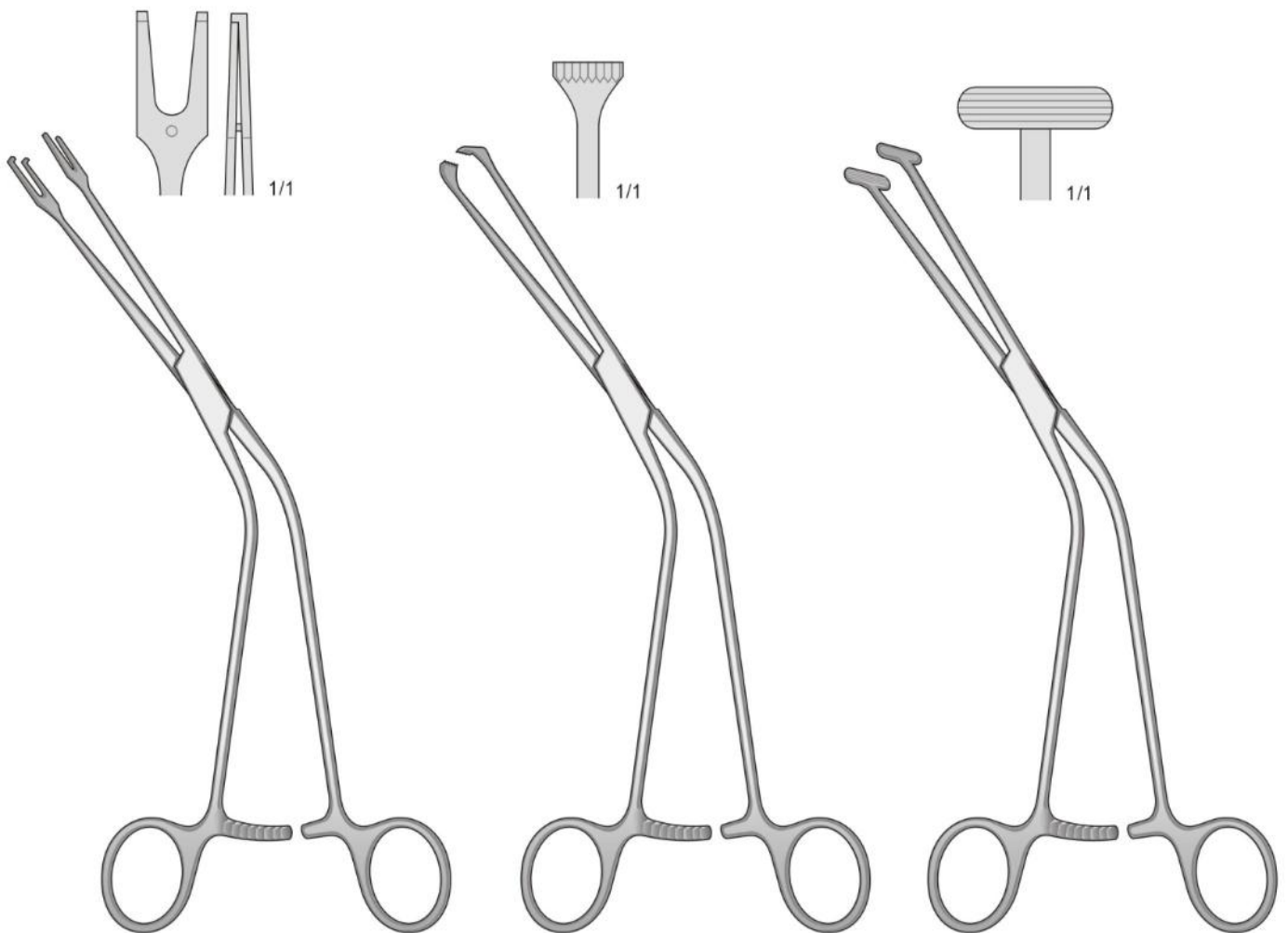

MILLIN  
SSQ-4739  
245 mm

MILLIN  
SSQ-4740  
220 mm

MILLIN  
SSQ-4741  
245 mm

Atraumatische - Atraumatic  
Atraumatiche - Atraumáticas  
Atraumatiques

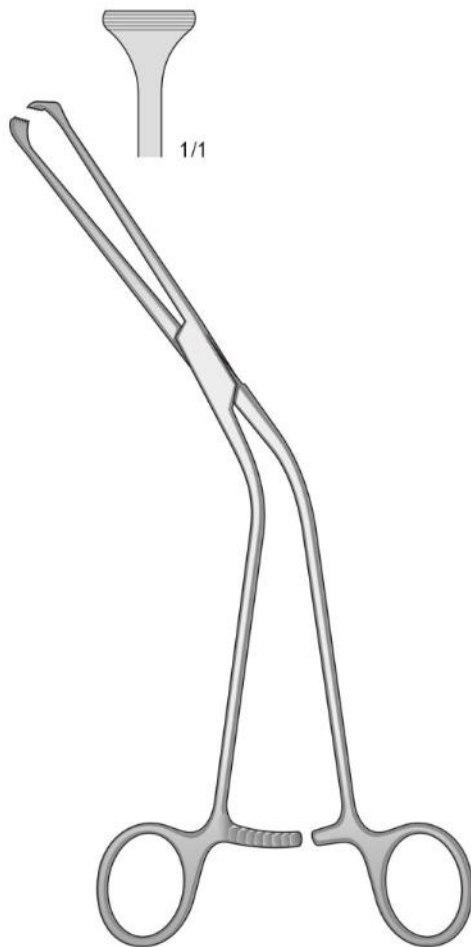

MILLIN  
SSQ-4742  
220 mm

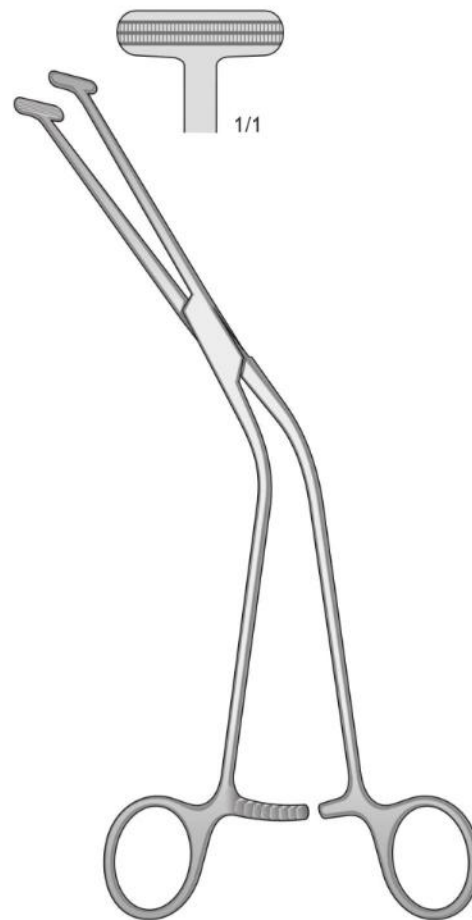

MILLIN  
SSQ-4743  
245 mm

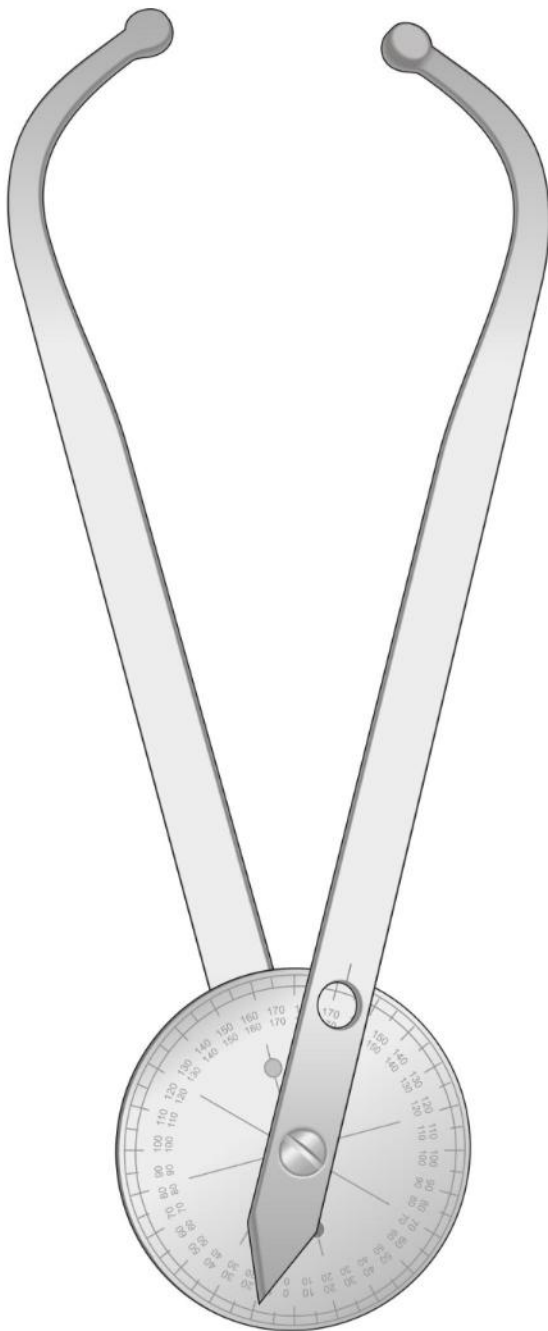

SSQ-4744  
240 mm

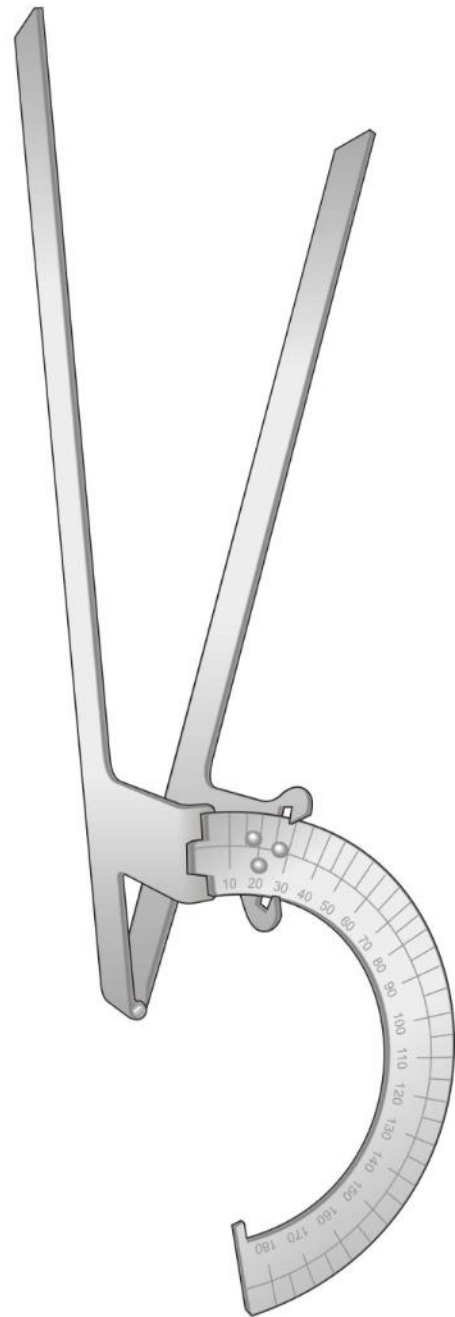

SSQ-4745  
235 mm





*Manufacturer & Exporter Of Surgical Instruments.*

☎ +92-52-3532361  
☎ +92 (302) 775 4954 | +92 (301) 618 3770  
✉ [ssqintl1@gmail.com](mailto:ssqintl1@gmail.com) | [info@ssqintl.com](mailto:info@ssqintl.com)  
📍 Kotli Loharan West, Near Chella, Sialkot - Pakistan



[www.ssqintl.com](http://www.ssqintl.com)