

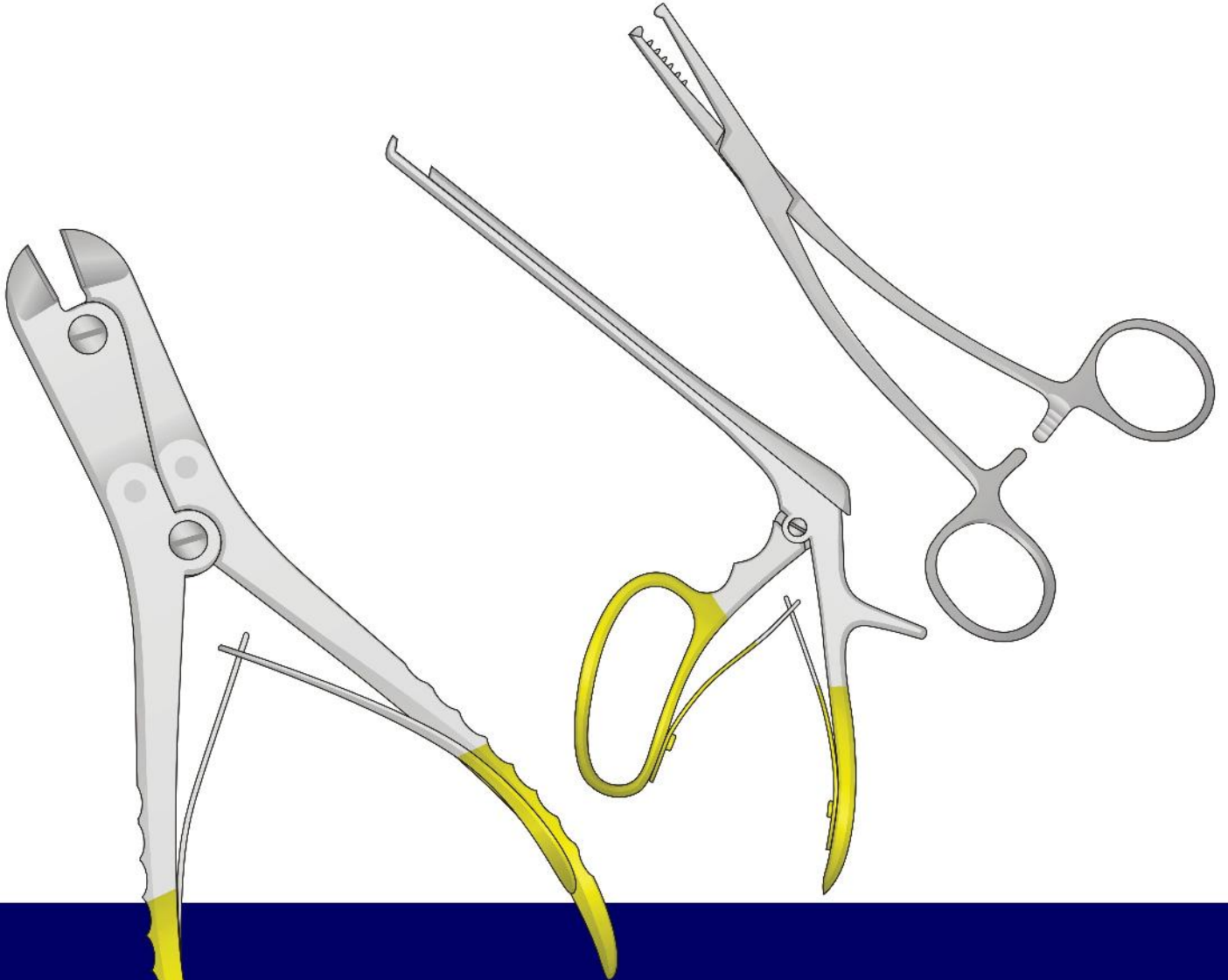

**INTERNATIONAL**

LET'S SHARE ABOUT SURGERY



# *Bone Surgery Laminectomy*



[www.ssqintl.com](http://www.ssqintl.com)

**Surgical  
Instruments  
Catalogue**

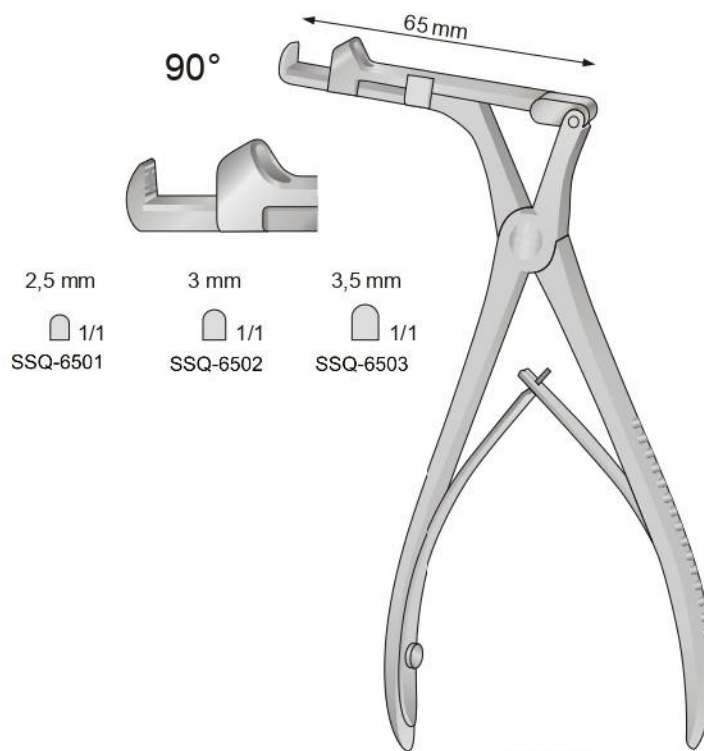

CITELLI  
 SSQ-6501 2,5 mm  
 SSQ-6502 3 mm  
 SSQ-6503 3,5 mm

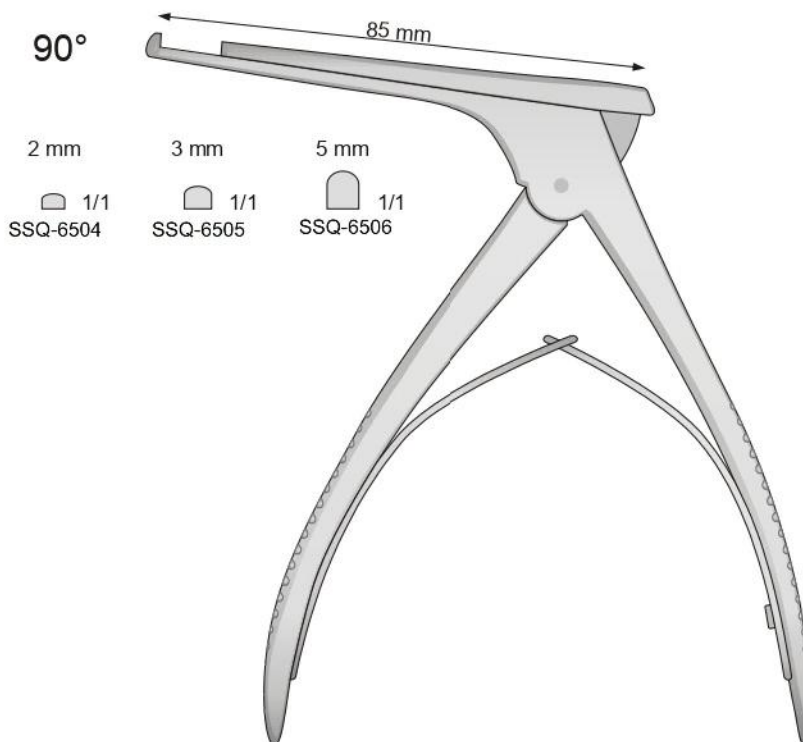

KERRISON  
 SSQ-6504 2 mm  
 SSQ-6505 3 mm  
 SSQ-6506 5 mm

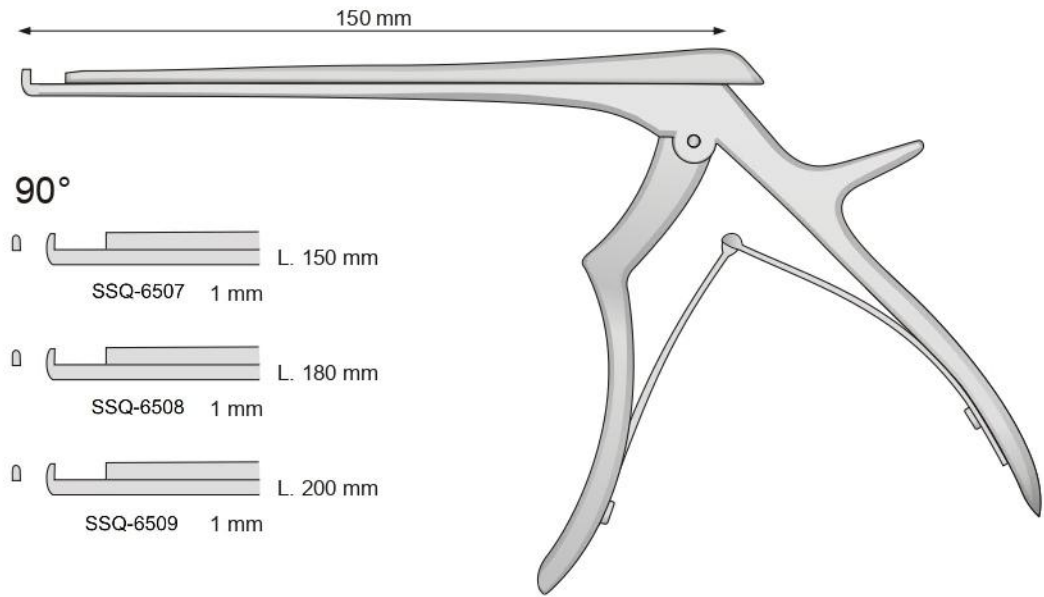

FERRIS-SMITH-KERRISON  
SSQ-6507

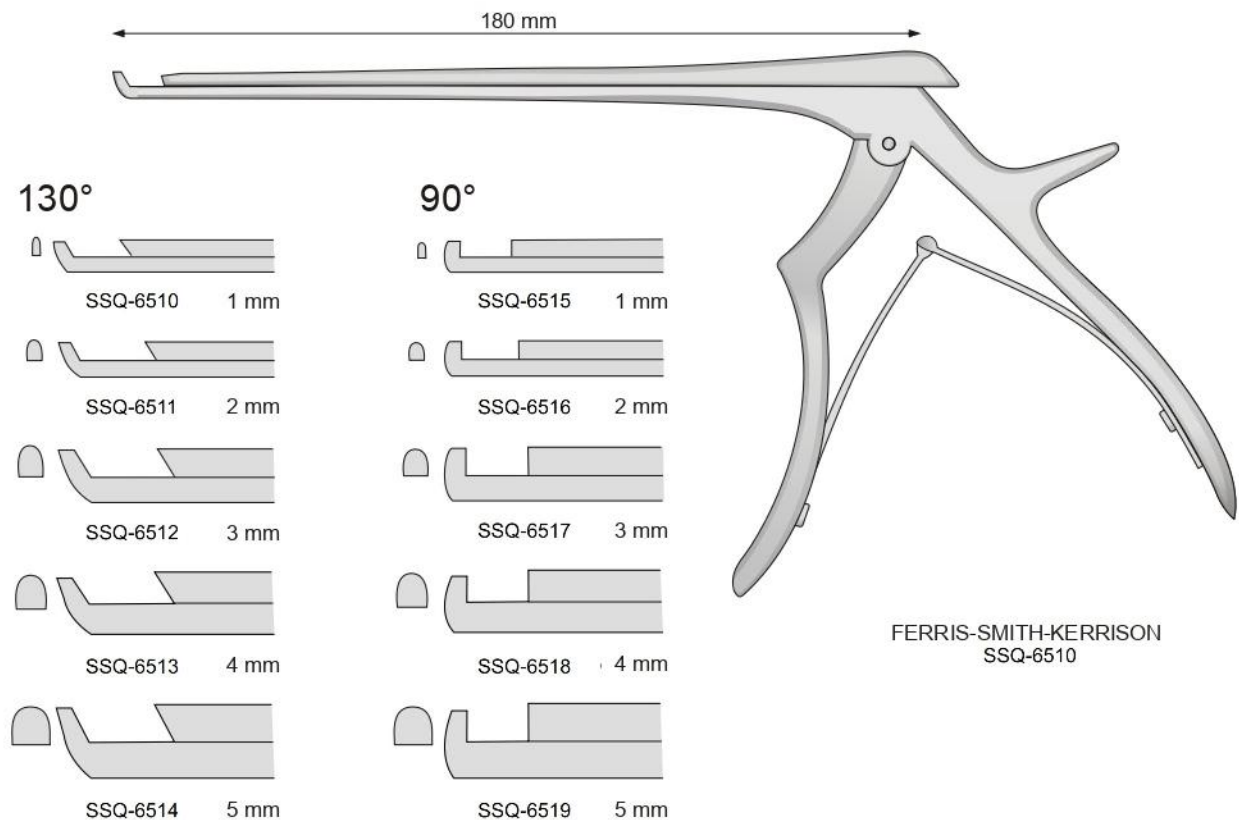

FERRIS-SMITH-KERRISON  
SSQ-6510

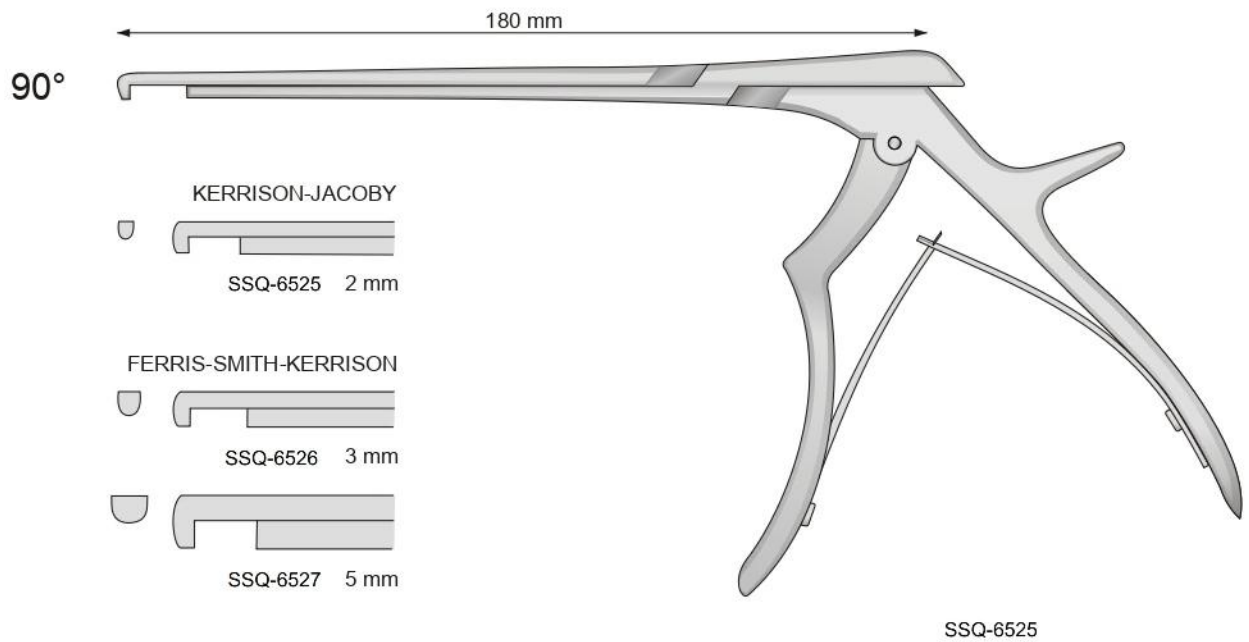
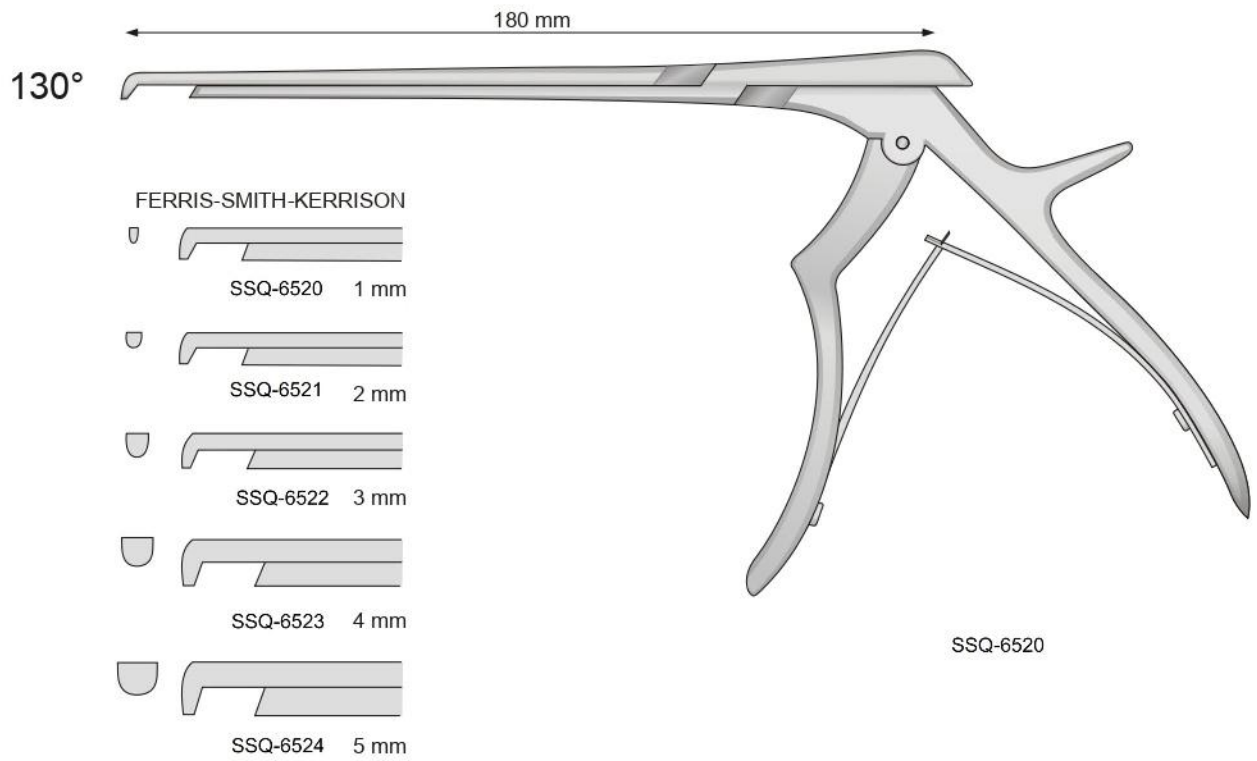

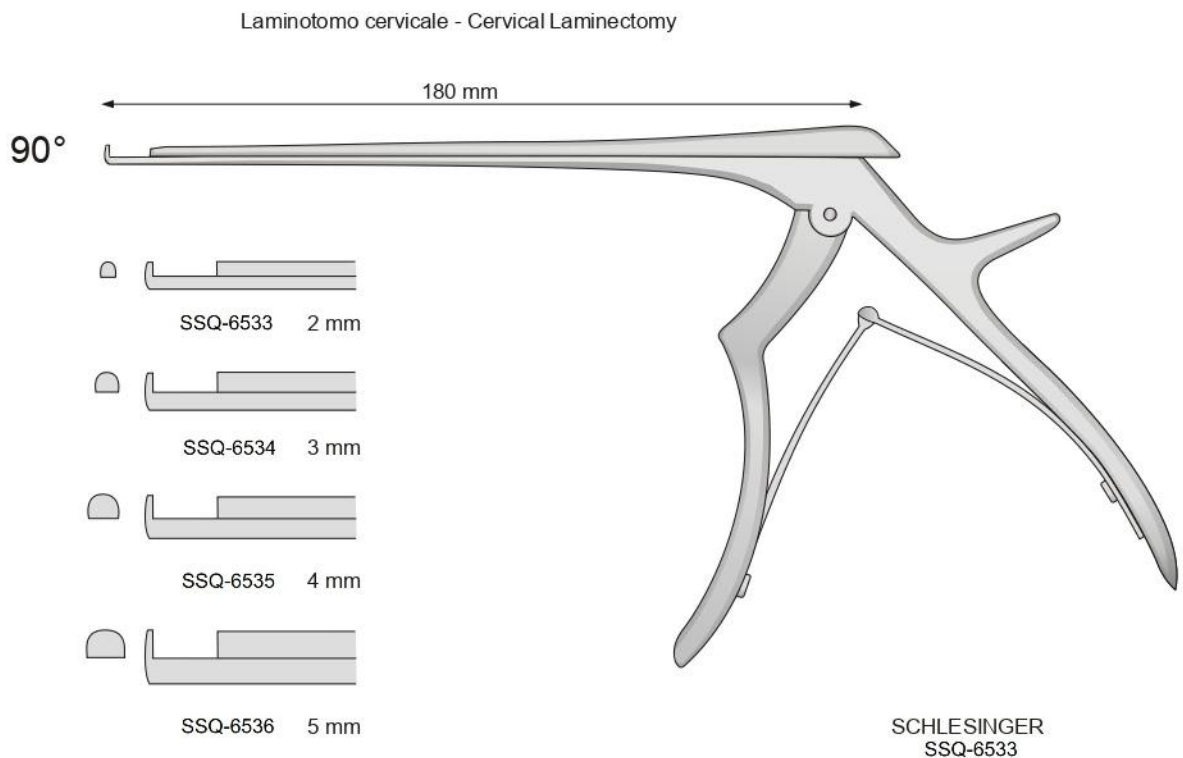
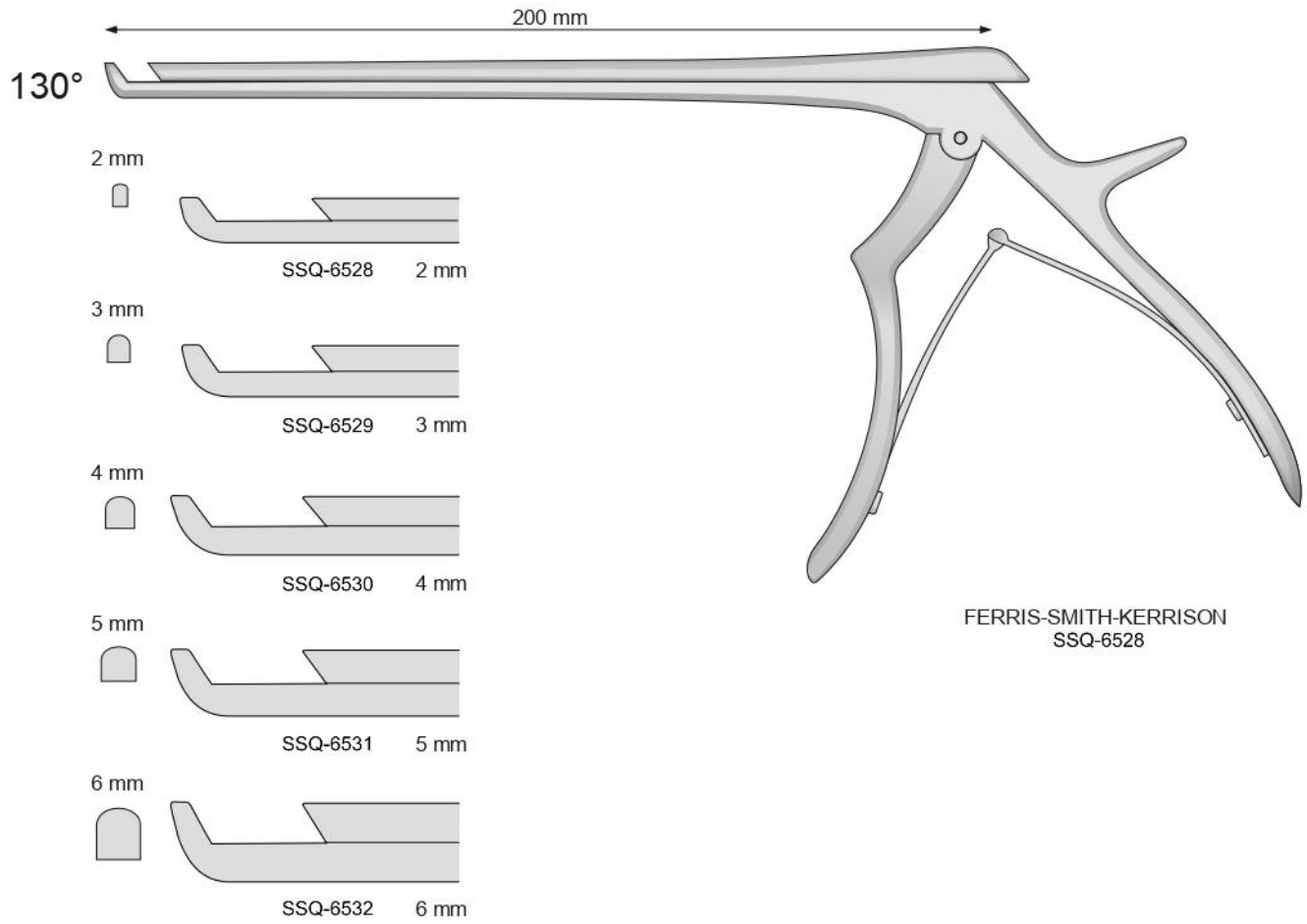

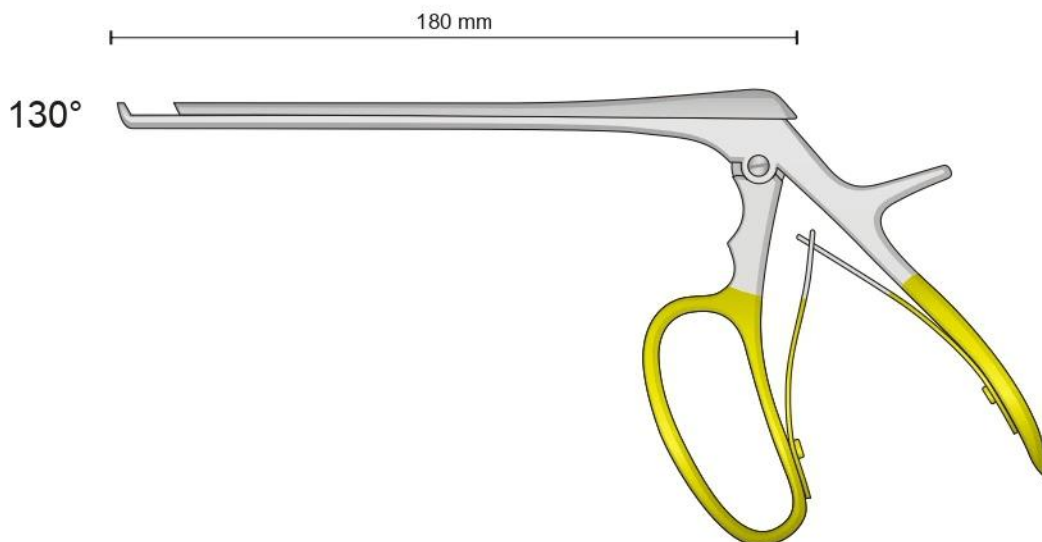
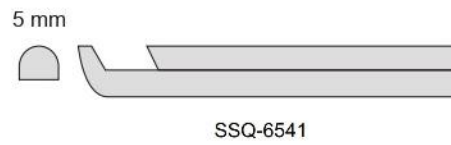
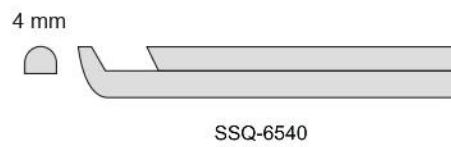
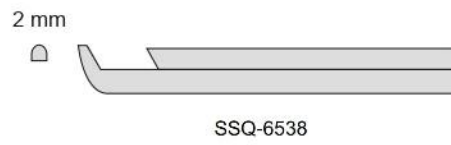
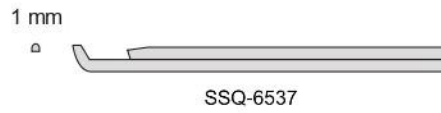





FERRIS - SMITH - KERRISON  
SSQ-6537



Diritta  
Stright  
Gerade  
Droites  
Rectas



	SSQ-6542	x 10 mm
	SSQ-6543	x 10 mm
	SSQ-6544	x 10 mm
	SSQ-6545	x 12 mm

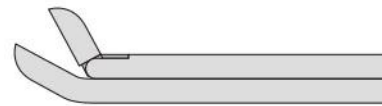

Curva verso l'alto  
Top curved  
Aufwärtsgebogen  
Courbe vers le haut  
Curvos

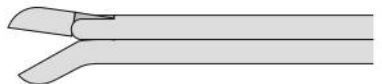

	SSQ-6546	x 10 mm
	SSQ-6547	x 10 mm
	SSQ-6548	x 10 mm

Curva verso il basso  
Bottom curved  
Abwärts gebogen  
Courbe vers le bas  
Curvos



	SSQ-6549	x 10 mm
	SSQ-6550	x 10 mm
	SSQ-6551	x 10 mm

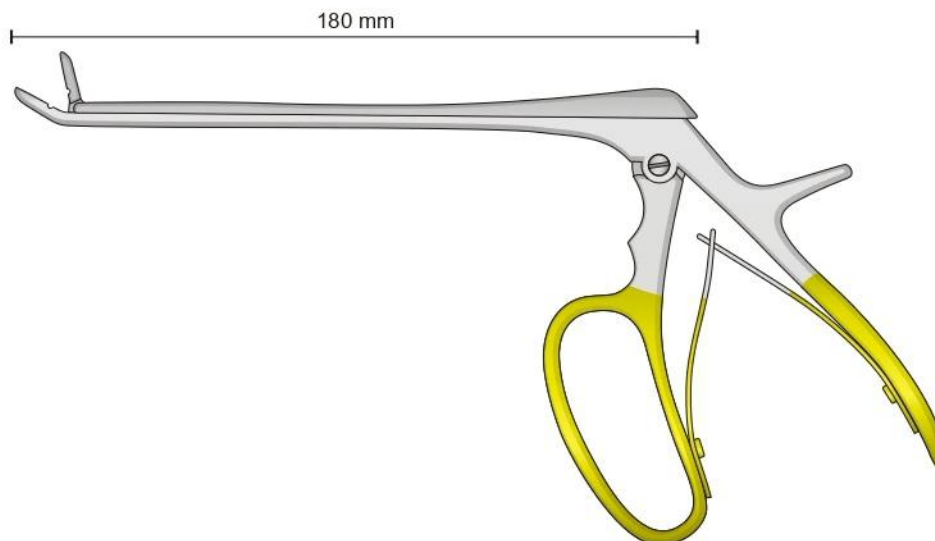

FERRIS - SMITH - CUSHING  
SSQ-6542

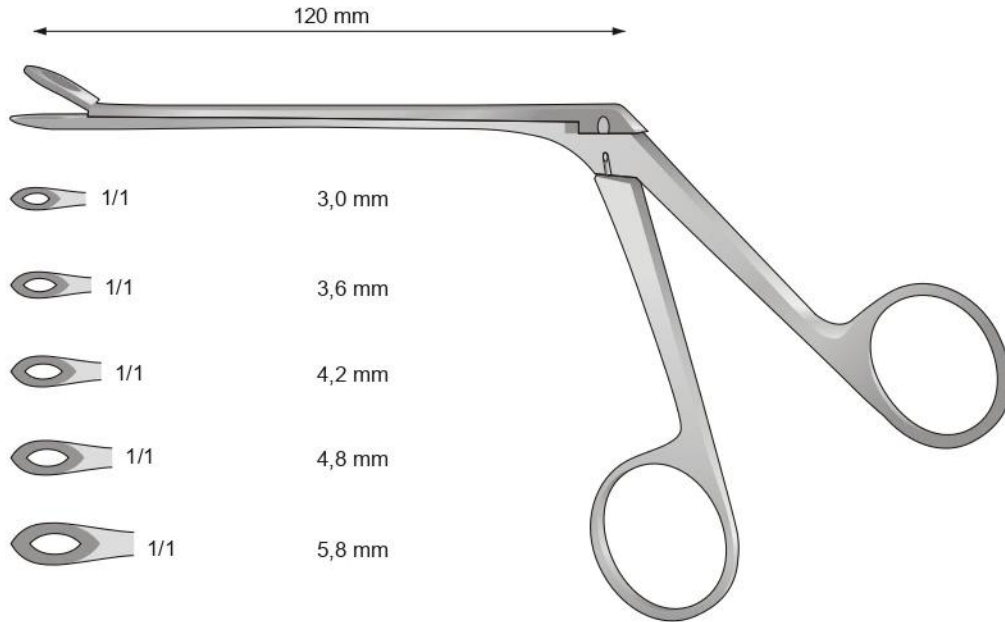

WEIL-BLAKESLEY  
SSQ-6552  
190mm

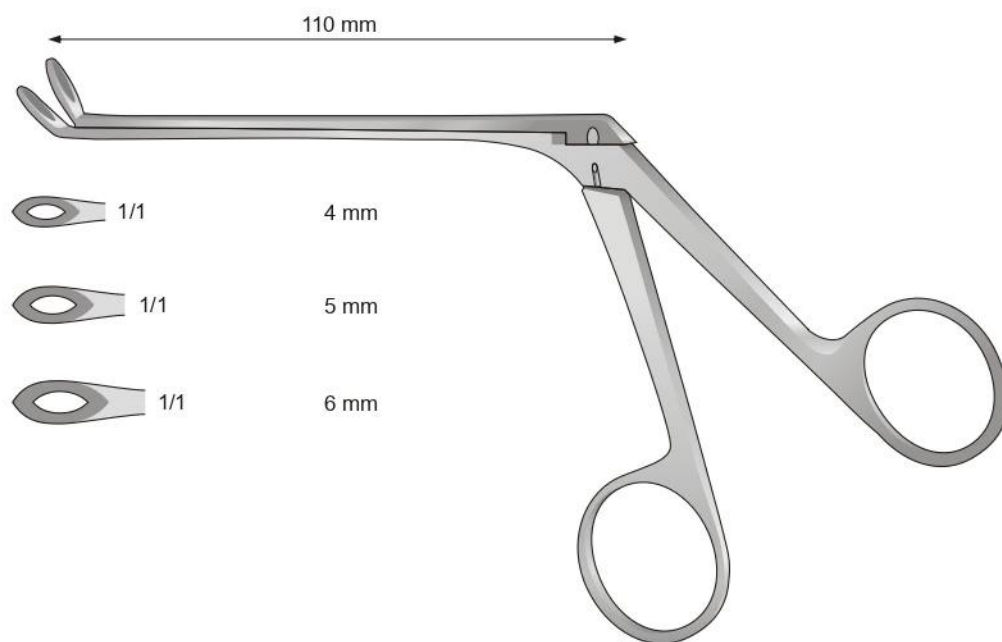

WEIL-BLAKESLEY  
SSQ-6553  
190mm



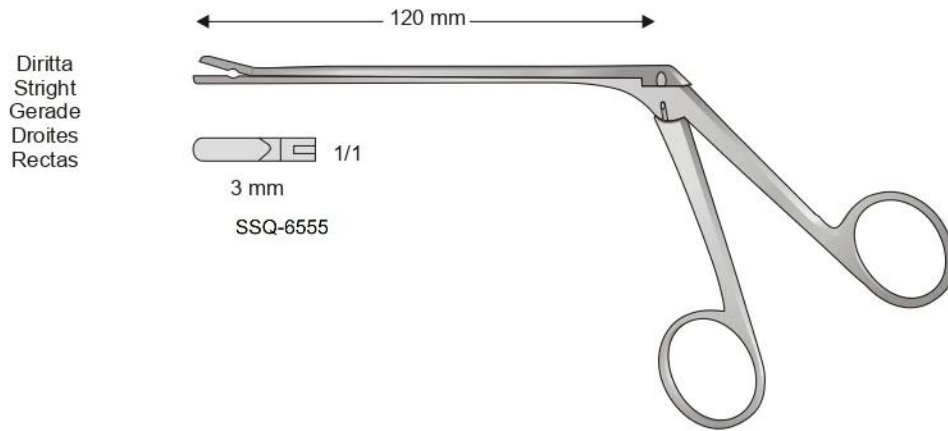

TAKAHASHI  
SSQ-6554

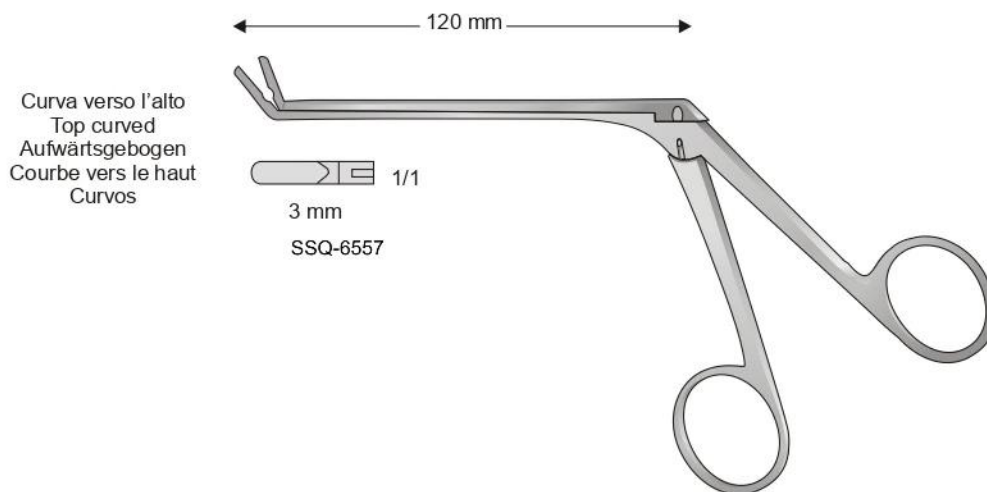

TAKAHASHI  
SSQ-6556

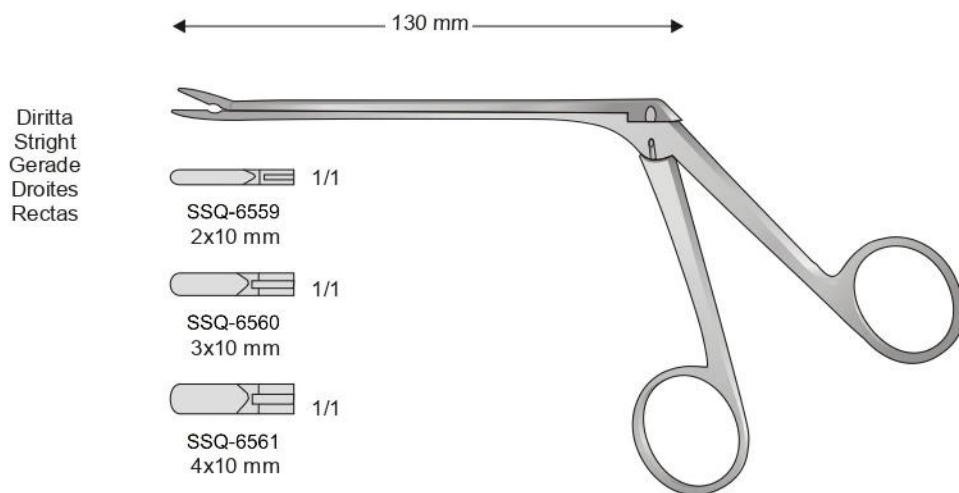

LOVE-GRUENWALD  
SSQ-6558

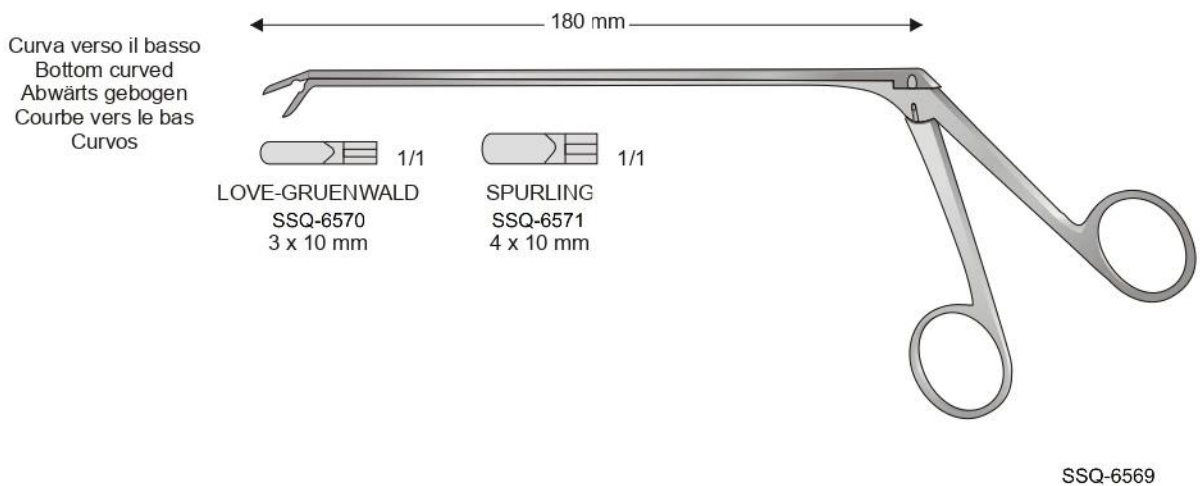
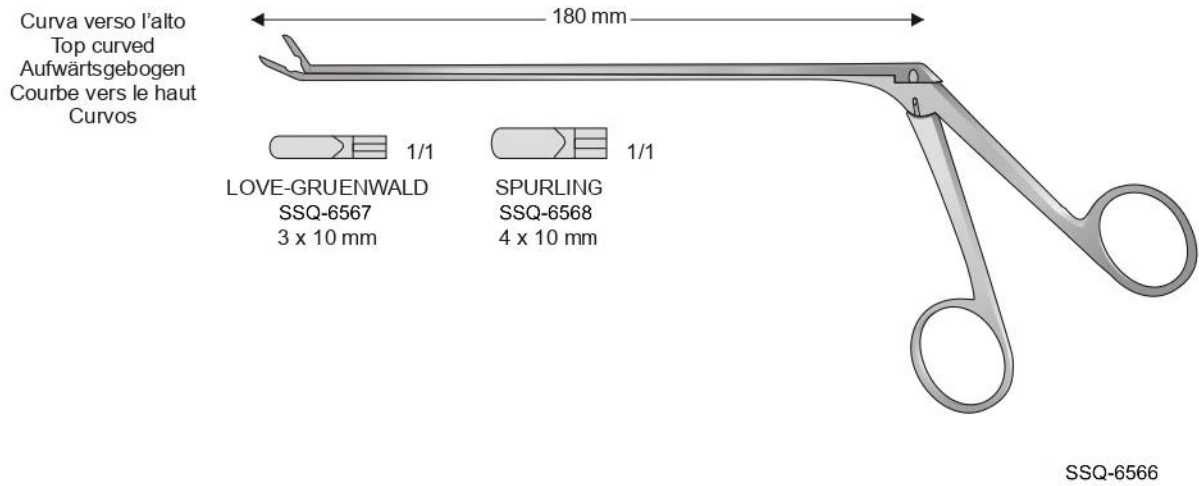
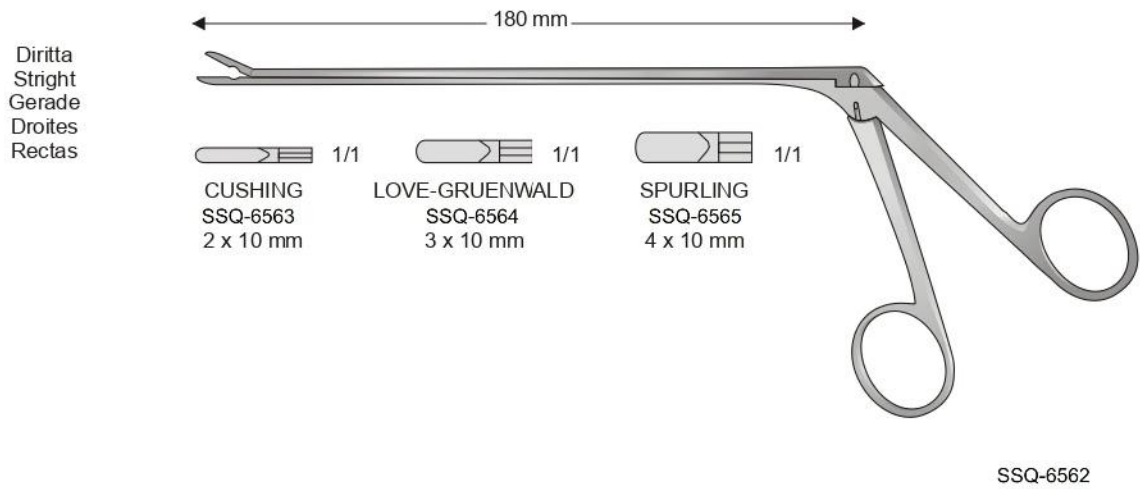

Diritta  
Stright  
Gerade  
Droites  
Rectas

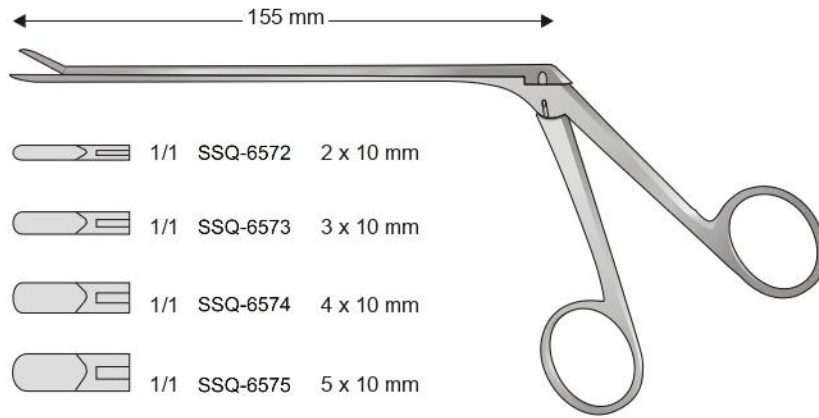

CASPAR  
SSQ-6572

Curva verso l'alto  
Top curved  
Aufwärtsgebogen  
Courbe vers le haut  
Curvos

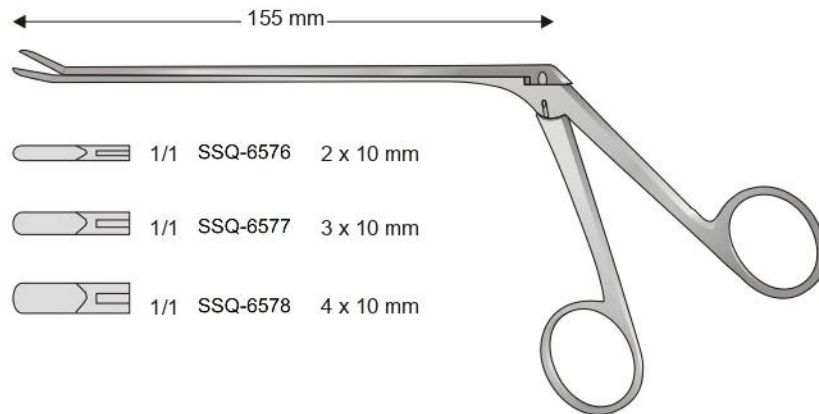

CASPAR  
SSQ-6576

Curva verso il basso  
Bottom curved  
Abwärts gebogen  
Courbe vers le bas  
Curvos

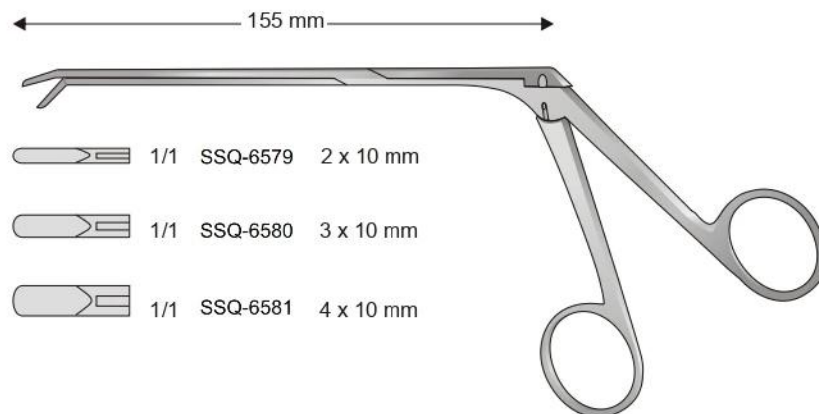



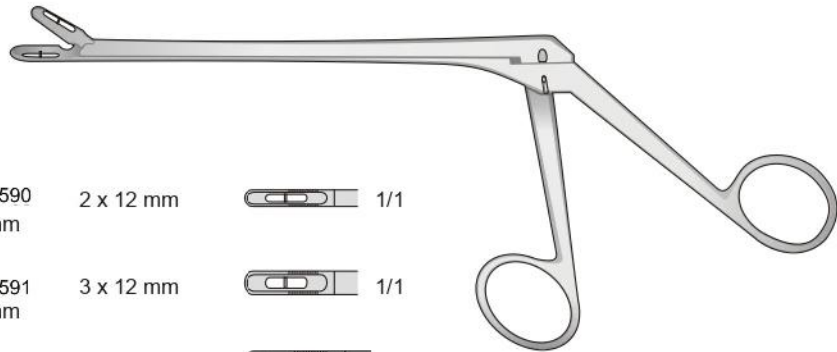

CASPAR  
SSQ-6579

Diritta  
Stright  
Gerade  
Droites  
Rectas



CASPAR

SSQ-6582 140 mm	SSQ-6585 160 mm	SSQ-6590 185 mm	2 x 12 mm		1/1
SSQ-6583 140 mm	SSQ-6586 160 mm	SSQ-6591 185 mm	3 x 12 mm		1/1
SSQ-6584 140 mm	SSQ-6587 160 mm	SSQ-6592 185 mm	4 x 14 mm		1/1
	SSQ-6588 160 mm	SSQ-6593 185 mm	5 x 14 mm		1/1
	SSQ-6589 160 mm	SSQ-6594 185 mm	6 x 16 mm		1/1

CASPAR  
SSQ-6582

Curva verso l'alto  
Top curved  
Aufwärtsgebogen  
Courbe vers le haut  
Curvos

150°

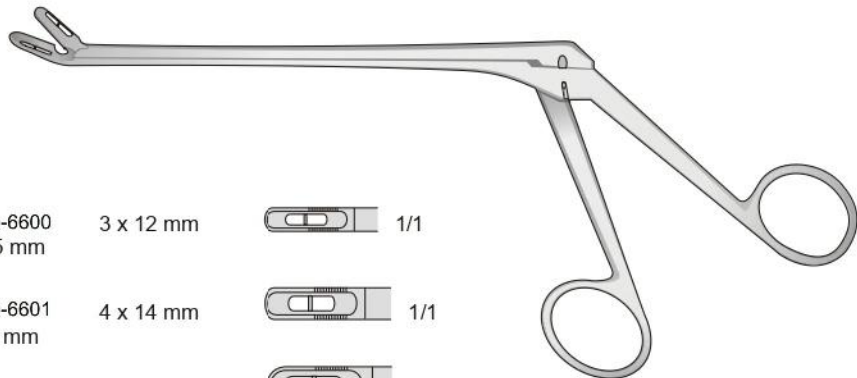

CASPAR

SSQ-6595 140 mm	SSQ-6597 160 mm	SSQ-6600 185 mm	3 x 12 mm		1/1
SSQ-6596 140 mm	SSQ-6598 160 mm	SSQ-6601 185 mm	4 x 14 mm		1/1
	SSQ-6599 160 mm	SSQ-6602 185 mm	5 x 14 mm		1/1

CASPAR  
SSQ-6595

Curva verso il basso  
Bottom curved  
Abwärts gebogen  
Courbe vers le bas  
Curvos

150°

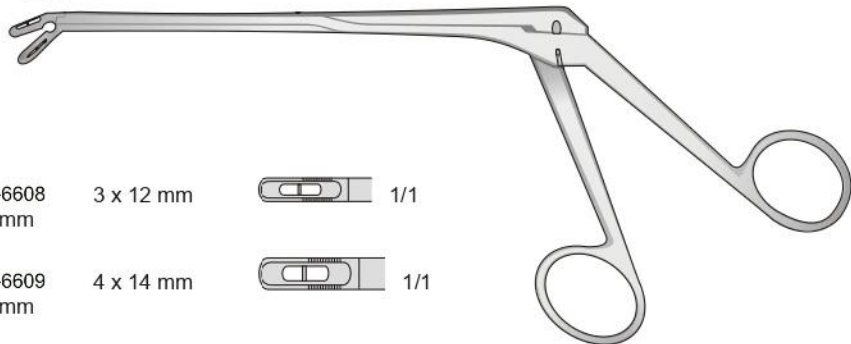

CASPAR

SSQ-6604 140 mm	SSQ-6606 160 mm	SSQ-6608 185 mm	3 x 12 mm		1/1
SSQ-6605 140 mm	SSQ-6607 160 mm	SSQ-6609 185 mm	4 x 14 mm		1/1

CASPAR  
SSQ-6603

Diritta  
Stright  
Gerade  
Droites  
Rectas

← 210 mm →

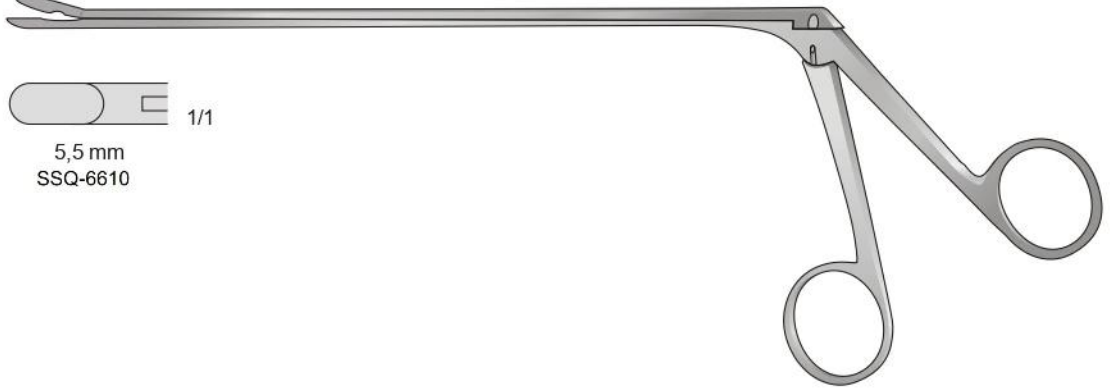

WAGNER  
SSQ-6610

Diritta  
Stright  
Gerade  
Droites  
Rectas

← 255 mm →

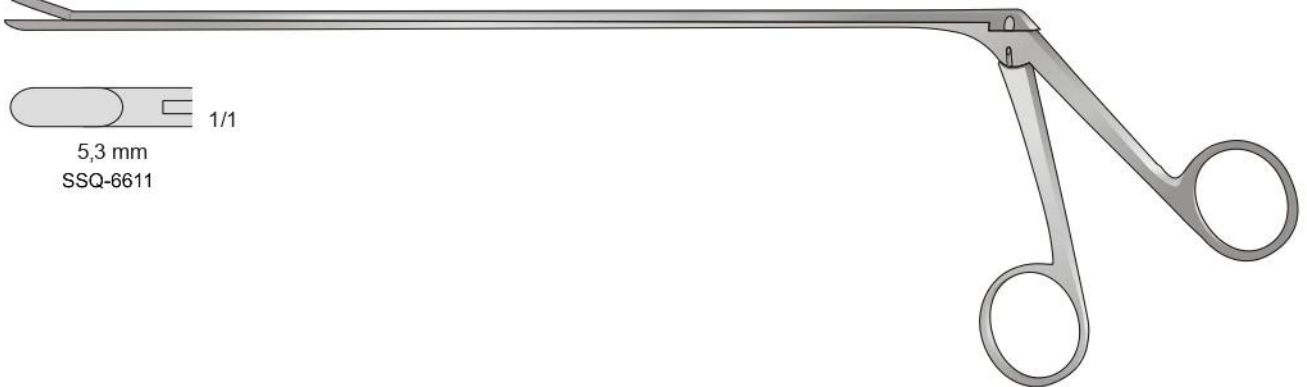
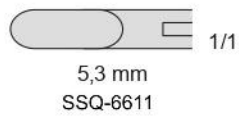

SSQ-6611

Curva verso l'alto  
Top curved  
Aufwärtsgebogen  
Courbe vers le haut  
Curvos

← 255 mm →

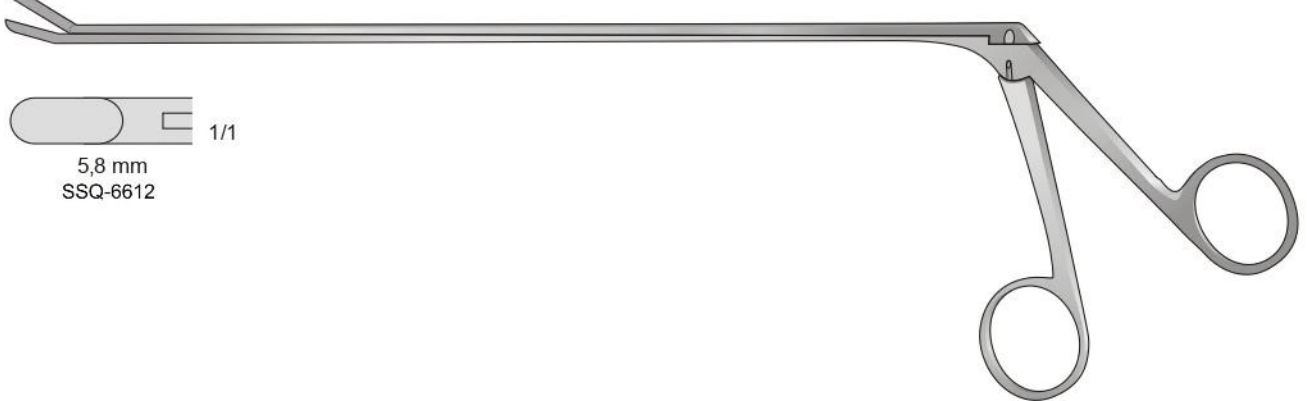

SYPERT  
SSQ-6612

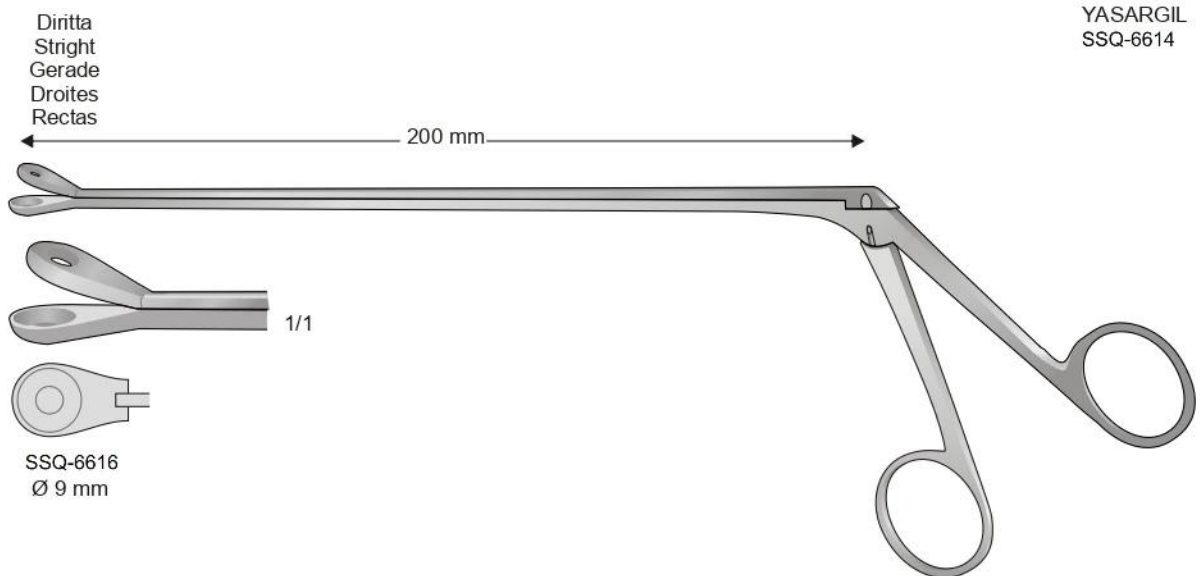
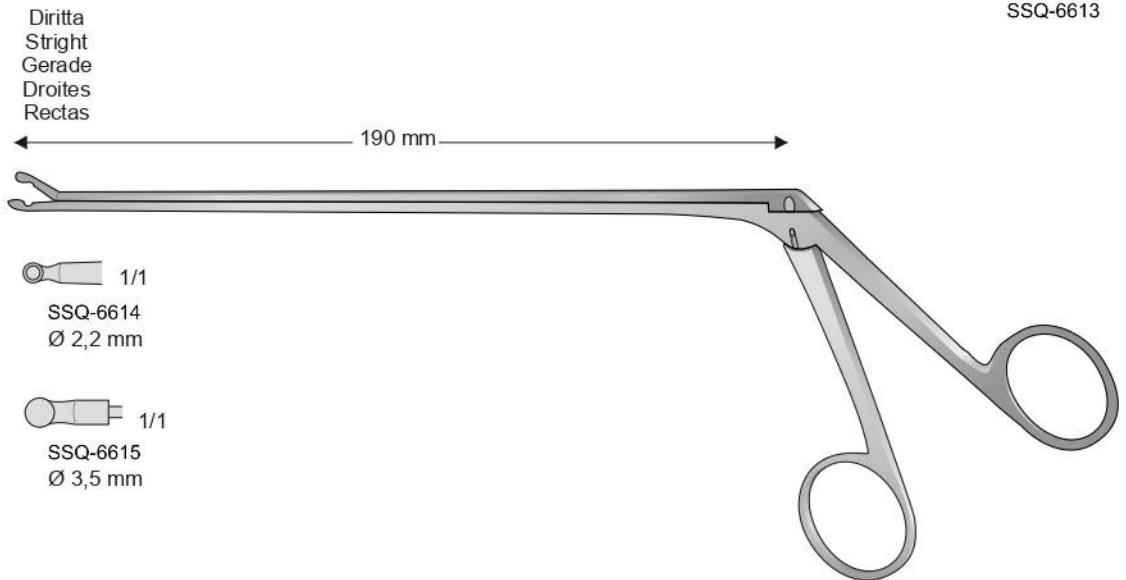
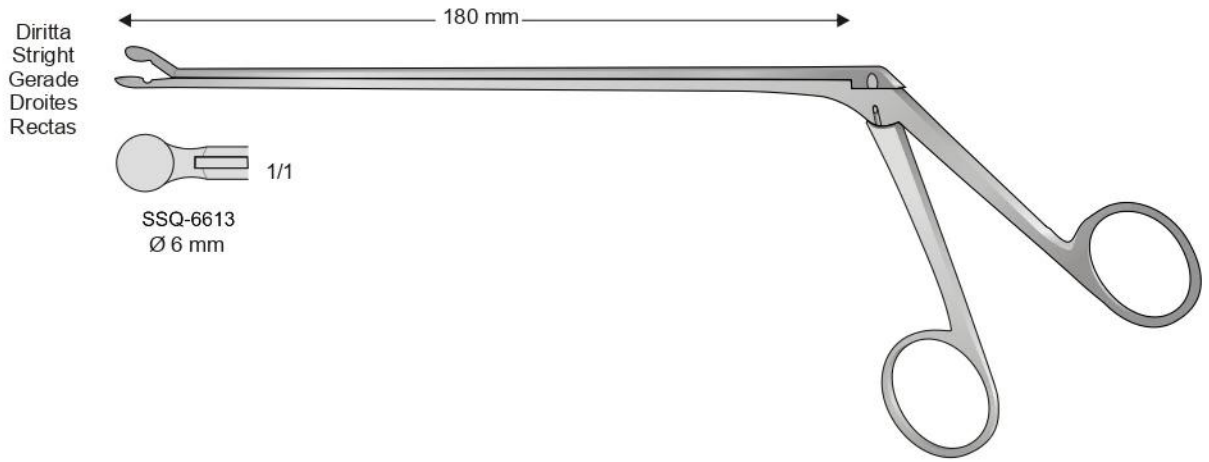

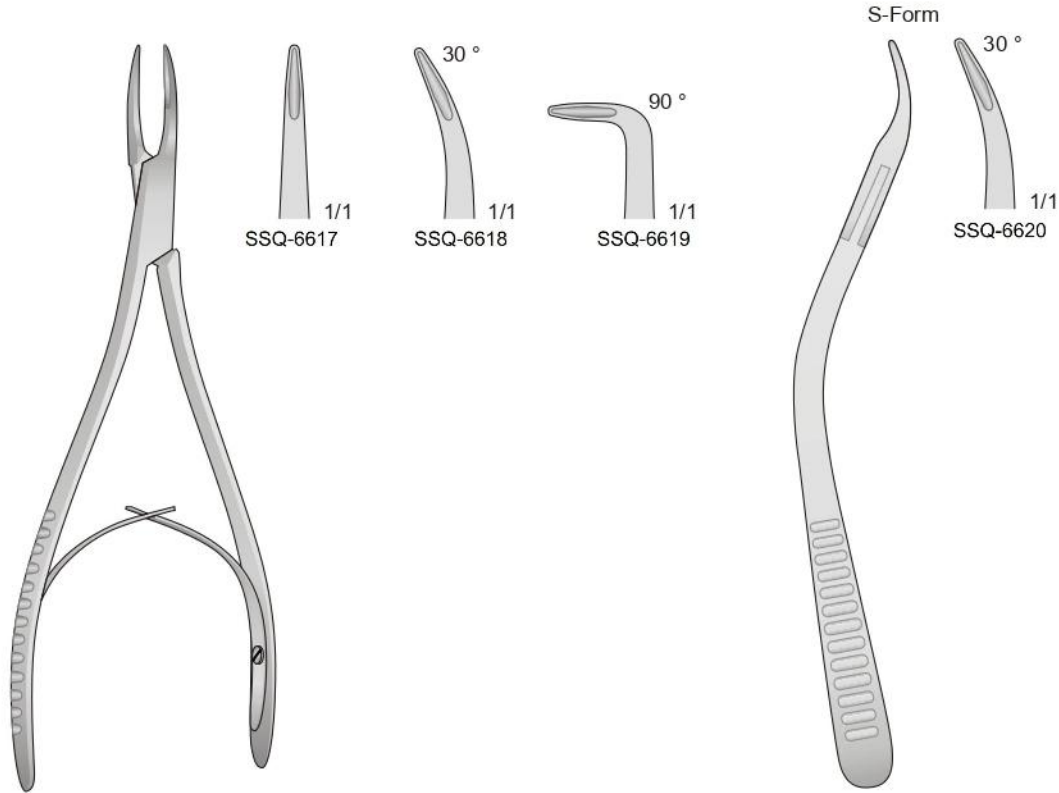

MINI-FRIEDMANN  
SSQ-6617  
150 mm

MINI-FRIEDMANN  
SSQ-6620  
145 mm

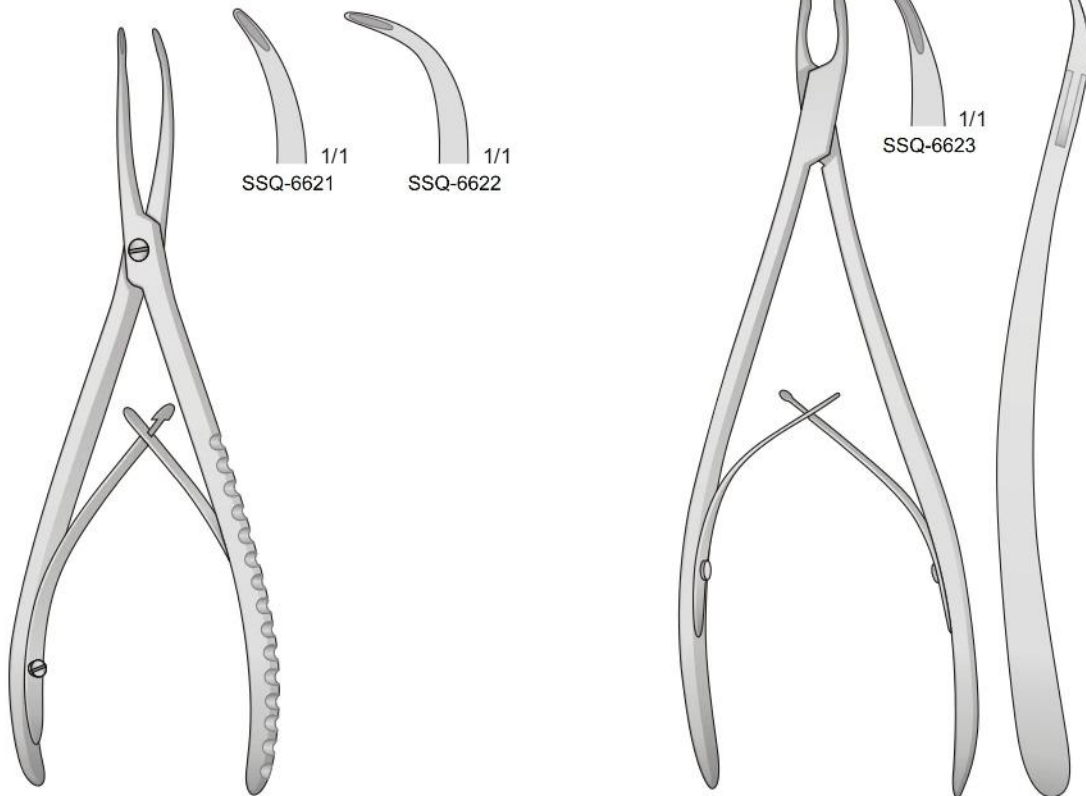

STELLBRINK  
SSQ-6621  
170 mm

STELLBRINK  
SSQ-6623  
190 mm

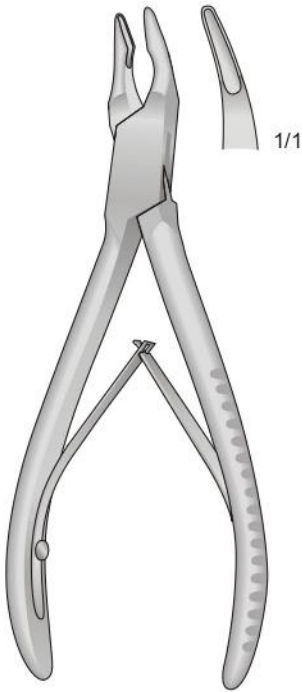

MINI FRIEDMANN  
SSQ-6624  
120 mm

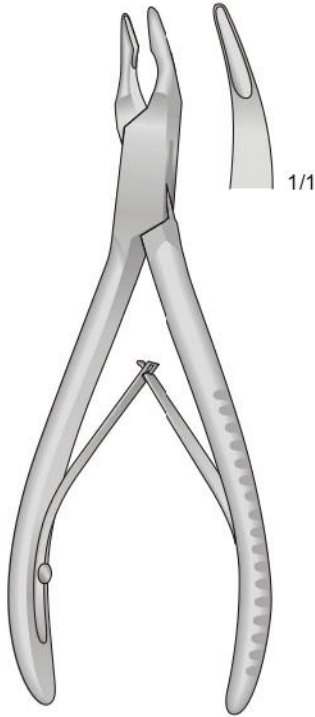

FRIEDMANN  
SSQ-6625  
140 mm

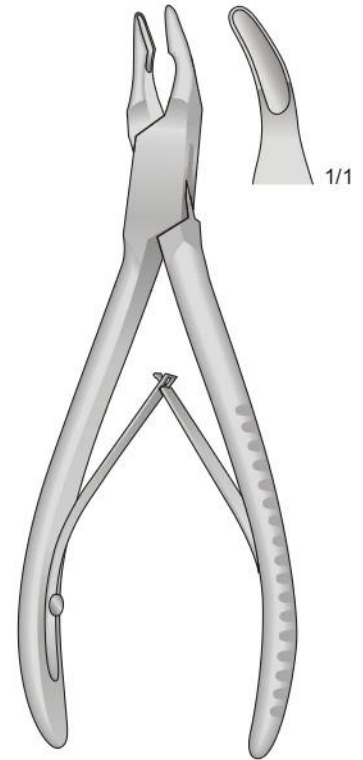

BLUMENTHAL  
SSQ-6626  
155 mm

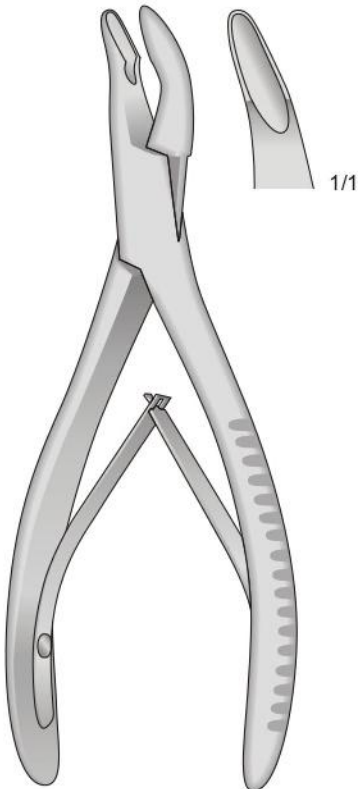

MEAD  
SSQ-6627  
165 mm

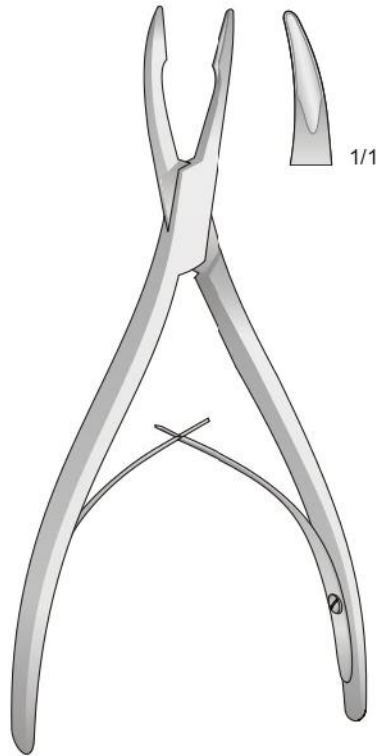

FRIEDMANN  
SSQ-6628  
160 mm

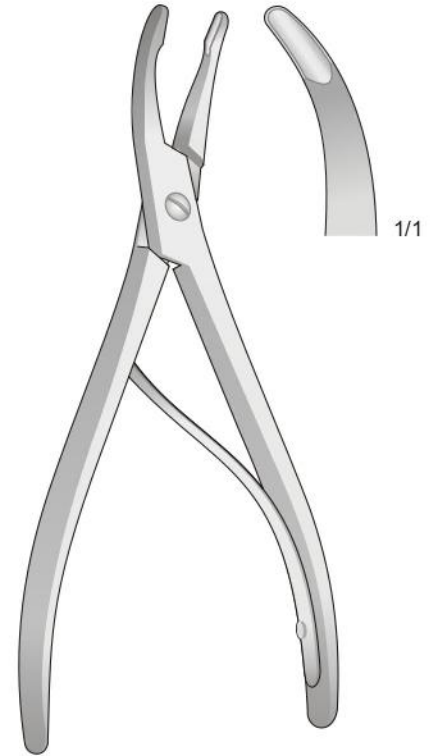

LUER  
SSQ-6629  
155 mm



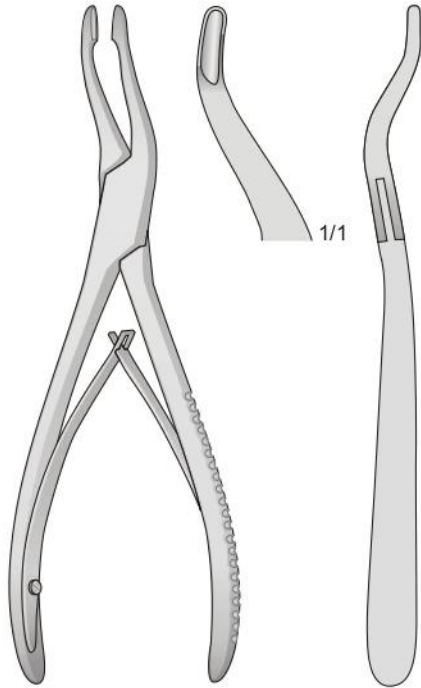

ALEXANDER  
SSQ-6630  
140 mm

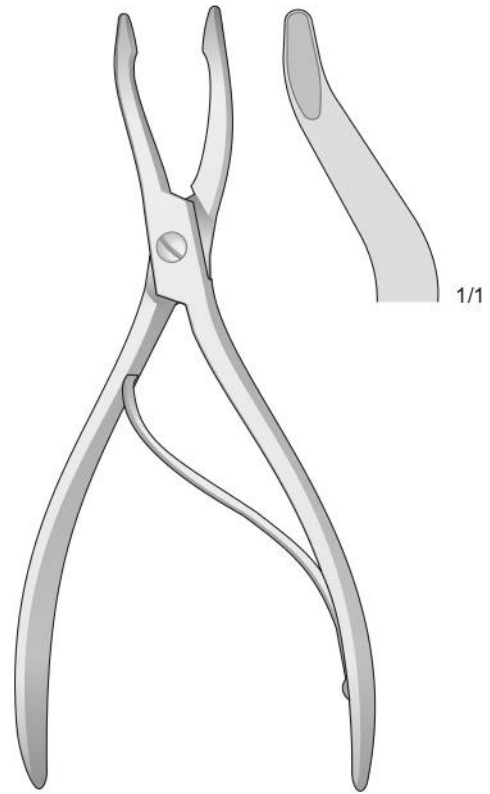

JANSEN-LEUER  
SSQ-6631  
180 mm

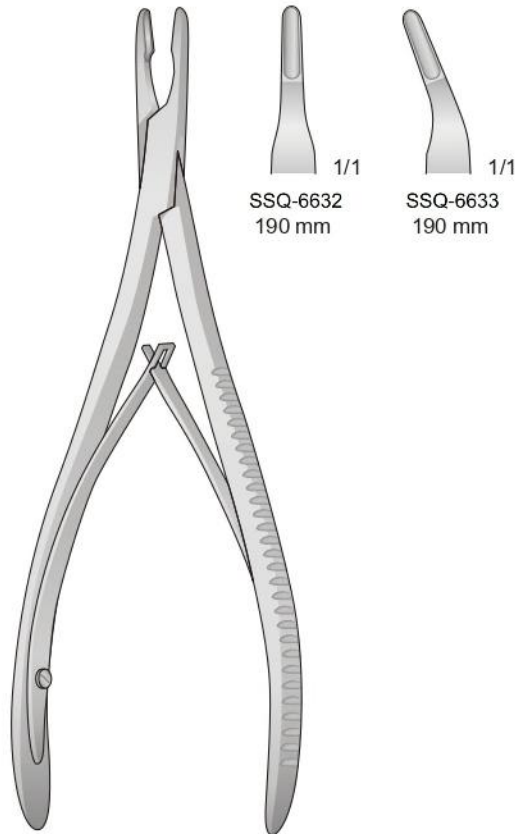

LEMPERT  
SSQ-6632  
190 mm

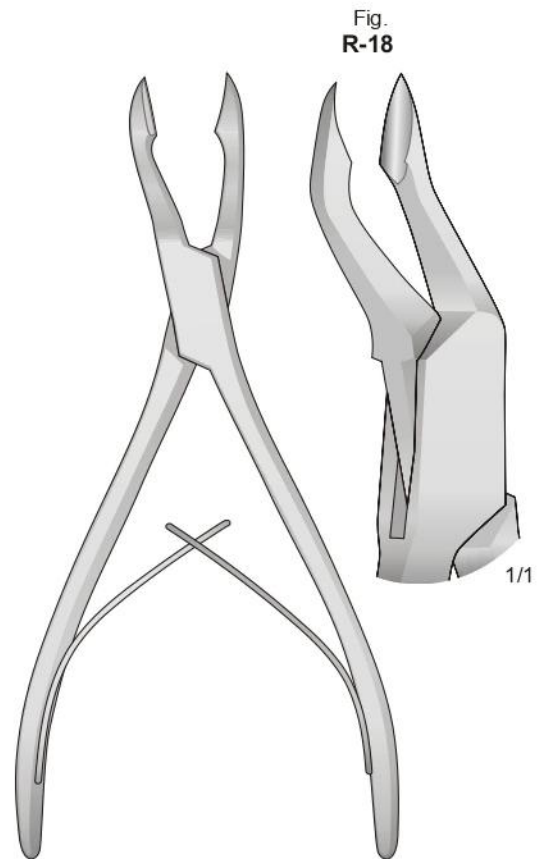

SSQ-6634  
175 mm

Fig.  
R-18

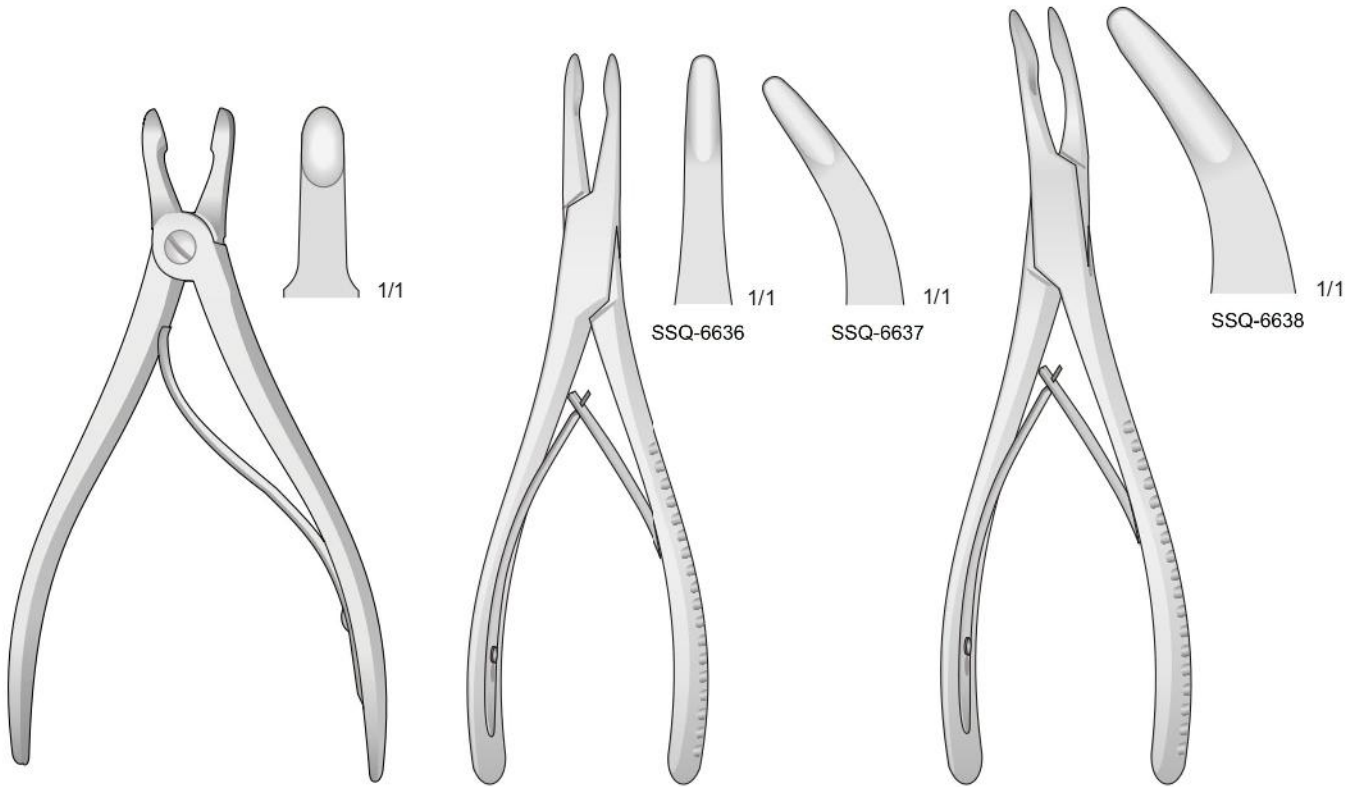

HARTMANN  
SSQ-6635  
155 mm

JANSEN  
SSQ-6636  
170 mm

OLIVECRONA  
SSQ-6638  
190 mm

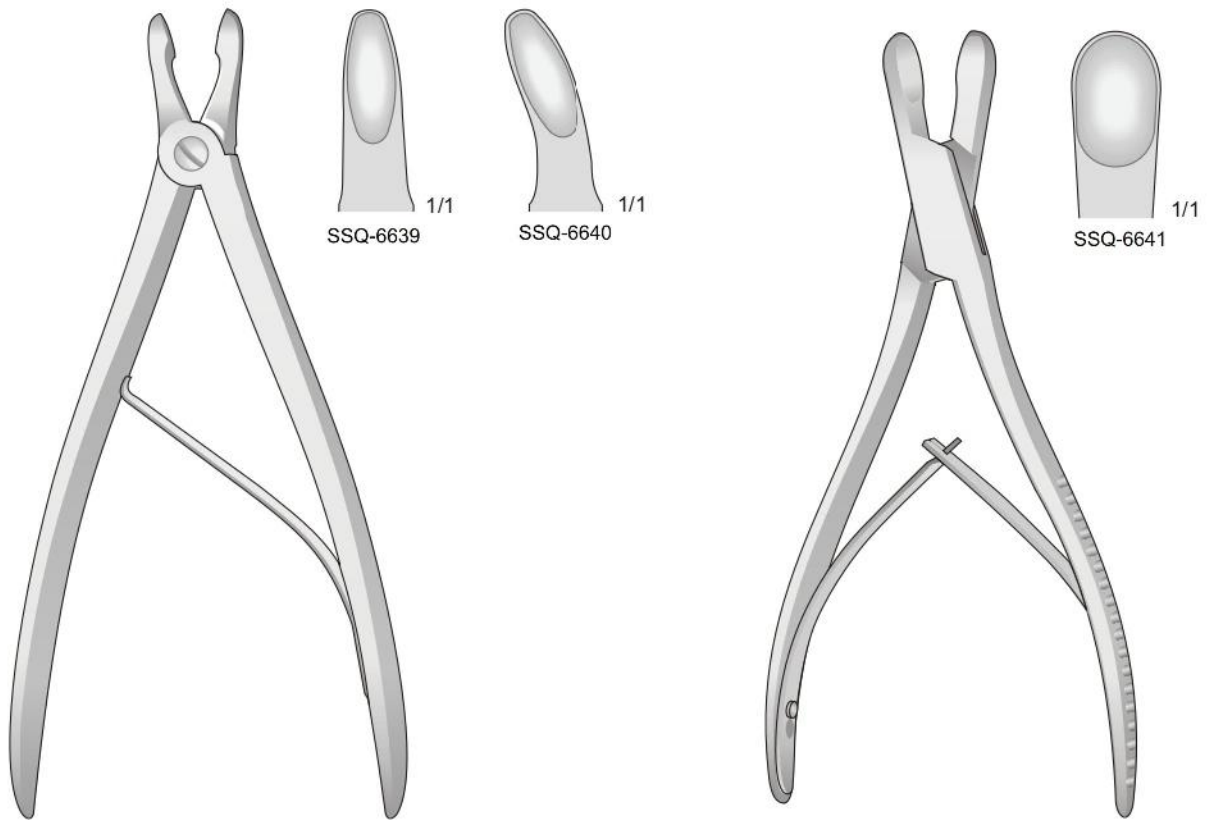

CUSHING  
SSQ-6639  
190 mm

LUER-STILLE  
SSQ-6641  
185 mm

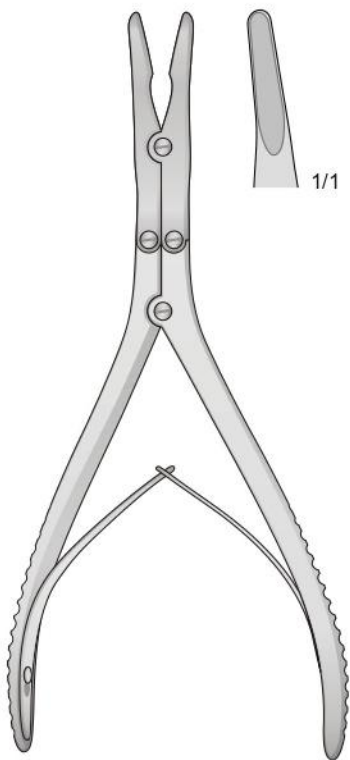

BEYER  
SSQ-6642  
180 mm

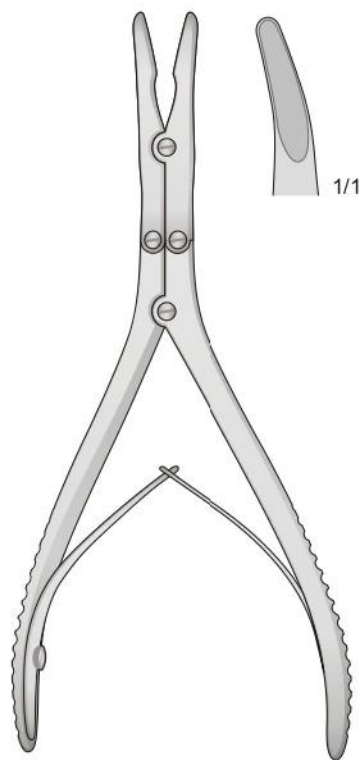

ZAUFAL-JANSEN  
SSQ-6643  
180 mm

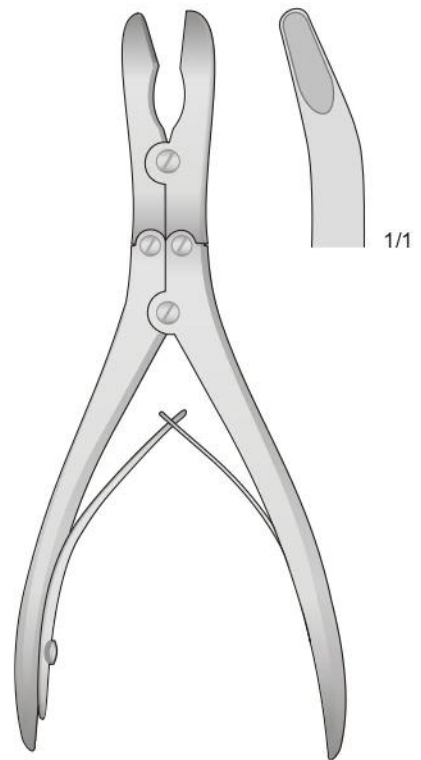

RUSKIN-STILLE  
SSQ-6644  
180 mm

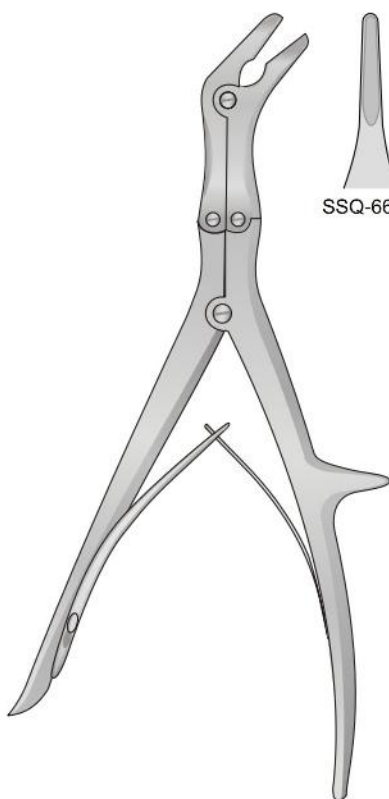

ECHLIN  
SSQ-6645  
230 mm

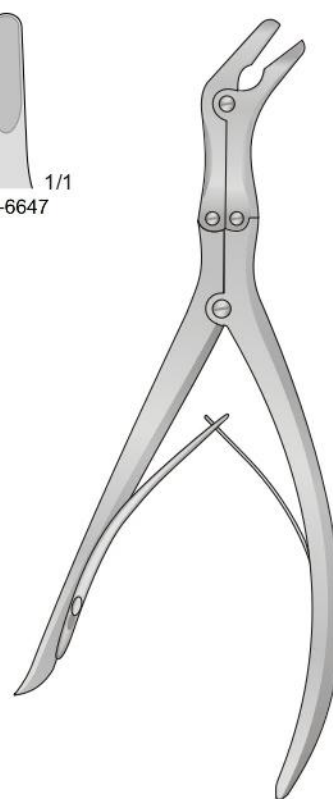
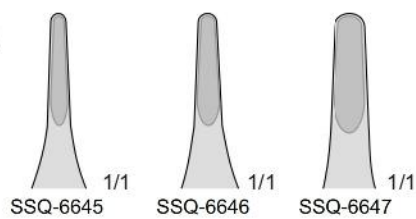

LEKSELL  
SSQ-6648

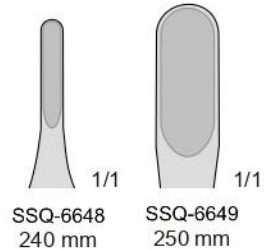

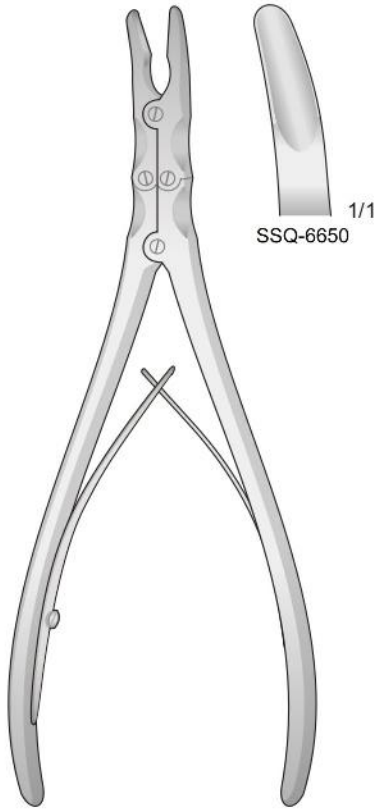

RÖTTGEN-RUSKIN  
SSQ-6650  
240 mm

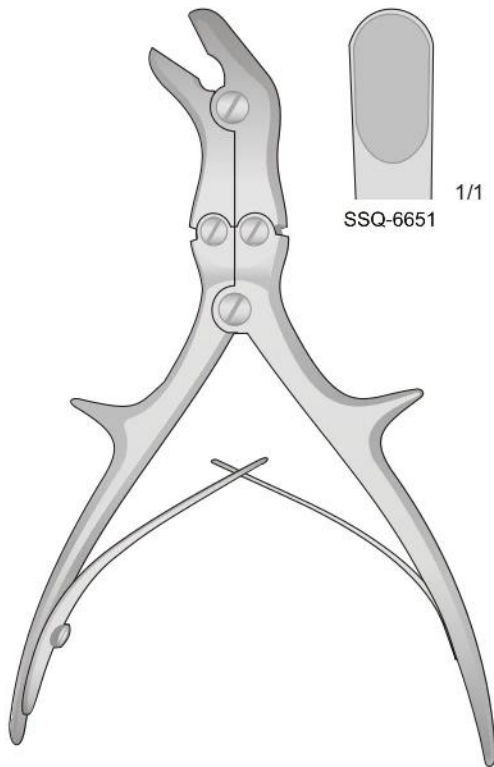

STILLE  
SSQ-6651  
210 mm

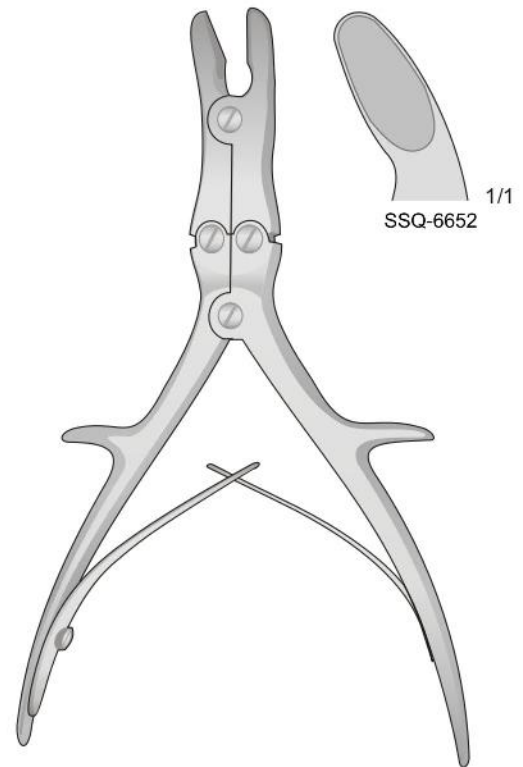

LUER-STILLE  
SSQ-6652  
210 mm

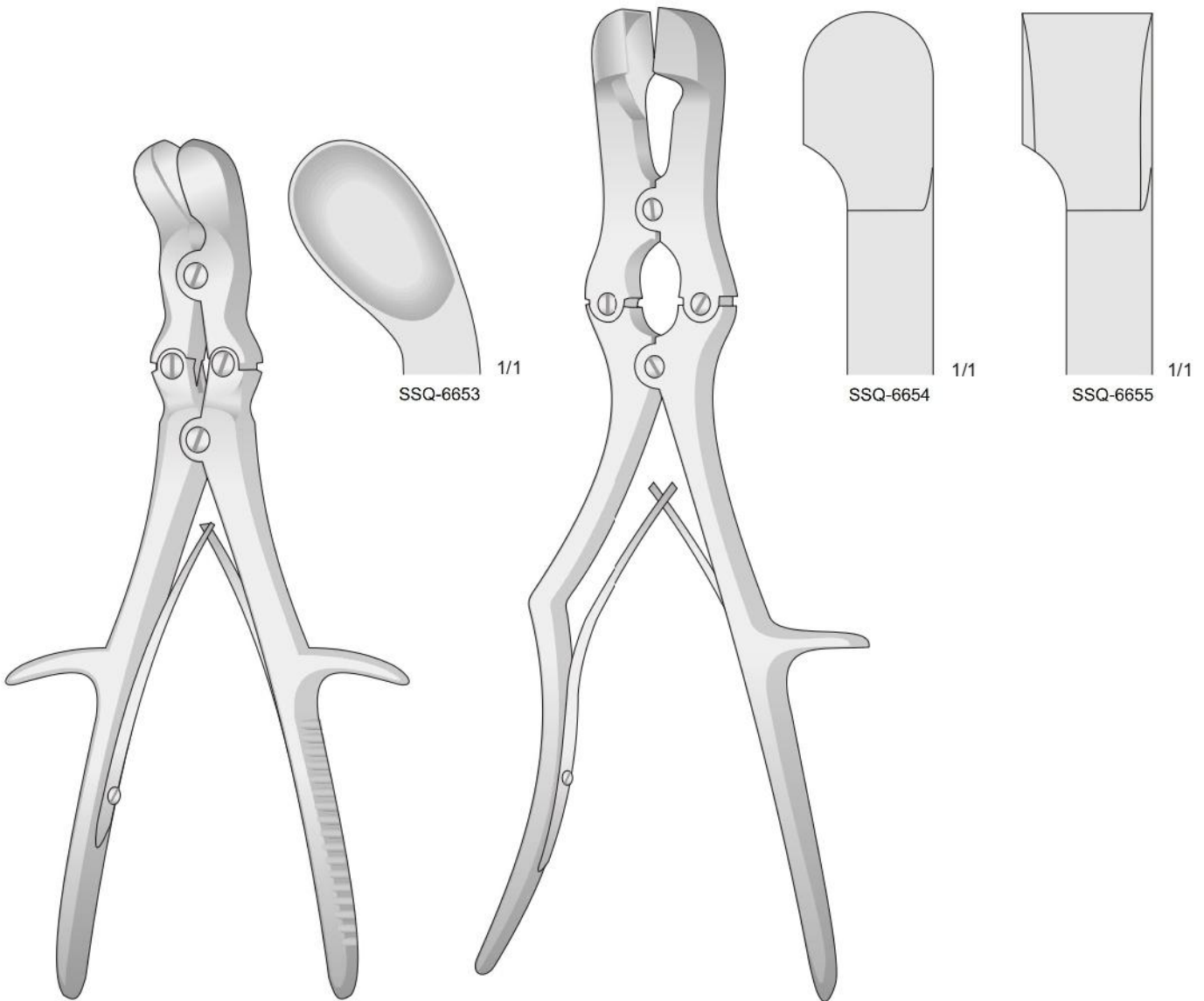

LUER-STILLE  
SSQ-6653  
260 mm

SAUERBRUCH  
SSQ-6654  
300 mm

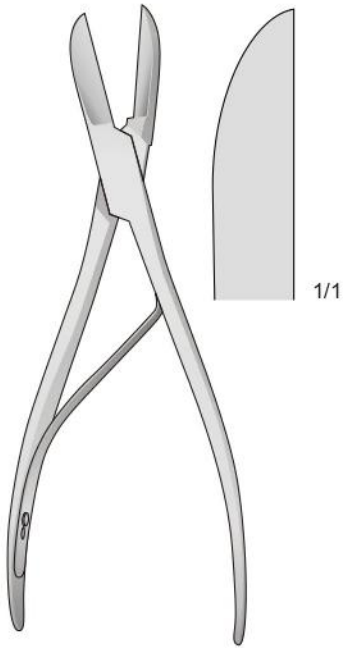

LISTON  
SSQ-6656  
220 mm

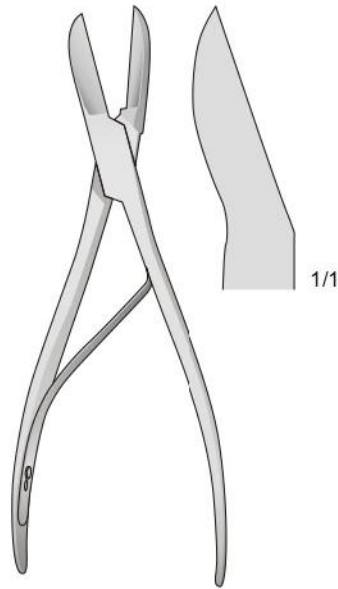

LISTON  
SSQ-6657  
170 mm

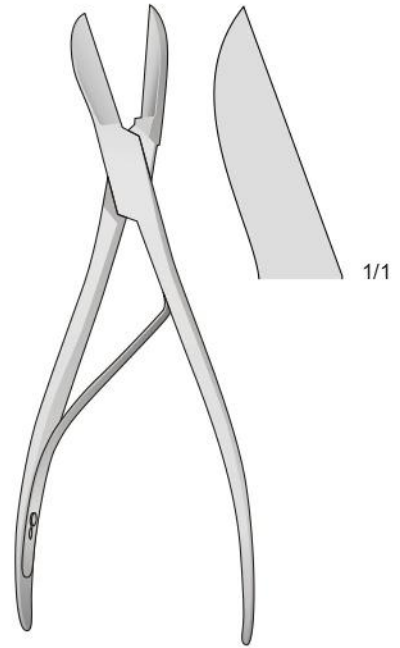

LISTON  
SSQ-6658  
220 mm

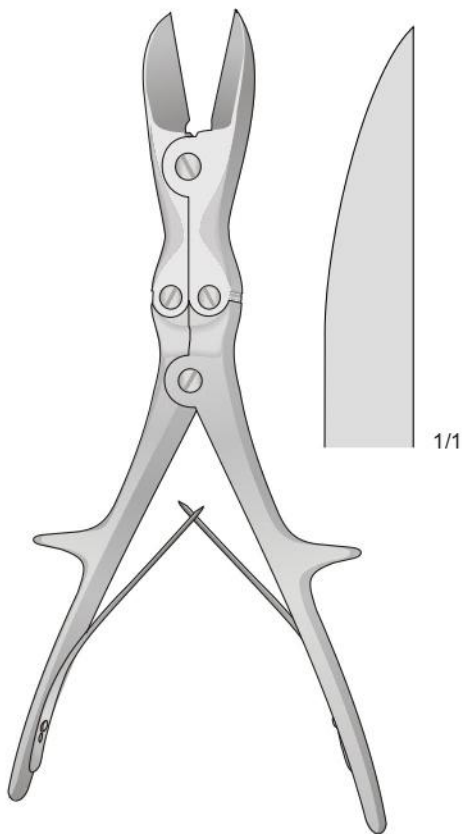

LISTON  
SSQ-6659  
270 mm

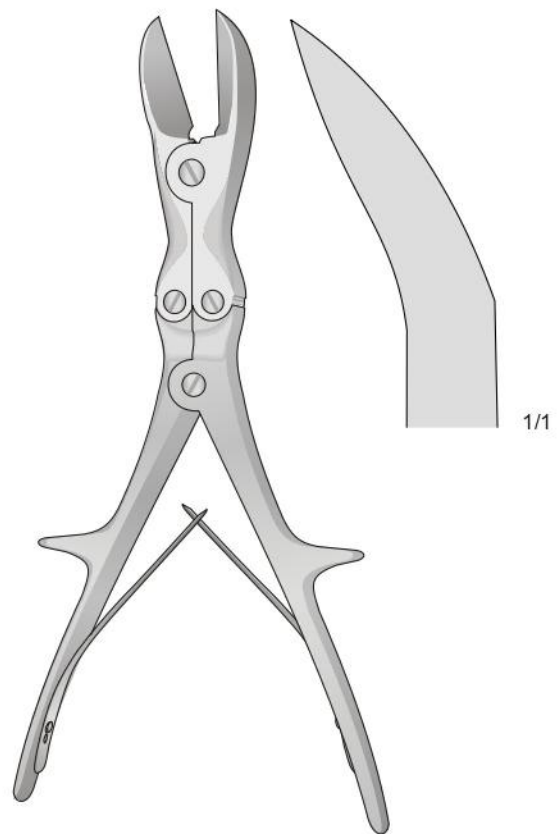

LISTON  
SSQ-6660  
270 mm

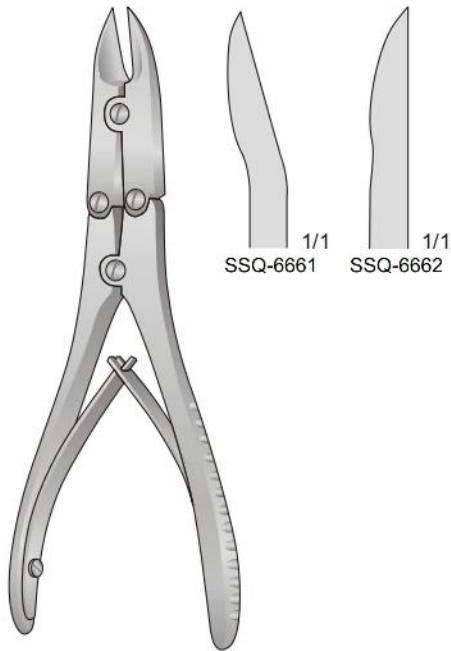

**BÖHLER**  
SSQ-6661  
150 mm

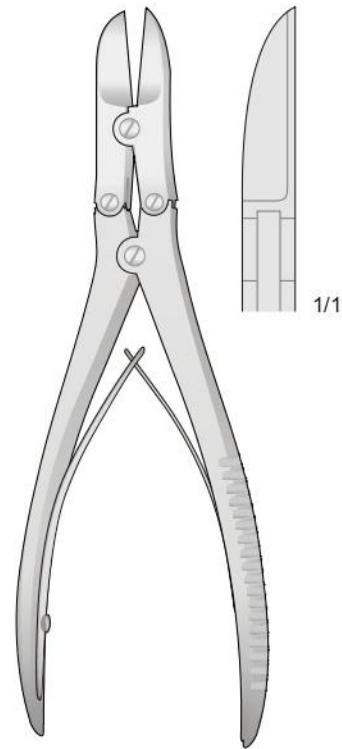

**RUSKIN-LISTON**  
SSQ-6663  
190 mm

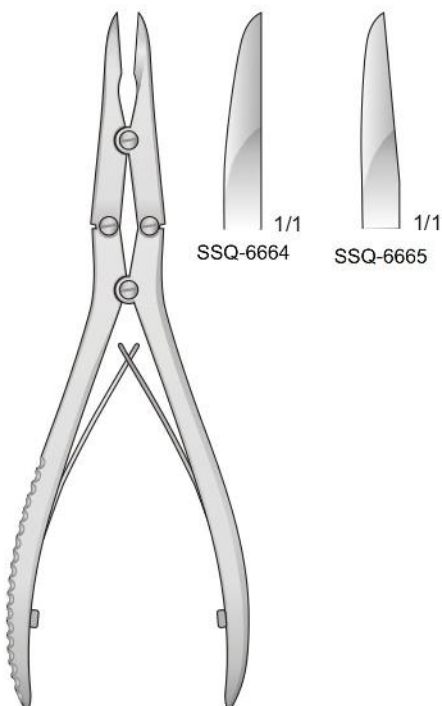

**SSQ-6664**  
180 mm

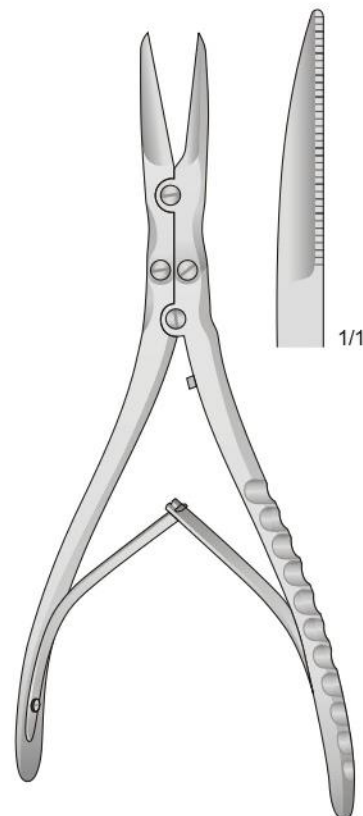

**SSQ-6666**  
215 mm

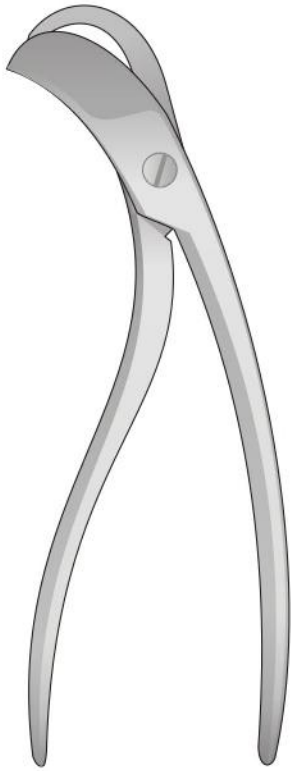

COLLIN  
SSQ-6667  
195 mm

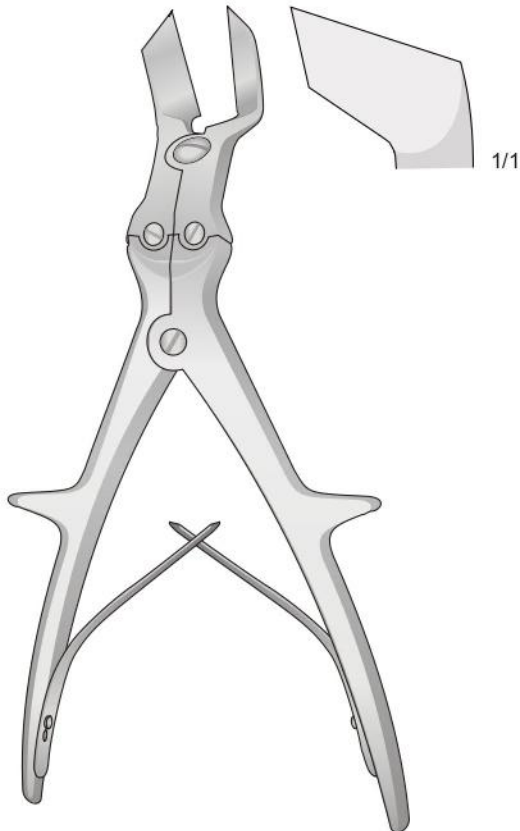

KEY-HORSLEY  
SSQ-6668  
235 mm

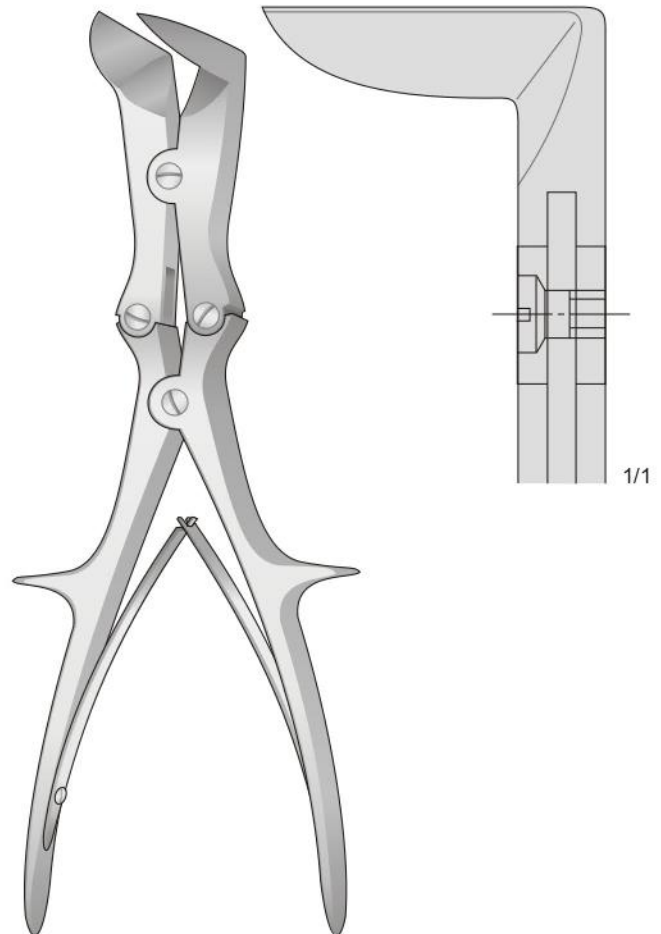

LISTON-STILLE  
SSQ-6669  
265 mm



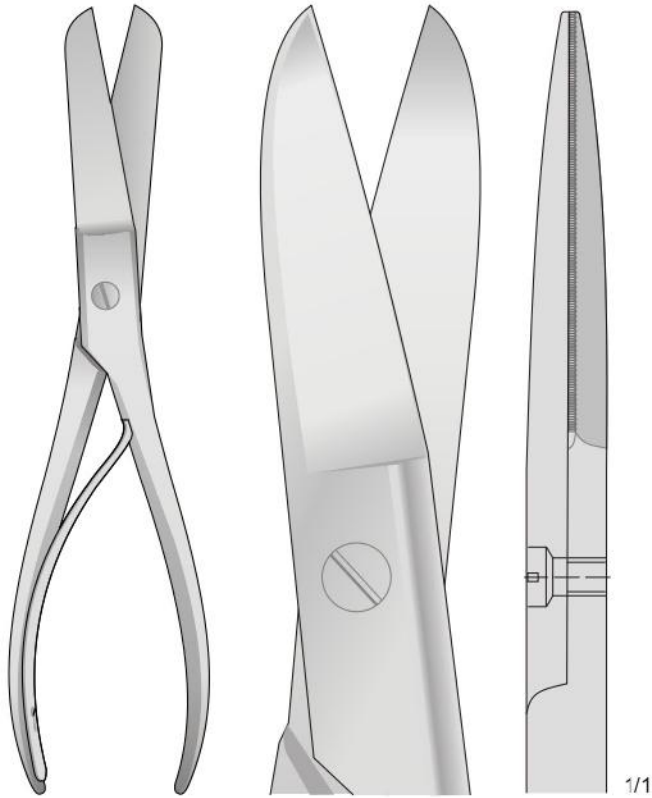

SSQ-6670  
230 mm

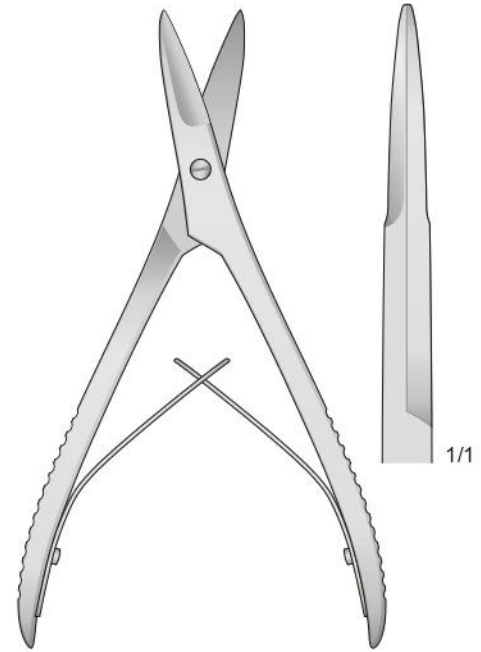

SSQ-6671  
160 mm

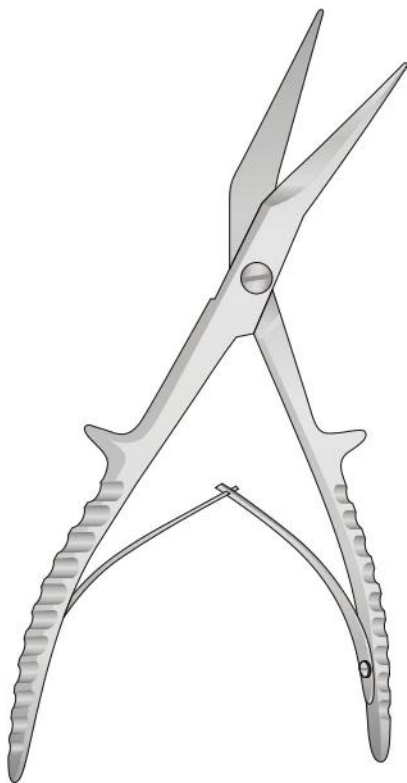

SSQ-6672  
195 mm

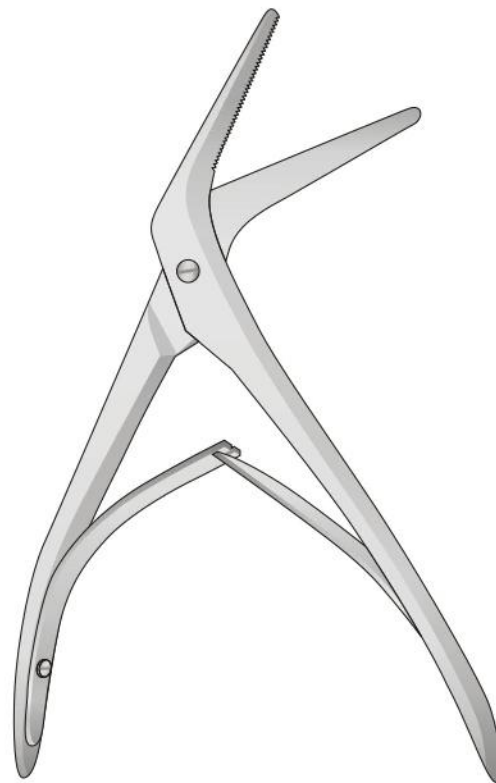

JACKSON-TESSIER  
SSQ-6673  
190 mm

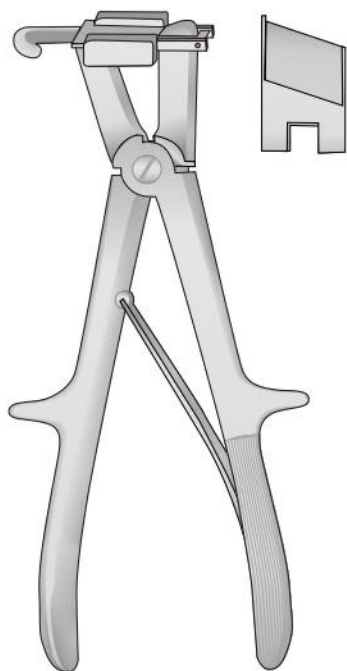

SAUERBRUCH  
SSQ-6674 - 230 mm  
SSQ-6675 - 260 mm



SCHUMACHER  
SSQ-6676  
210 mm

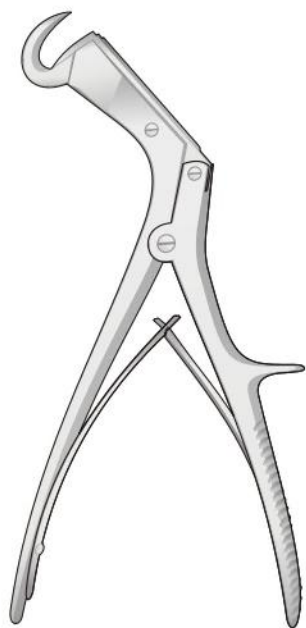

GIERTZ-STILLE  
SSQ-6677  
250 mm

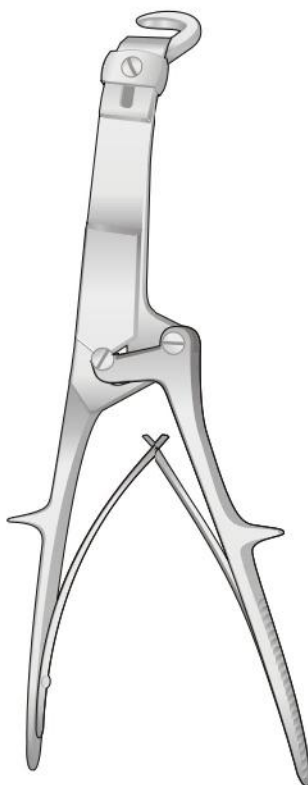

BRUNNER  
SSQ-6678 - Destro  
SSQ-6679 - Sinistro  
320 mm

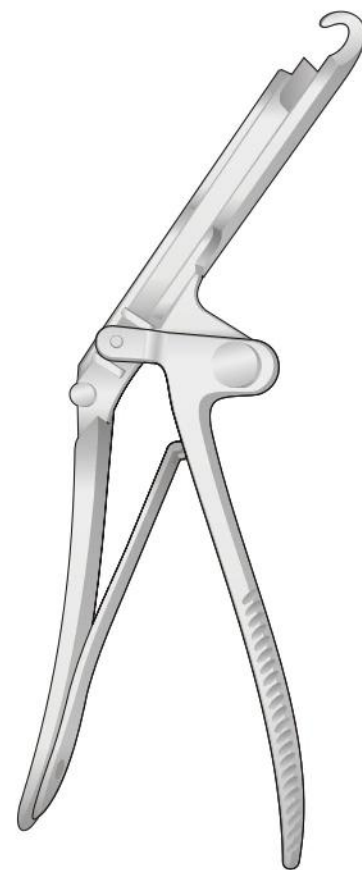

SAUERBRUCH-FREY  
SSQ-6680  
370 mm

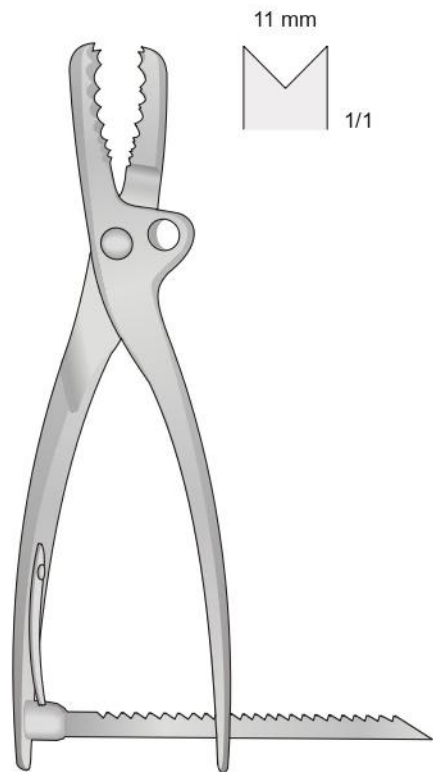

FARABEU-F-LAMBOTTE  
SSQ-6681  
250 mm



FARABEU  
SSQ-6682

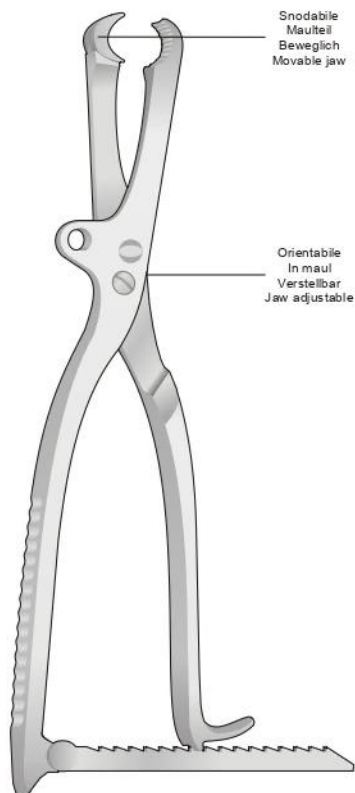

LAMBOTTE  
SSQ-6685  
265 mm

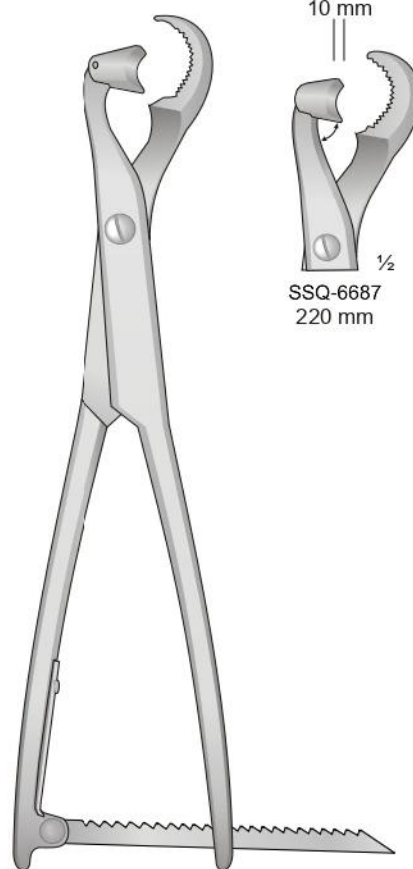

LAMBOTTE  
SSQ-6686  
330 mm

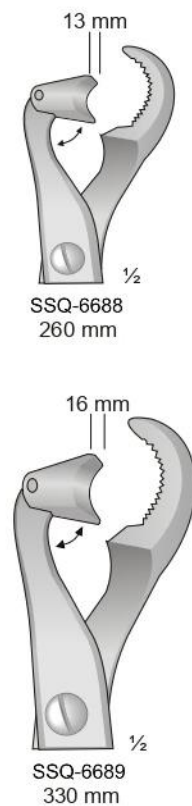

SSQ-6688  
260 mm

SSQ-6689  
330 mm

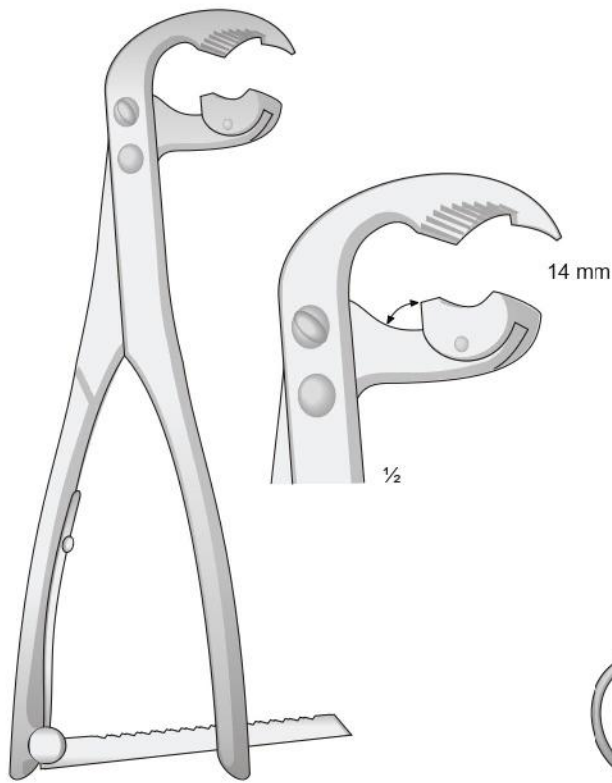

SSQ-6690  
215 mm

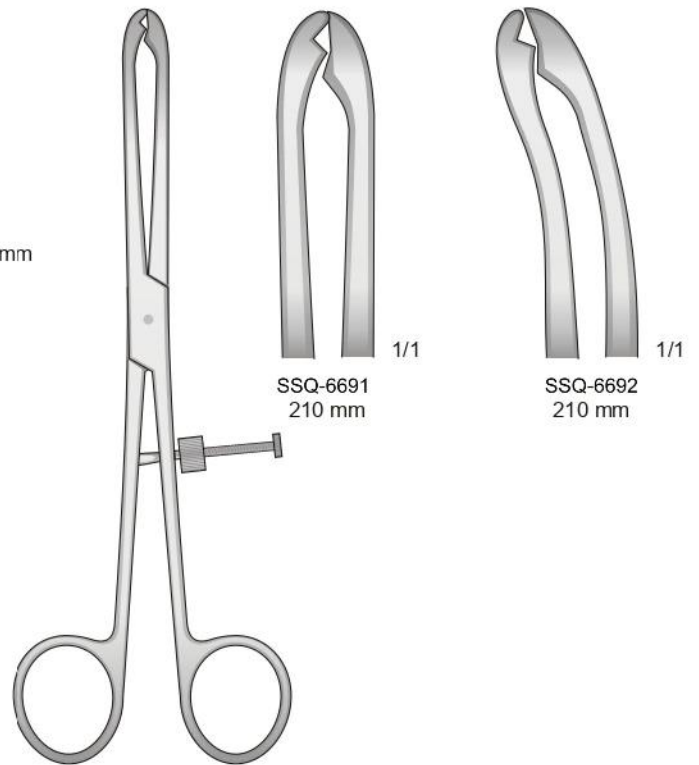

SSQ-6691  
210 mm

SSQ-6692  
210 mm

FIBULA  
12-980  
210 mm

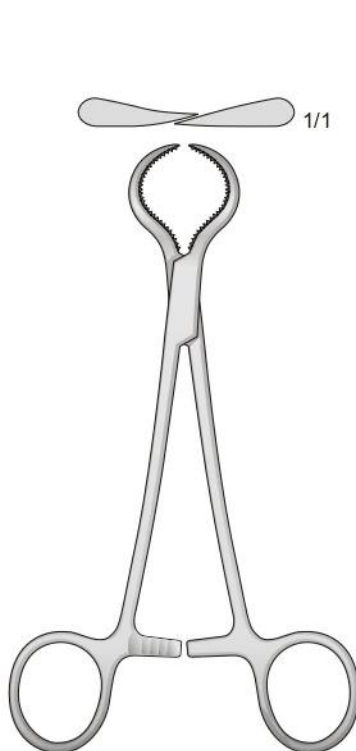

LEWIN  
SSQ-6693  
180 mm

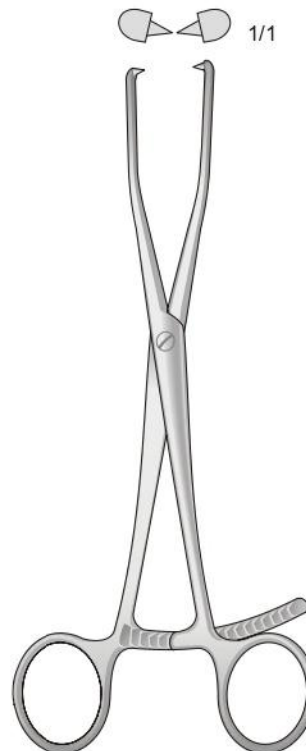

SSQ-6694  
210 mm

Pinze riposizionatrici di osso - Repositionszangen  
Reposition forceps - Pinzas para la reducción de dedos

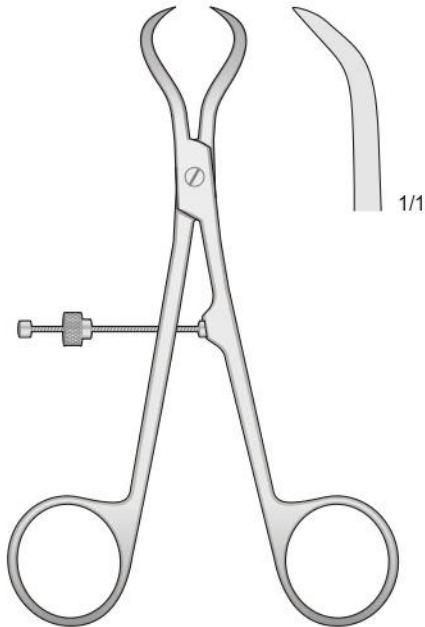

SSQ-6695  
140 mm

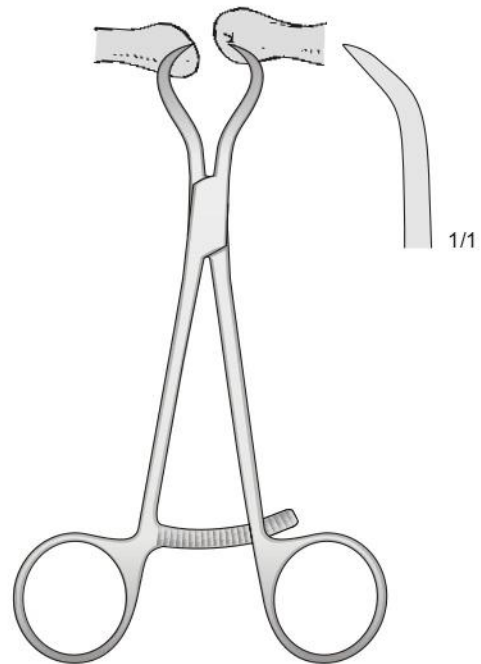

SSQ-6696  
135 mm

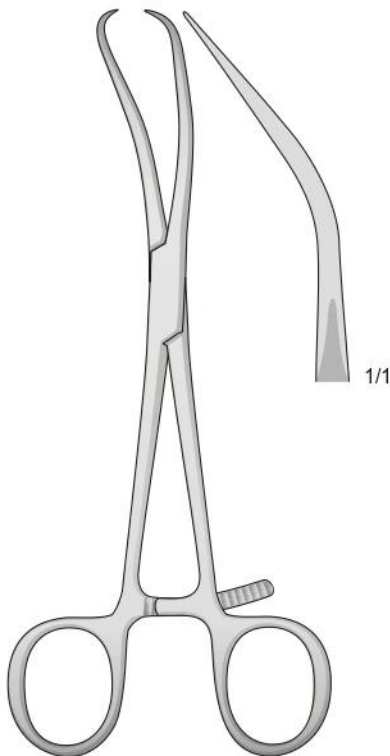

REILL  
SSQ-6697  
170 mm

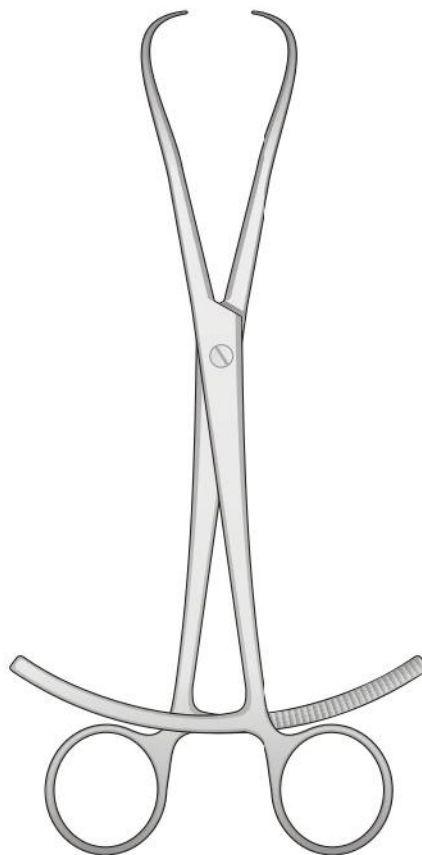

SSQ-6698  
200 mm

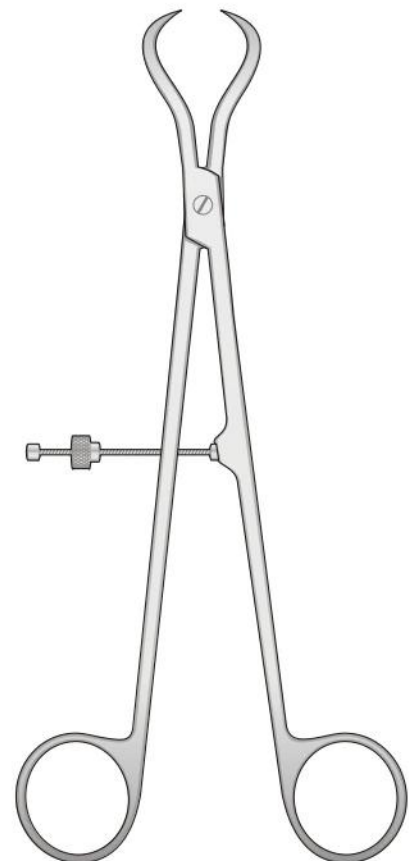

SSQ-6699  
210 mm

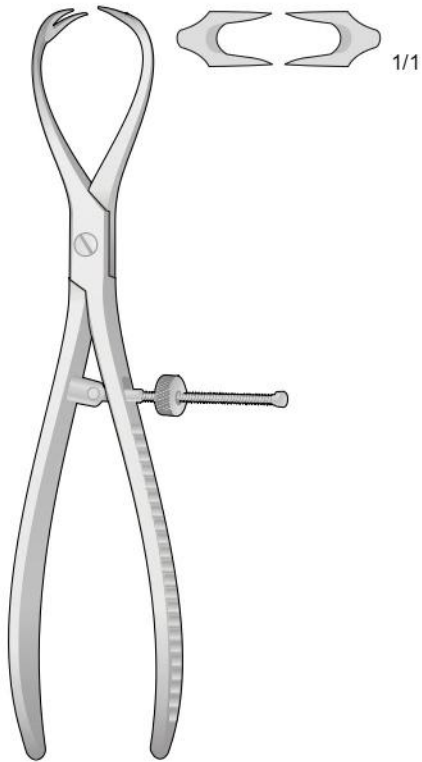

PATELLA  
SSQ-6700  
185 mm

Pinza con regolazione  
Forceps with thread fixation

Pinza con cremagliera  
Forceps with ratchet fixation

Pinza con regolazione  
Forceps with thread fixation



SSQ-6701  
140 mm

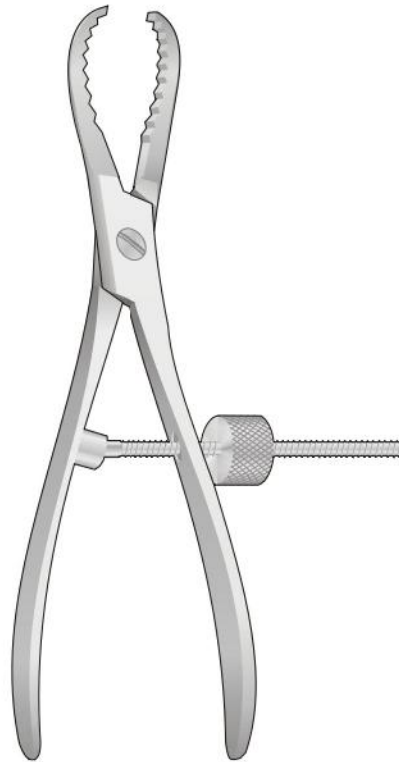

SSQ-6702  
170 mm

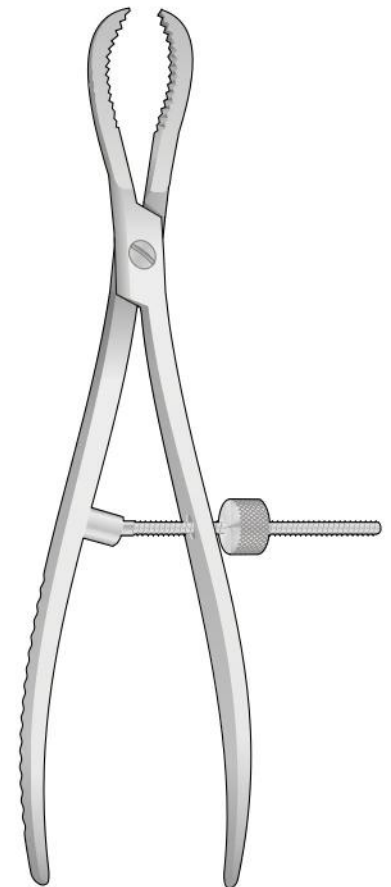

SSQ-6703  
235 mm

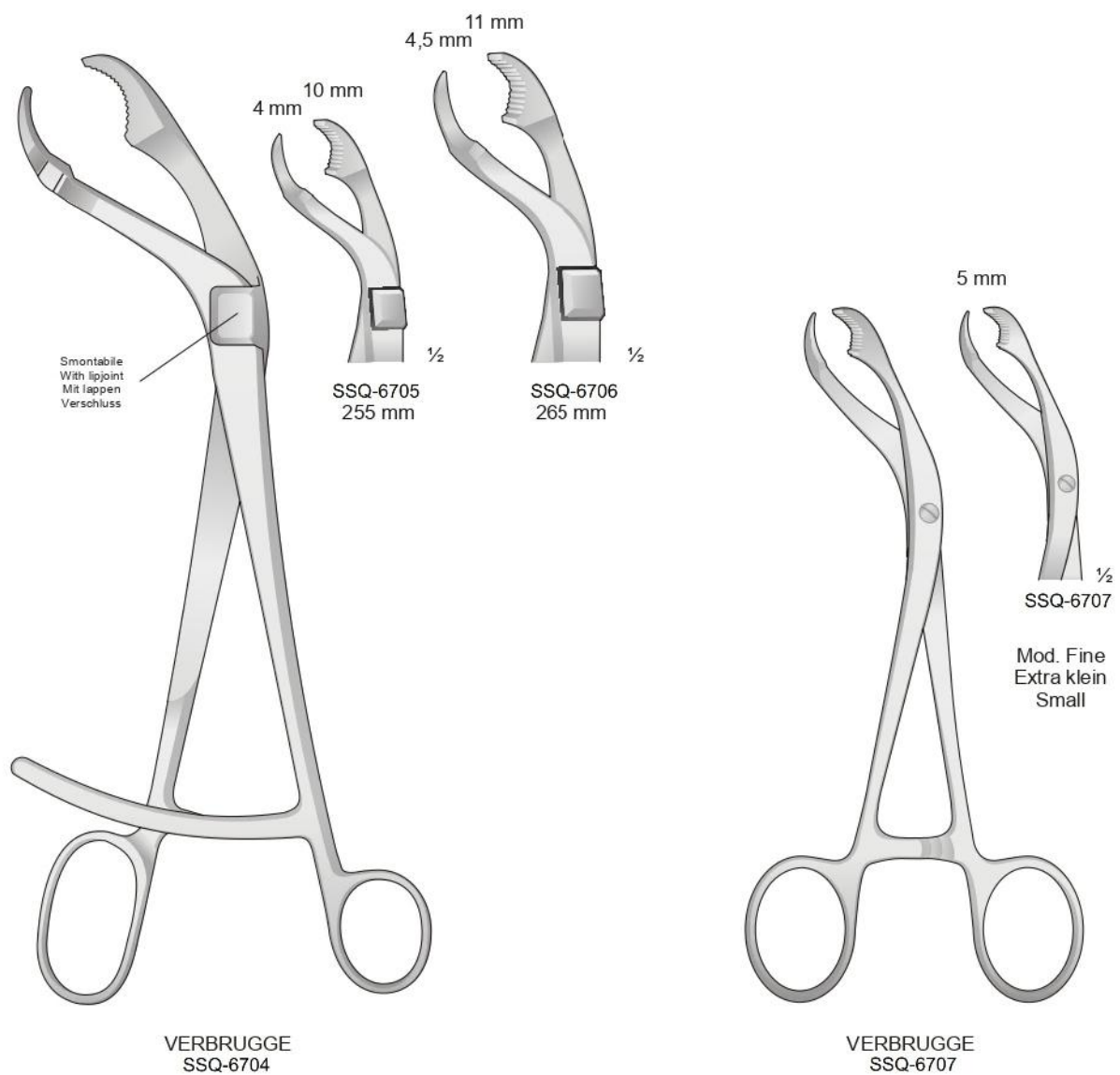

Autocentrante con blocco  
Selbstzentrierend mit gewindesperre  
Self-centering bone holding forceps with thread lock

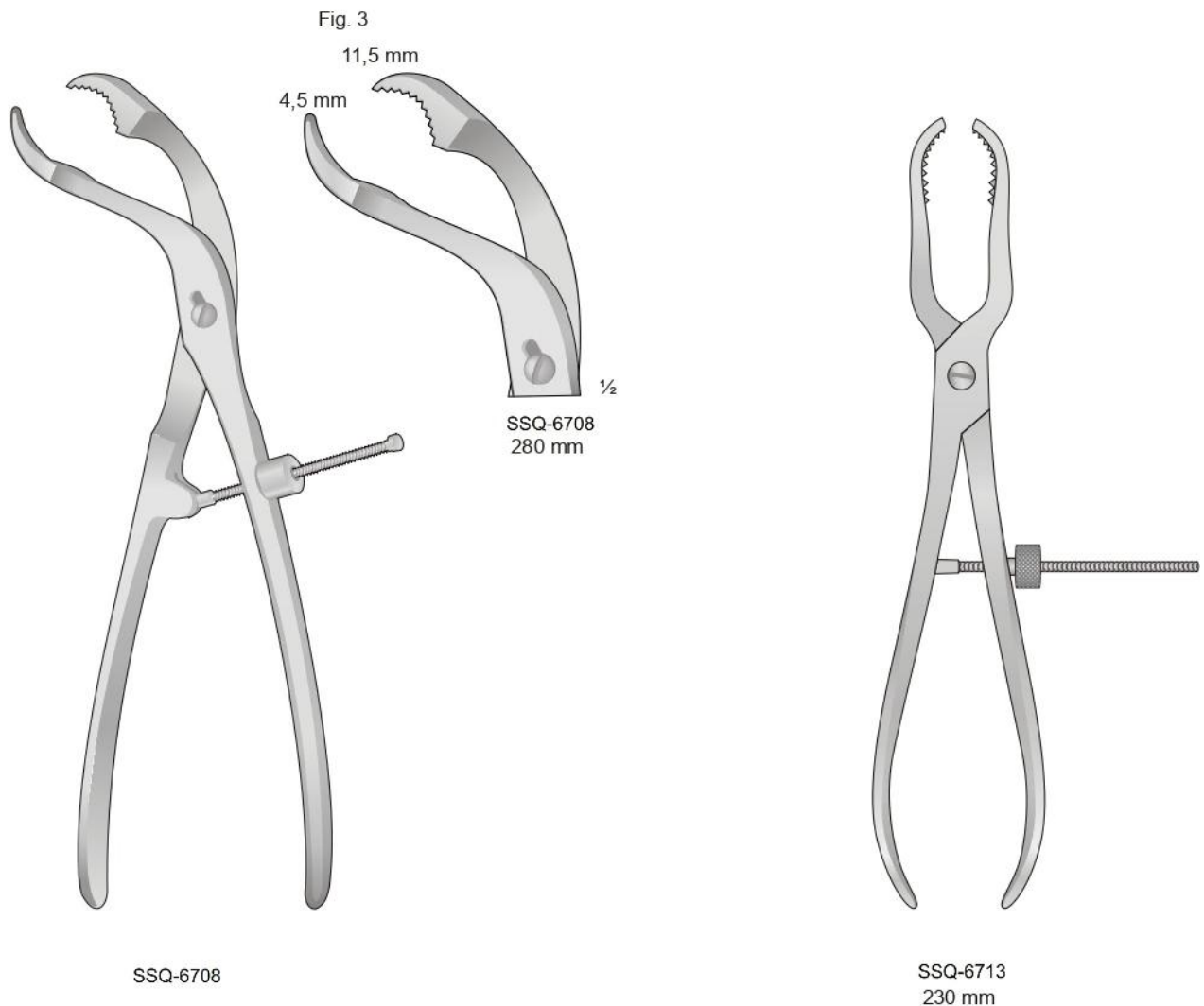
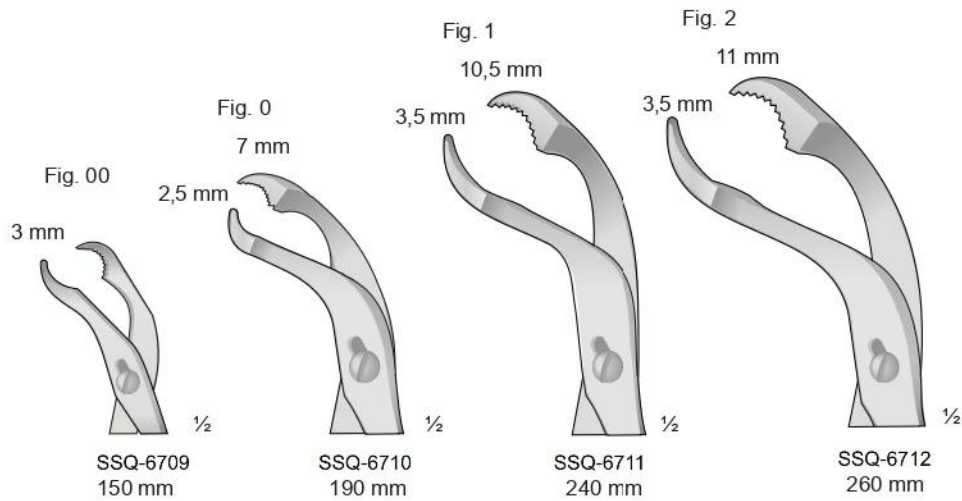



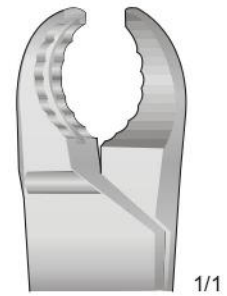

SSQ-6715  
230 mm

1/1



SSQ-6716  
250 mm

1/1

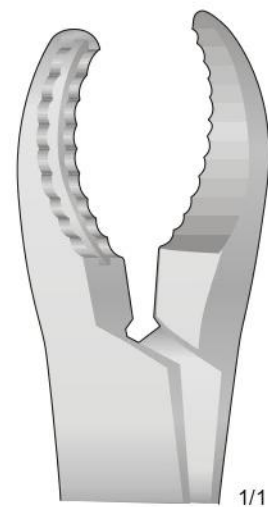

SSQ-6717  
280 mm

1/1

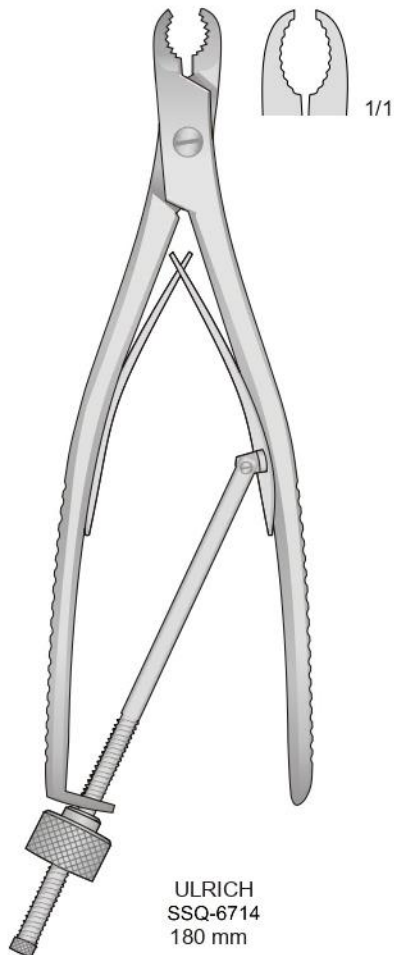

ULRICH  
SSQ-6714  
180 mm

1/1

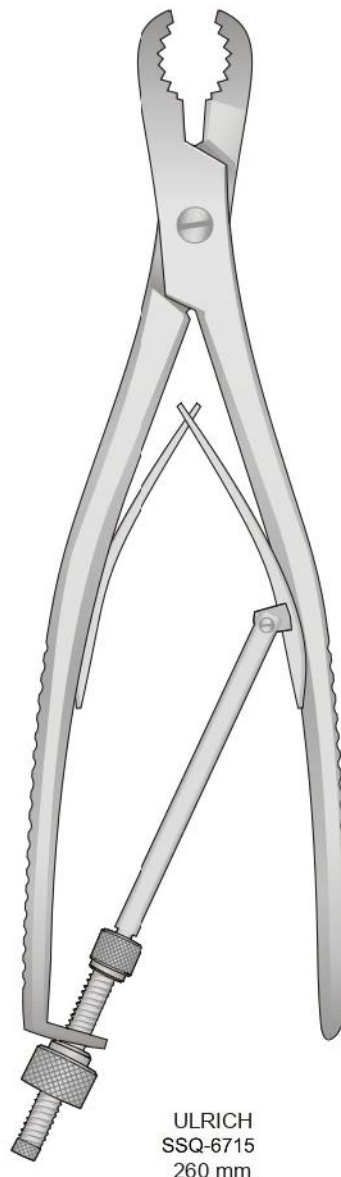

ULRICH  
SSQ-6715  
260 mm

Pinza per cartilagine

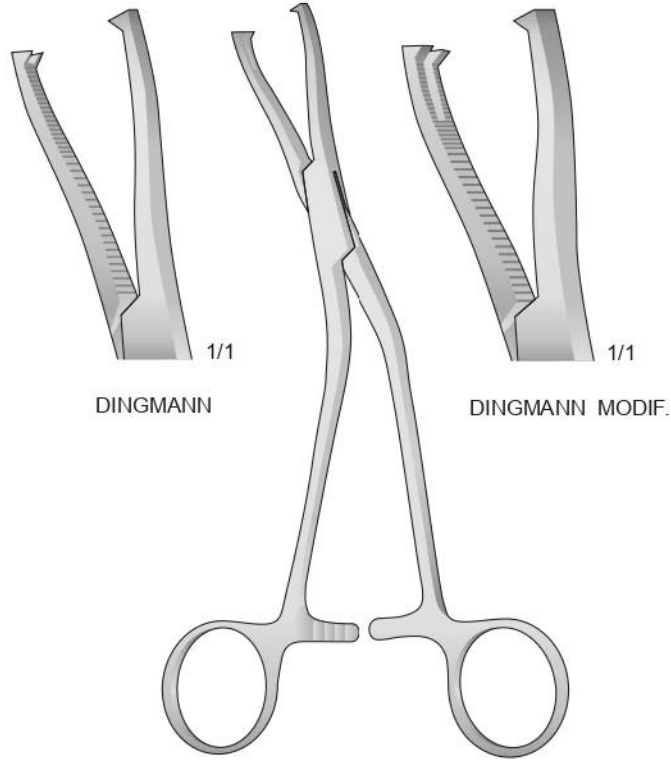

DINGMANN  
1/1

DINGMANN MODIF.  
1/1

DINGMANN  
12-1140  
190 mm



SSQ-6719  
185 mm

MARTIN  
SSQ-6720  
200 mm

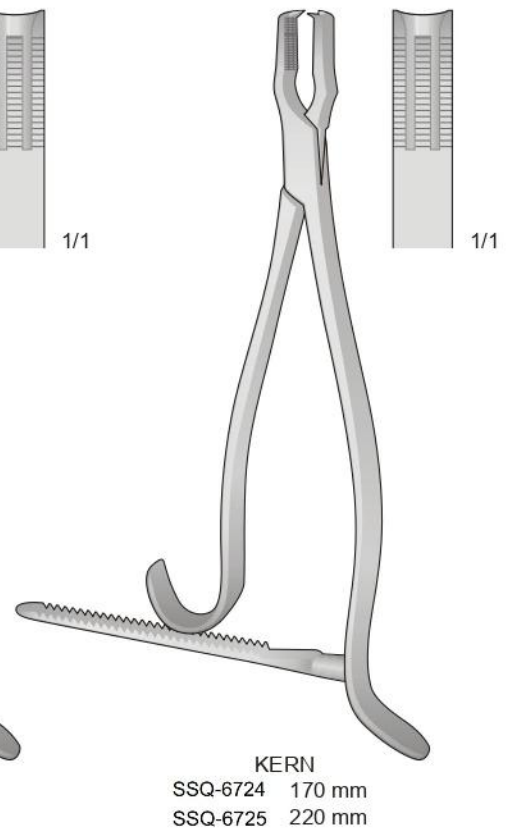
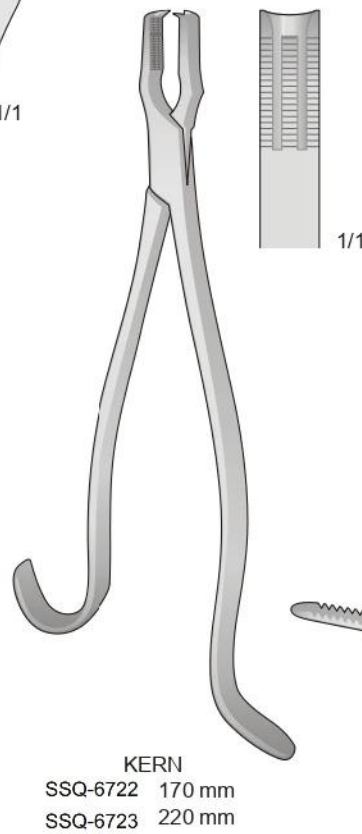
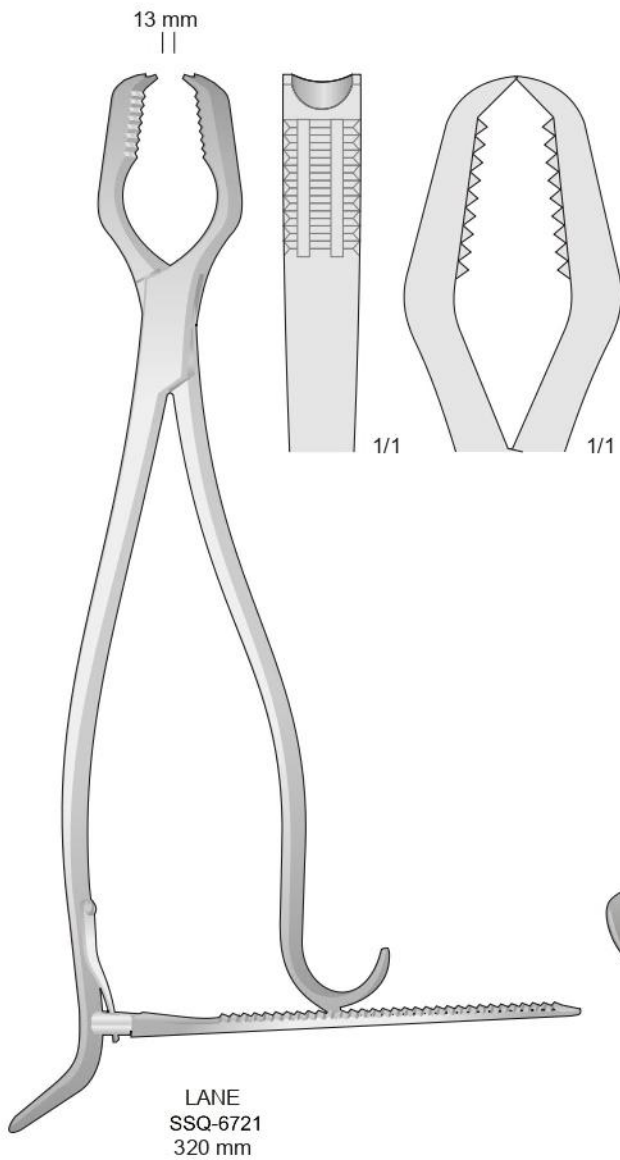

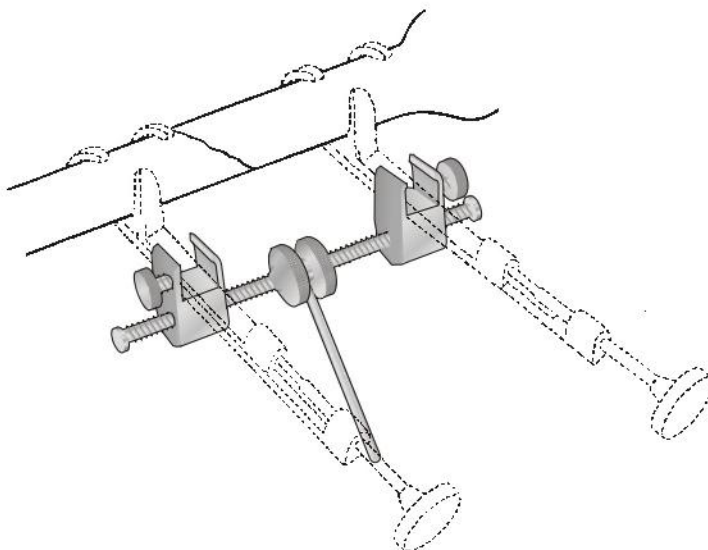

GERSTER  
SSQ-6726



GERSTER-LOWMAN  
SSQ-6727 120 mm  
SSQ-6728 185 mm  
SSQ-6729 200 mm

Per bambini  
For children  
Für kinder  
Pour enfants  
Para niños

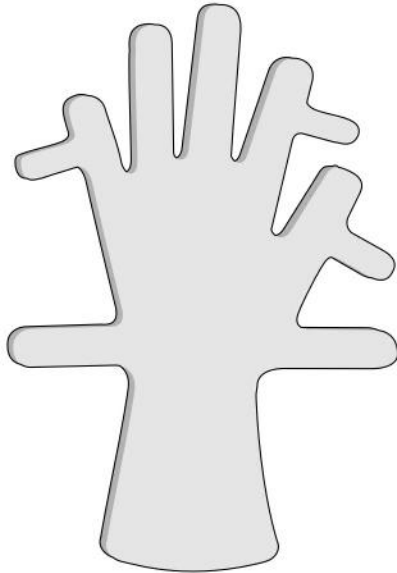

SSQ-6730

Per adulti - For adults - Für Erwachsene  
Pour adultes - Para adultos

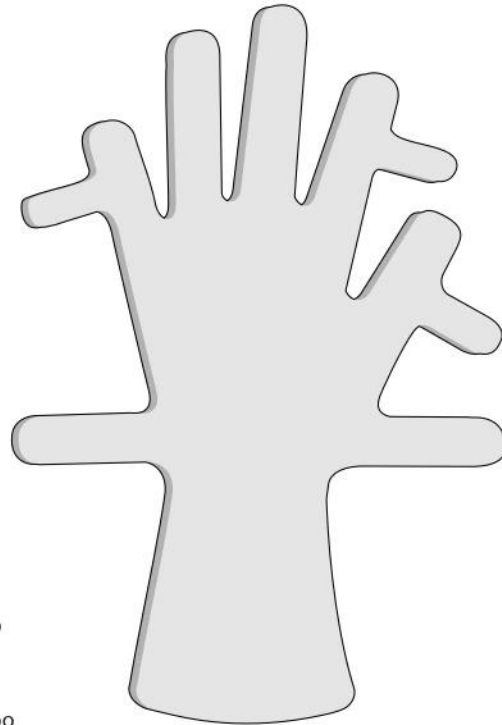

Mani di piombo  
Lead hands  
Bleihände  
Main de plomb  
Manos de plombo

SSQ-6731

Pinza taglia anelli - Forceps for opening rings  
Fingerringssägen - Scies pour bagues - Sierra para anillos

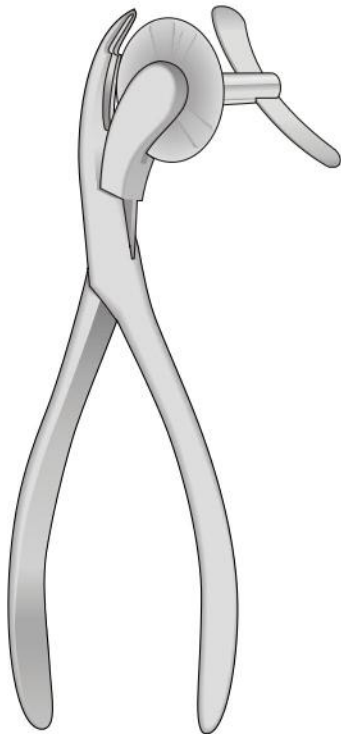

SSQ-6732  
170 mm

Pinza per estrazione delle unghie  
Nail extracting forceps  
Nagelaus reisszange  
Pince pour extraire les ongles  
Pinzas para arrancar uñas

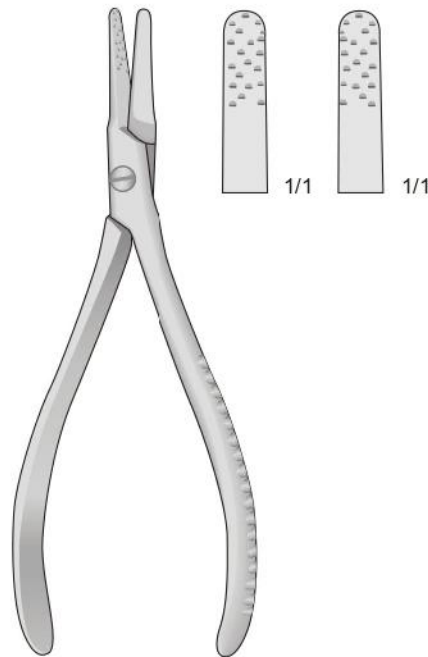

RADOLF  
SSQ-6733  
135 mm

Pinza per unghie  
Nail nipper  
Nagelspaltzange  
Pince à ongles  
Pinzas corta uñas

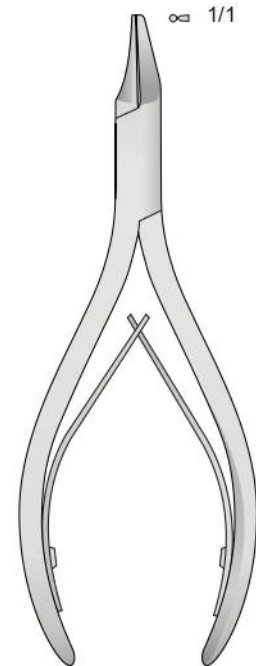

SSQ-6734  
135 mm

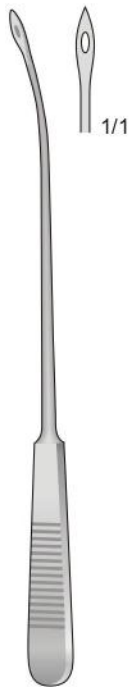

OBWEGESER  
SSQ-6735  
140 mm

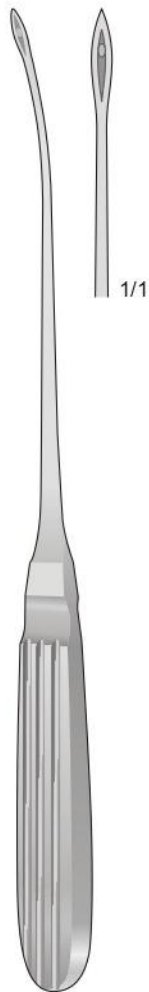

OBWEGESER  
SSQ-6736  
230 mm



SSQ-6737  
180 mm

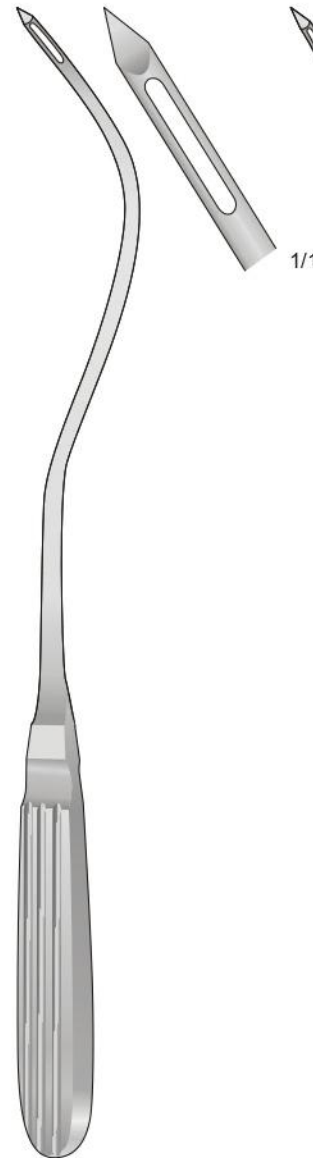

SANDERS-BROWN  
SSQ-6738  
290 mm

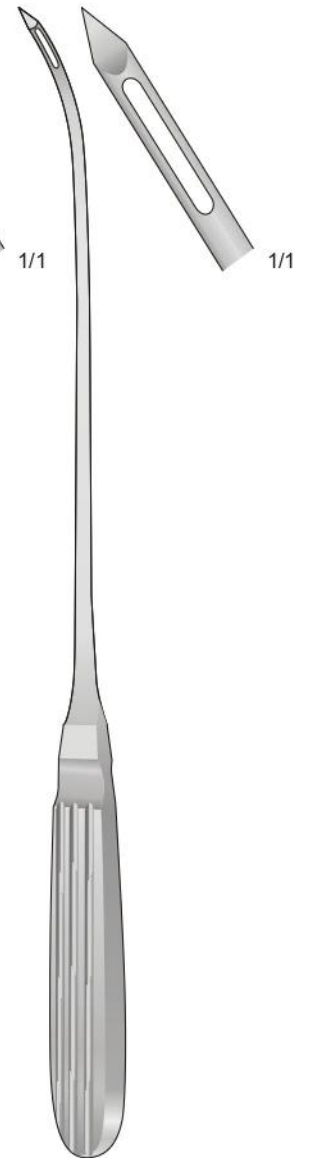

SANDERS-BROWN  
SSQ-6739  
300 mm

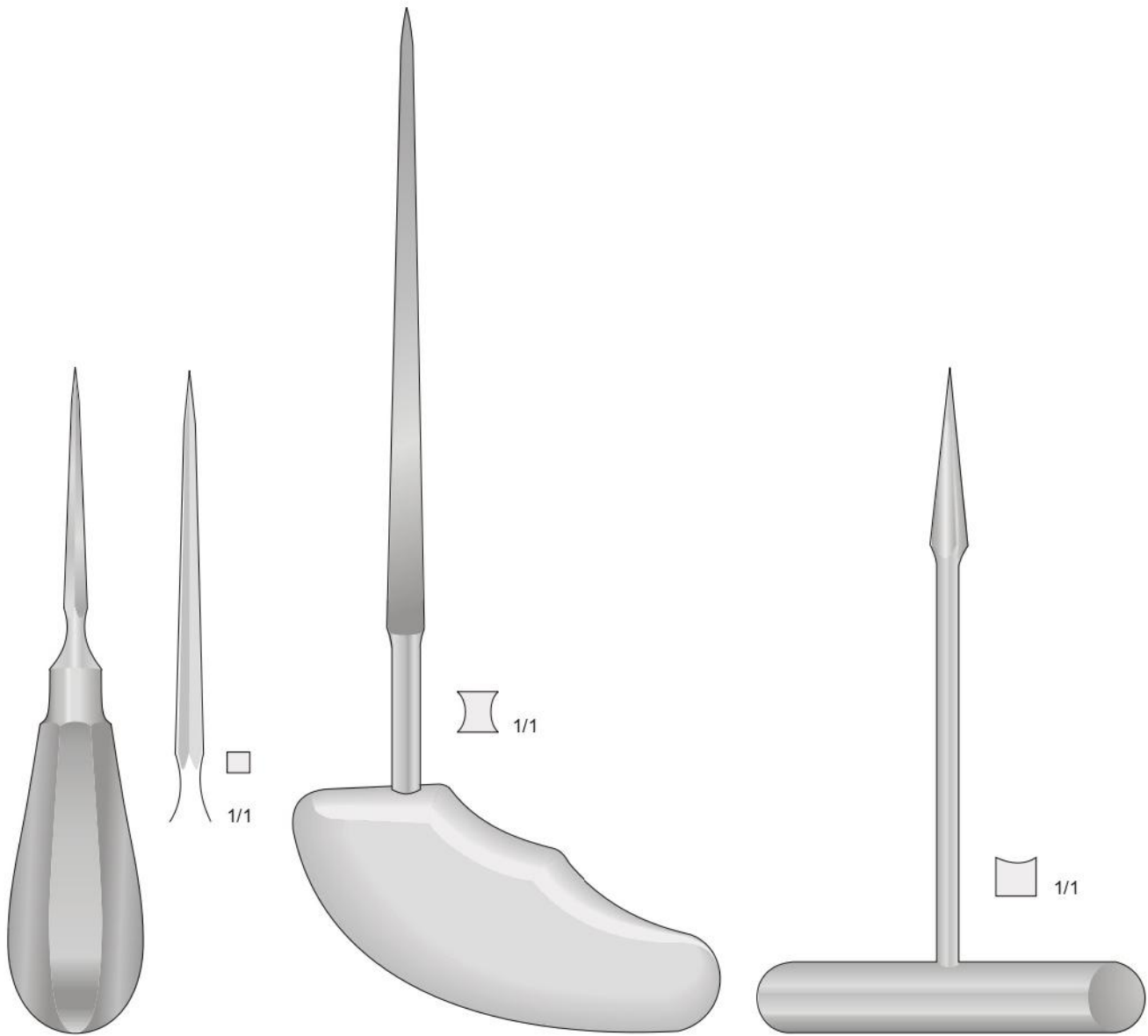

SSQ-6740  
140 mm

PERTHES  
SSQ-6741  
210 mm

SSQ-6742  
140 mm

Punche da biopsia - Hautstanzen  
Dermal punches - Trépanos cutáneos



-   
 SSQ-6744  
3 mm
-   
 SSQ-6745  
4 mm
-   
 SSQ-6746  
5 mm
-   
 SSQ-6747  
6 mm

KEYES  
SSQ-6743  
100 mm

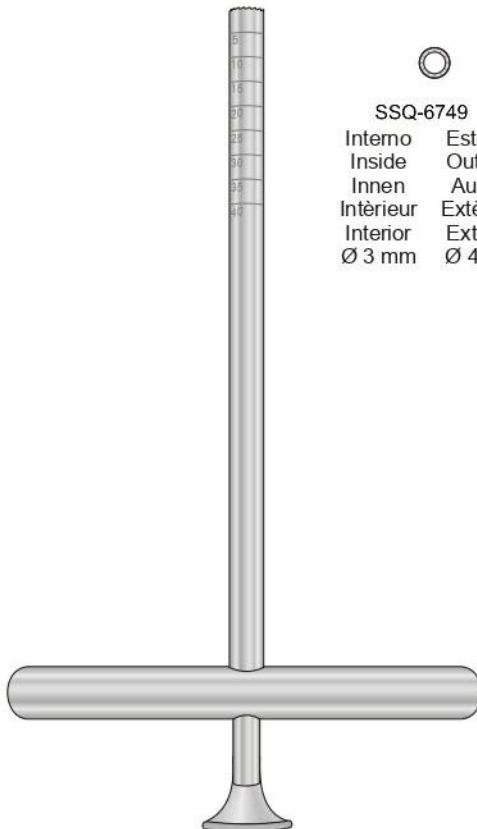

SSQ-6748  
170 mm

- |   |           |   |           |   |           |
|---|-----------|---|-----------|---|-----------|
|  |           |  |           |  |           |
| SSQ-6749  |           | SSQ-6750  |           | SSQ-6751  |           |
| Interno   | Esterno   | Interno   | Esterno   | Interno   | Esterno   |
| Inside  | Outside   | Inside  | Outside   | Inside  | Outside   |
| Innen   | Außen     | Innen   | Außen     | Innen   | Außen     |
| Intérieur   | Extérieur | Intérieur   | Extérieur | Intérieur   | Extérieur |
| Interior  | Exterior  | Interior  | Exterior  | Interior  | Exterior  |
| Ø 3 mm  | Ø 4 mm    | Ø 3,9 mm  | Ø 5 mm    | Ø 6,4 mm  | Ø 8 mm    |



12-1260-01  
Set completo di 4 pezzi  
Set complete with 4 pieces  
Komplettset mit 4 Teilen  
Set complet avec 4 pièces  
Set completo con 4 piezas

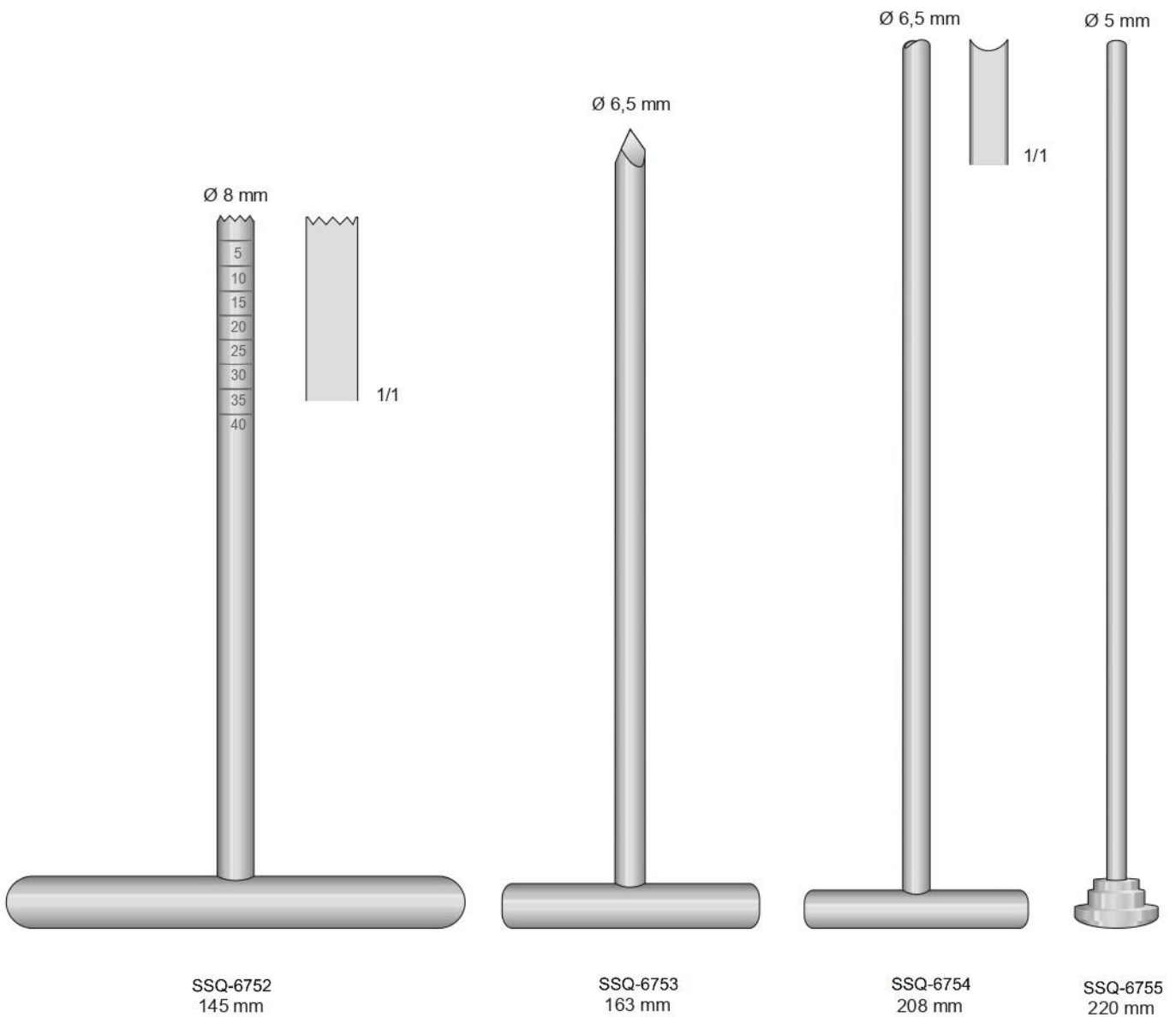

Set completo di 4 pezzi  
Set complete with 4 pieces  
Kompletset mit 4 Teilen  
Set complet avec 4 pièces  
Set completo con 4 piezas

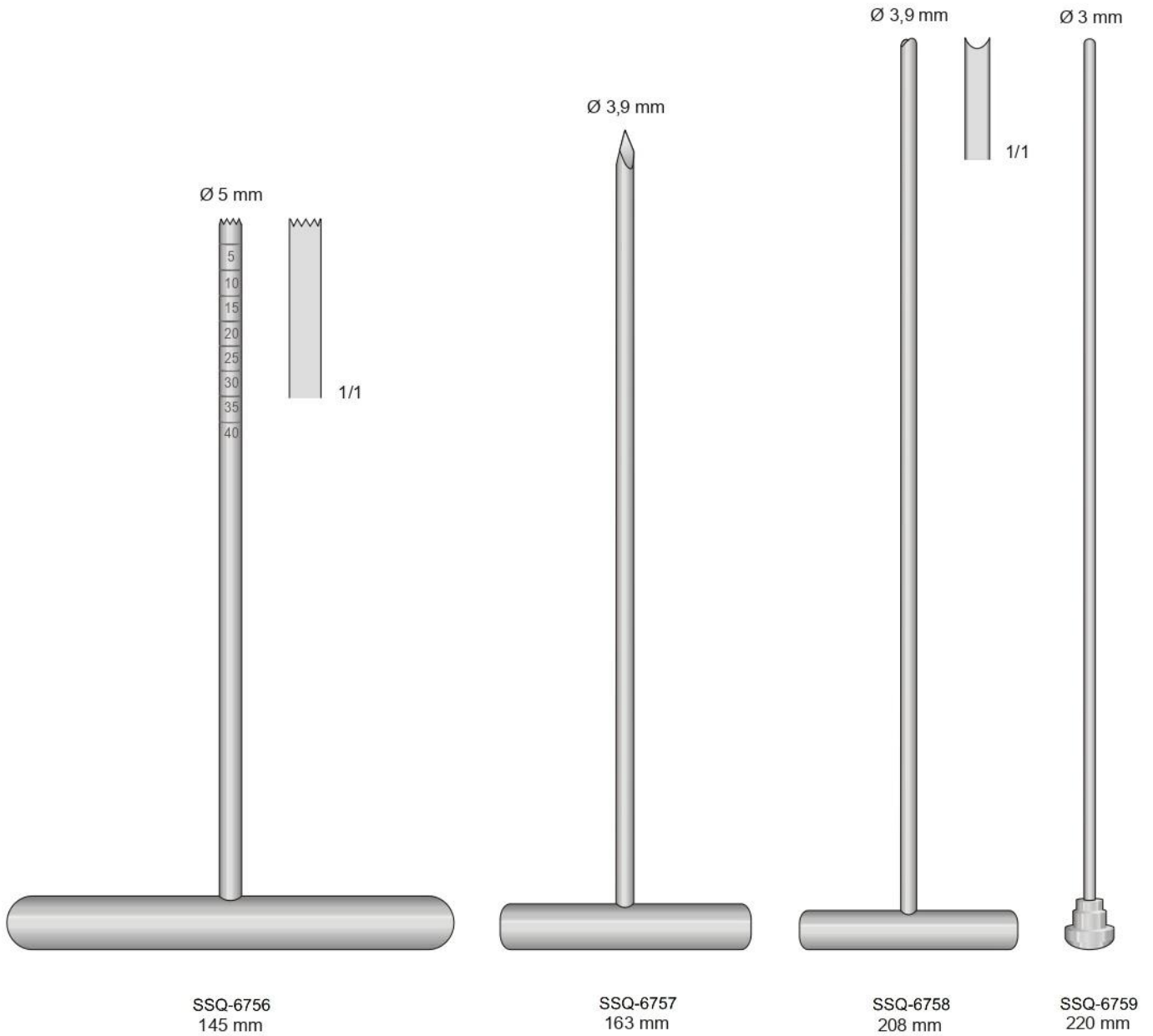



**KIRSCHNER**  
Punta trequarti  
Trocar point  
Trokarspitze  
Pointe de Trocart  
Punta de tròcar



**KIRSCHNER**  
Punta trequarti  
Trocar point  
Trokarspitze  
Pointe de Trocart  
Punta de tròcar



**KIRSCHNER**  
Punte lanceolate  
Lance point  
Lanzenspitze  
Pointe lancette  
Punta lanceolar

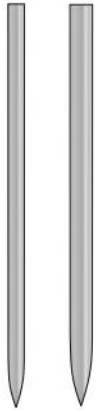

Punta trequarti  
Trocar point  
Trokarspitze  
Pointe de Trocart  
Punta de tròcar

310 mm

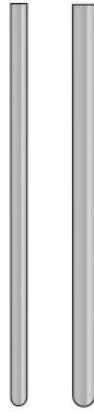

Punta rotonda  
Round shaft  
Rundes ende  
Pointe ronde  
Punta redonda

310 mm

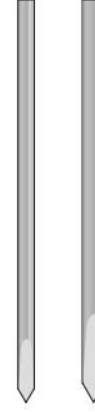

Punte lanceolate  
Lance point  
Lanzenspitze  
Pointe lancette  
Punta lanceolar

310 mm

Ø/Diam.	Conf. 10 pz.
0,8 mm	SSQ-6760-1
1,0 mm	SSQ-6760-2
1,2 mm	SSQ-6760-3
1,4 mm	SSQ-6760-4
1,5 mm	SSQ-6760-5
1,6 mm	SSQ-6760-6
1,7 mm	SSQ-6760-7
1,8 mm	SSQ-6760-8
2,0 mm	SSQ-6760-9
2,2 mm	SSQ-6760-10
2,5 mm	SSQ-6760-11
3,0 mm	SSQ-6760-12

Ø/Diam.	Conf. 10 pz.
0,8 mm	SSQ-6761-1
1,0 mm	SSQ-6761-2
1,2 mm	SSQ-6761-3
1,4 mm	SSQ-6761-4
1,5 mm	SSQ-6761-5
1,6 mm	SSQ-6761-6
1,7 mm	SSQ-6761-7
1,8 mm	SSQ-6761-8
2,0 mm	SSQ-6761-9
2,2 mm	SSQ-6761-10
2,5 mm	SSQ-6761-11
3,0 mm	SSQ-6761-12

Ø/Diam.	Conf. 10 pz.
0,8 mm	SSQ-6762-1
1,0 mm	SSQ-6762-2
1,2 mm	SSQ-6762-3
1,5 mm	SSQ-6762-4
1,6 mm	SSQ-6762-5
1,8 mm	SSQ-6762-6
2,0 mm	SSQ-6762-7
2,2 mm	SSQ-6762-8
2,5 mm	SSQ-6762-9
3,0 mm	SSQ-6762-10



**KIRSCHNER**  
Punta tre quarti  
Trocar point  
Trokar Spitze  
Pointe de Trocart  
Punta de tròcar



**KIRSCHNER**  
Punta tre quarti  
Trocar point  
Trokar Spitze  
Pointe de Trocart  
Punta de tròcar



15 mm

Con filettatura  
With thread  
Mit gewinde  
Avec filetage  
Con rosca

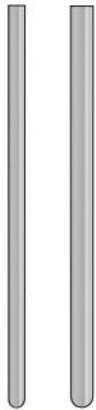

Punta rotonda  
Round shaft  
Rundes ende  
Pointe ronde  
Punta redonda

150 mm



Punta tre quarti  
Trocar point  
Trokar Spitze  
Pointe de Trocart  
Punta de tròcar

150 mm



Rotonda  
Round  
Runde  
Ronde  
Redonda

○

Ø/Diam.	Conf. 10 pz.
0,8 mm	SSQ-6763-1
1,0 mm	SSQ-6763-2
1,2 mm	SSQ-6763-3
1,4 mm	SSQ-6763-4
1,5 mm	SSQ-6763-5
1,6 mm	SSQ-6763-6
1,7 mm	SSQ-6763-7
1,8 mm	SSQ-6763-8
2,0 mm	SSQ-6763-9
2,2 mm	SSQ-6763-10
2,5 mm	SSQ-6763-11
3,0 mm	SSQ-6763-12

Ø/Diam.	Conf. 10 pz.
0,8 mm	SSQ-6764-1
1,0 mm	SSQ-6764-2
1,2 mm	SSQ-6764-3
1,4 mm	SSQ-6764-4
1,6 mm	SSQ-6764-5

KIRSCHNER			
Codice	Ø mm	Lung.	Lung. filo
SSQ-6765-1	1,5	150	5
SSQ-6765-1	1,6	150	15
SSQ-6765-1	2	150	15
SSQ-6765-1	2	200	15

KIRSCHNER

Bundel-Nagel



500 mm

Steinmann pins



310 mm

Küntscher

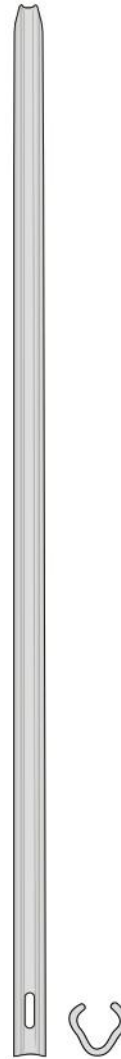

400 mm

Threaded Steinmann Pins



230 mm

Runde

Ø/Diam.	Conf. 10 pz.
2,0 mm	SSQ-6766-1
2,5 mm	SSQ-6766-2
3,0 mm	SSQ-6766-3
3,5 mm	SSQ-6766-4
4,0 mm	SSQ-6766-5
4,5 mm	SSQ-6766-6
5,0 mm	SSQ-6766-7
5,5 mm	SSQ-6766-8
6,0 mm	SSQ-6766-9

Ø/Diam.	Conf. 1 pz.
3,5 mm	SSQ-6767-1
4,0 mm	SSQ-6767-2
4,5 mm	SSQ-6767-3
5,0 mm	SSQ-6767-4
6,0 mm	SSQ-6767-5
6,5 mm	SSQ-6767-6

Ø/Diam.	Conf. 1 pz.
6,0 mm	SSQ-6768-1
7,0 mm	SSQ-6768-2
8,0 mm	SSQ-6768-3
9,0 mm	SSQ-6768-4
10 mm	SSQ-6768-5
11 mm	SSQ-6768-6
12 mm	SSQ-6768-7

Ø/Diam.	Conf. 1 pz.
2,0 mm	SSQ-6769-1
2,5 mm	SSQ-6769-2

Steinmann Pins with Central Thread with Trocar Point

Contenitore per  
sterilizzazione Kirschner  
Bohrdrahtspender

Positivo  
Thread - Ø is 0,5 mm  
more than pin - Ø

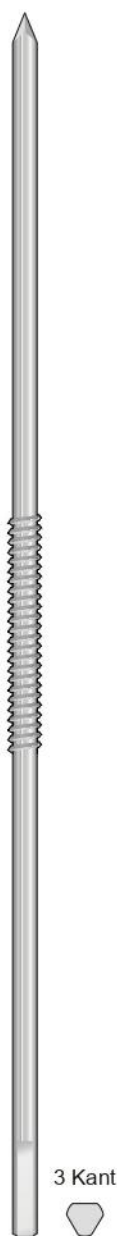

STEINMANN PINS			
Codice	Ø mm	Lung.	Lung. Filo mm
SSQ-6770-1	3	150	37
SSQ-6770-2	3	180	48
SSQ-6770-3	3	200	50
SSQ-6770-4	3	230	52
SSQ-6770-5	3,5	150	37
SSQ-6770-6	3,5	180	52
SSQ-6770-7	3,5	200	52
SSQ-6770-8	3,5	230	52
SSQ-6770-9	4	150	37
SSQ-6770-10	4	180	52
SSQ-6770-11	4	200	50
SSQ-6770-12	4	230	52
SSQ-6770-13	4	250	52
SSQ-6770-14	4,5	150	37
SSQ-6770-15	4,5	180	52
SSQ-6770-16	4,5	200	52
SSQ-6770-17	4,5	230	52
SSQ-6770-18	4,5	250	52
SSQ-6770-19	4,5	300	52
SSQ-6770-20	5	150	37
SSQ-6770-21	5	180	52
SSQ-6770-22	5	200	50
SSQ-6770-23	5	230	52
SSQ-6770-24	5	250	52
SSQ-6770-25	5	300	52

SSQ-6770

Ø 10 mm



SSQ-6771-1 - 320 mm  
SSQ-6771-2 - 185 mm

Viti di Schanz  
Shanz screws  
Schanz'sche Schrauben  
Vis de Schanz

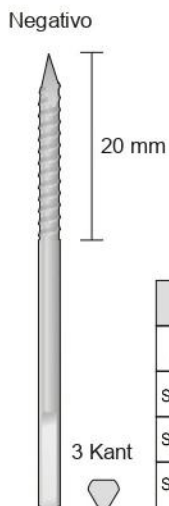

SCHANZ			
Codice	Ø mm	Lung.	Lung. filo
SSQ-6772-1	3	60	20
SSQ-6772-2	3	80	20
SSQ-6772-3	4	60	25

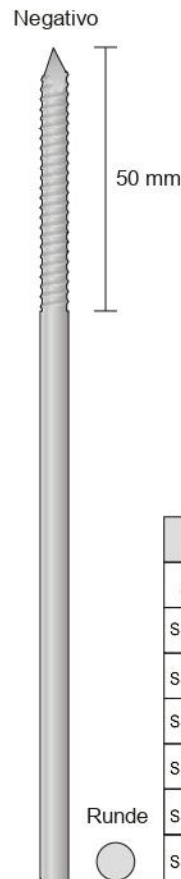

SCHANZ			
Codice	Ø mm	Lung.	Lung. filo
SSQ-6773-1	2	150	50
SSQ-6773-2	3	150	50
SSQ-6773-3	3,5	150	50
SSQ-6773-4	4	150	50
SSQ-6773-5	4,5	150	50
SSQ-6773-6	5	150	50

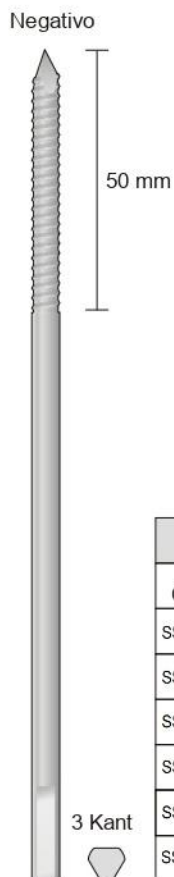

SCHANZ			
Codice	Ø mm	Lung.	Lung. filo
SSQ-6774-1	2	150	50
SSQ-6774-2	3	150	50
SSQ-6774-3	3,5	150	50
SSQ-6774-4	4	150	50
SSQ-6774-5	4,5	150	50
SSQ-6774-6	5	150	50

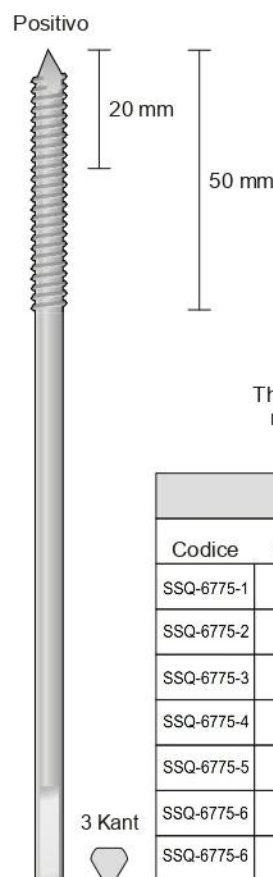

Thread - Ø is 0,5 mm  
more than pin - Ø

SCHANZ			
Codice	Ø mm	Lung.	Lung. filo
SSQ-6775-1	2	150	20
SSQ-6775-2	3	150	20
SSQ-6775-3	3,5	150	50
SSQ-6775-4	4	150	25
SSQ-6775-5	4	150	50
SSQ-6775-6	4,5	150	50
SSQ-6775-6	5	150	50

Strumenti per filo di cerchiaggio  
Wire instrument set  
Drahtinstrumentarium  
Instruments à fil  
Instrumental para cerclaje

Filo malleabile  
per compattare l'osso  
Wire soft  
Draht weich  
Fil à os  
Alambre ligadura



10 mt.

Ø/Diam.	Codice
0,2 mm	SSQ-6776-1
0,3 mm	SSQ-6776-2
0,4 mm	SSQ-6776-3
0,5 mm	SSQ-6776-4
0,6 mm	SSQ-6776-5
0,7 mm	SSQ-6776-6
0,8 mm	SSQ-6776-7
0,9 mm	SSQ-6776-8
1,0 mm	SSQ-6776-9
1,2 mm	SSQ-6776-10
1,5 mm	SSQ-6776-11

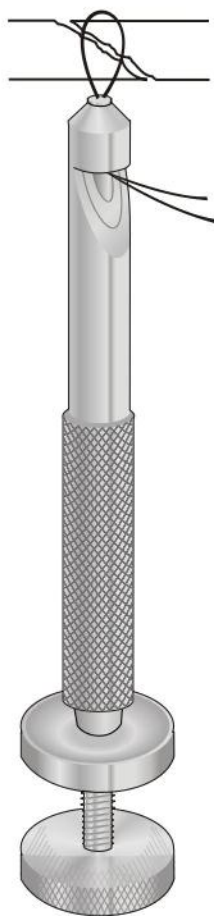

LOUTE  
SSQ-6776  
220 mm

Strumenti tendifili  
Bone wire tighteners  
Drahtspanninstrument  
Tendeur serre fils  
Tensor cierra-hilos

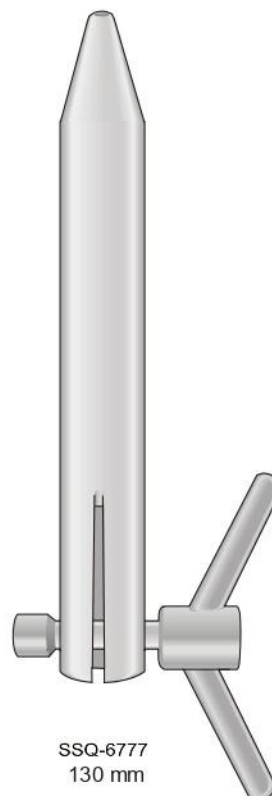

SSQ-6777  
130 mm



Fino a Ø 3 mm  
Bis Ø 3 mm  
Up to Ø 3 mm

Gancio d'estrazione  
Extraction hooks  
Extraktions haken  
Crochets d'extraction  
Ganchos extractores

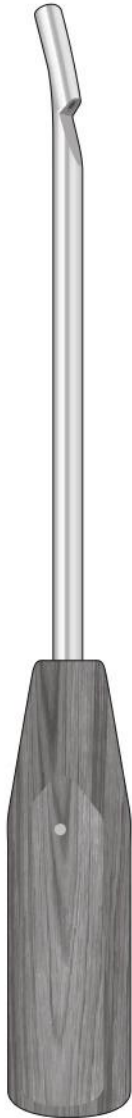

WAGNER  
12-1460-30  
300 mm

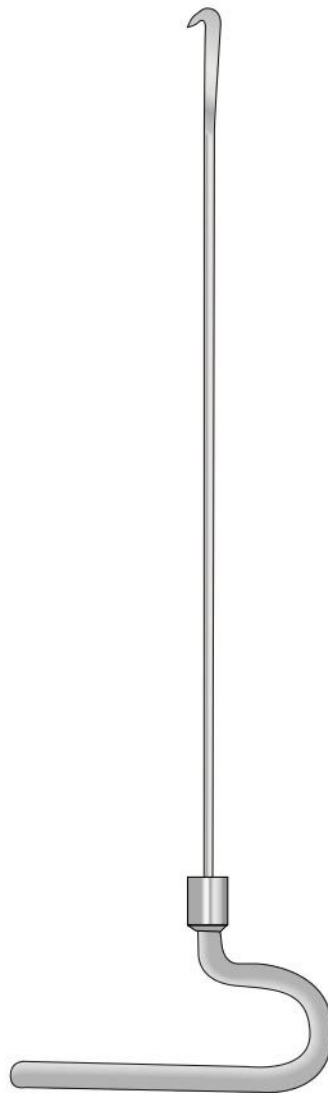

SSQ-6779 - 290 mm  
SSQ-6780 - 370 mm  
SSQ-6781 - 420 mm



SSQ-6782  
120 mm



KÜNTSCHNER  
SSQ-6783  
210 mm

SSQ-6784  
Completo con - Complete with  
Komplett mit - Completes avec  
Completo con:  
1 LS-236  
1 LS-229  
1 LS-241

Attacco AO

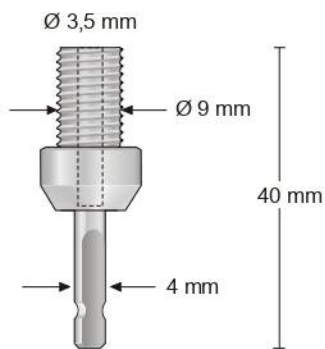

SSQ-6784-1  
40 mm

Inox  
ORIGINAL JACOBS

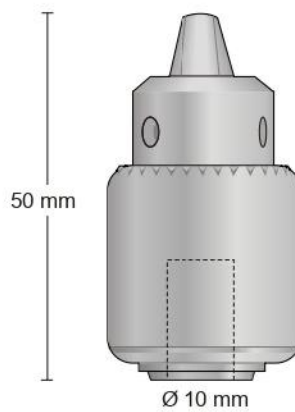

SSQ-6784-2  
50 mm

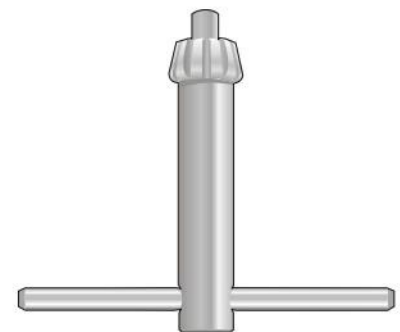

SSQ-6784-3  
52 mm

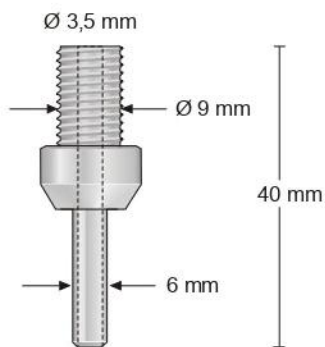

SSQ-6784-4  
40 mm

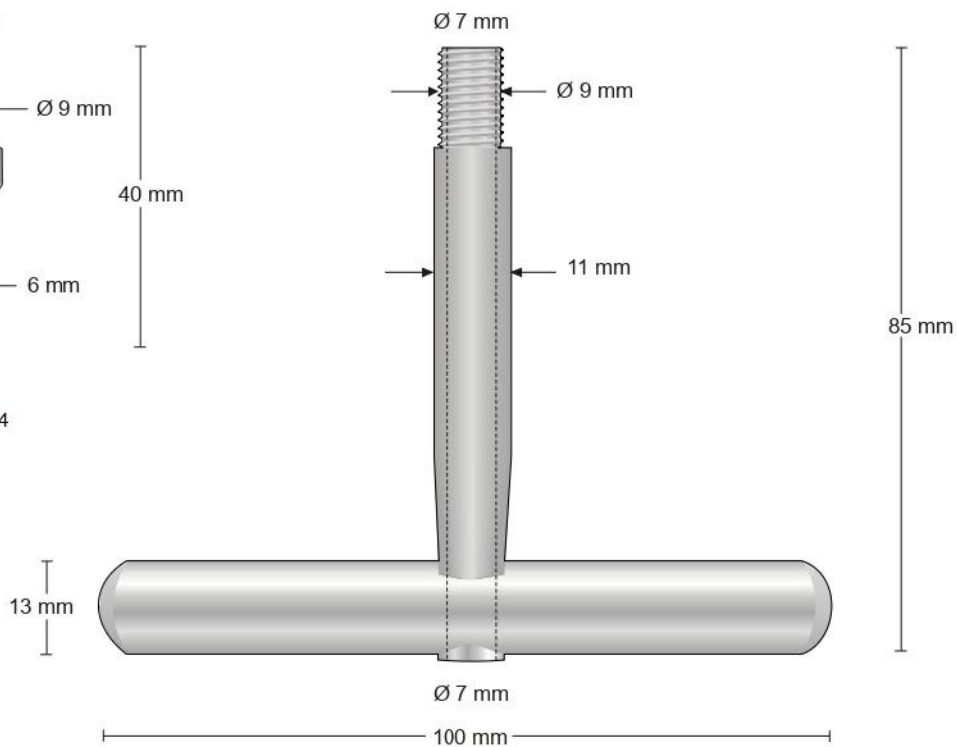

SSQ-6784-5  
85 mm

SSQ-6785  
Completo con - Complete with  
Komplett mit - Completes avec  
Completo con:  
1  
1  
1  
1

Inox  
ORIGINAL JACOBS

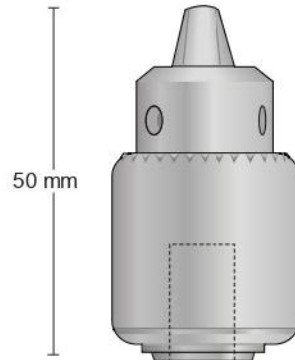

Ø 10 mm

SSQ-6785-01  
50 mm

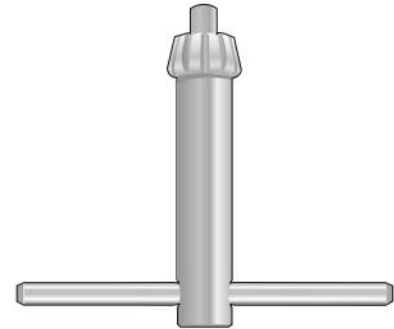

SSQ-6785-04  
52 mm

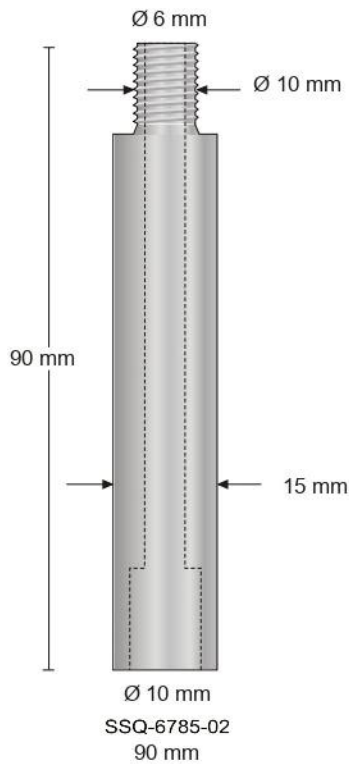

Ø 10 mm  
SSQ-6785-02  
90 mm

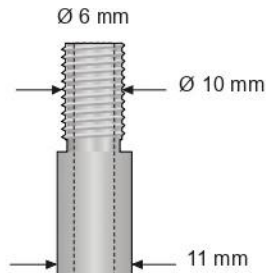

130 mm

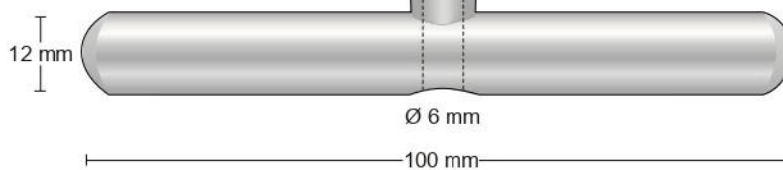

SSQ-6785-03  
130 mm

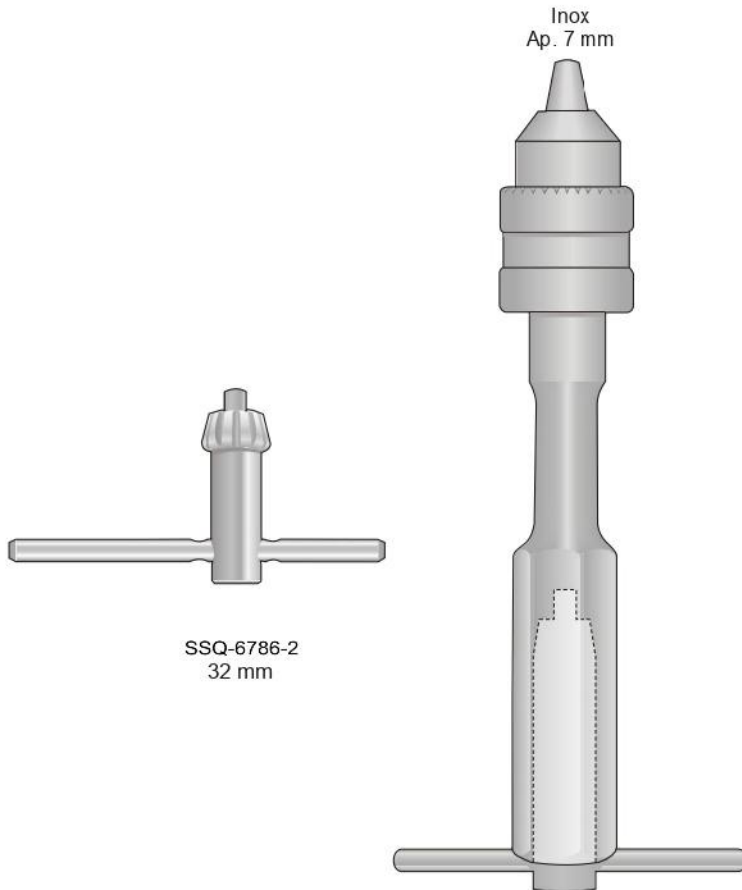

SSQ-6786-2  
32 mm

Inox  
Ap. 7 mm

SSQ-6786-1  
130 mm

Con chiusura a mano  
Von Hand zu spannen  
tightened by hand

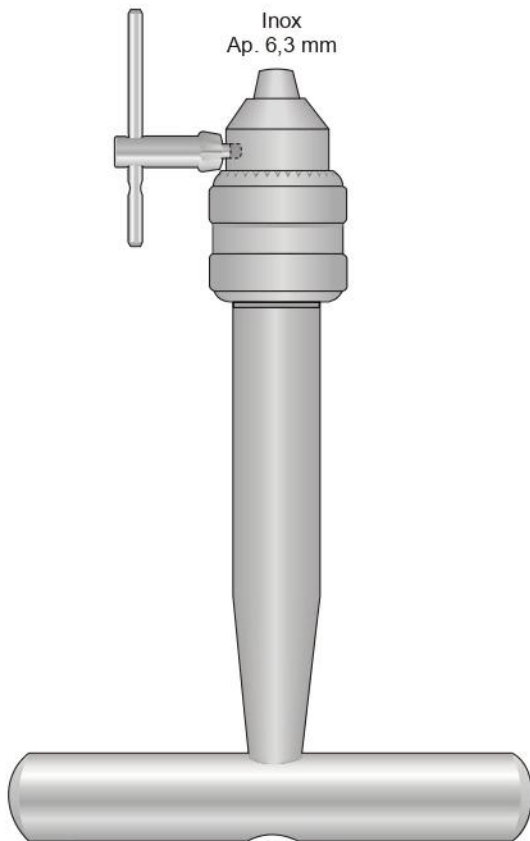

SSQ-6787  
130 mm

Inox  
Ap. 6,3 mm

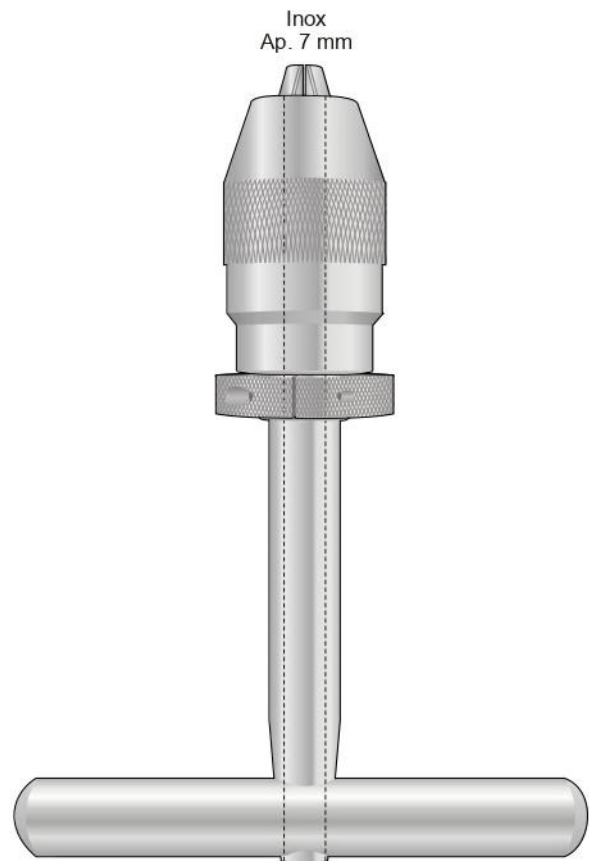

SSQ-6788  
135 mm

Inox  
Ap. 7 mm



DEMEL  
12-1560

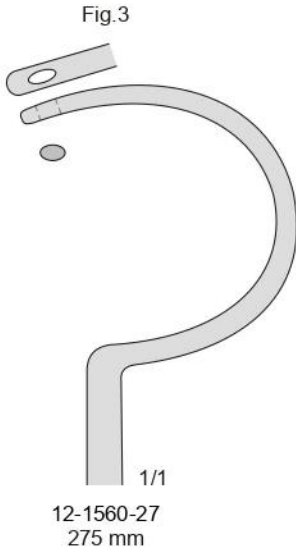

12-1560-27  
275 mm

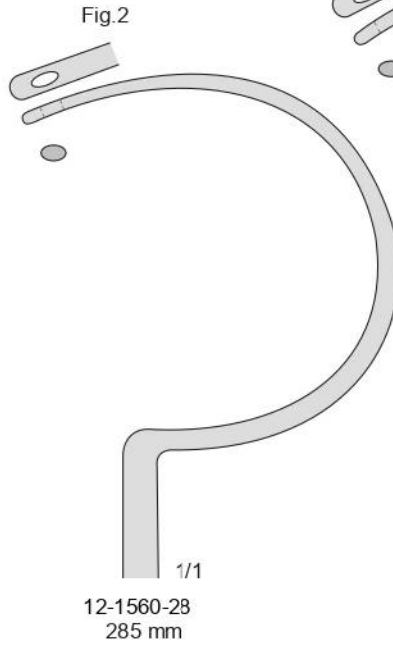

12-1560-28  
285 mm

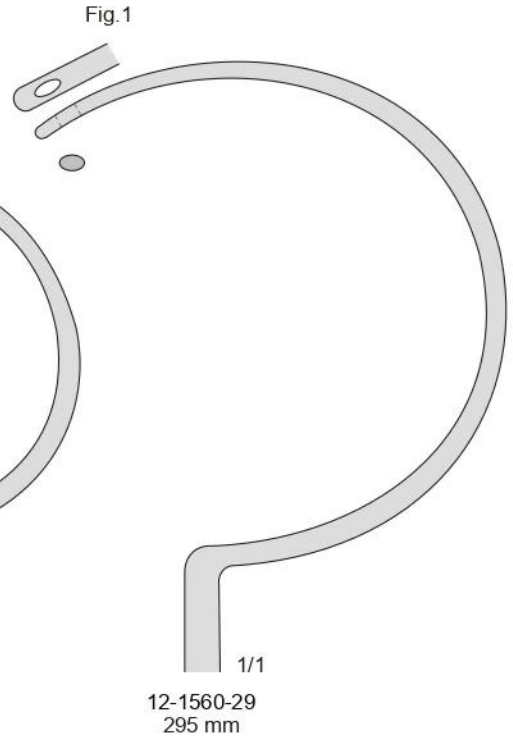

12-1560-29  
295 mm



SSQ-6790  
225 mm

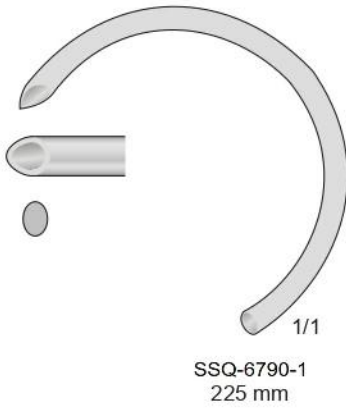

SSQ-6790-1  
225 mm

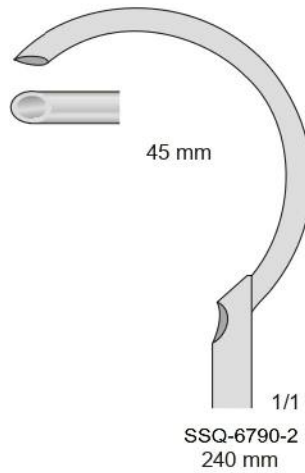

SSQ-6790-2  
240 mm

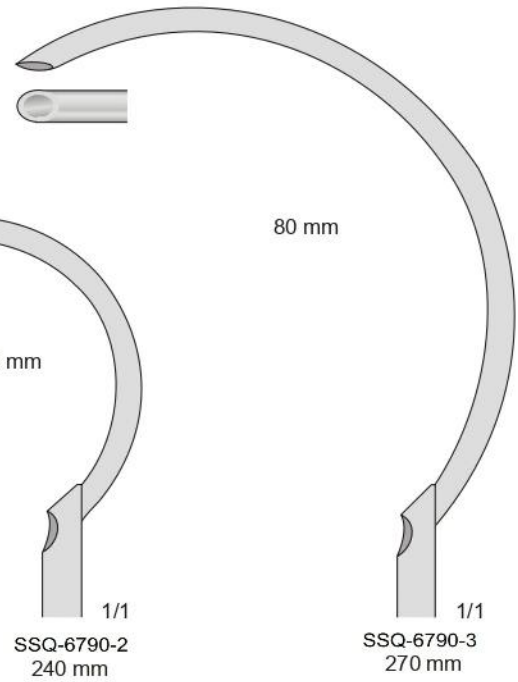

SSQ-6790-3  
270 mm

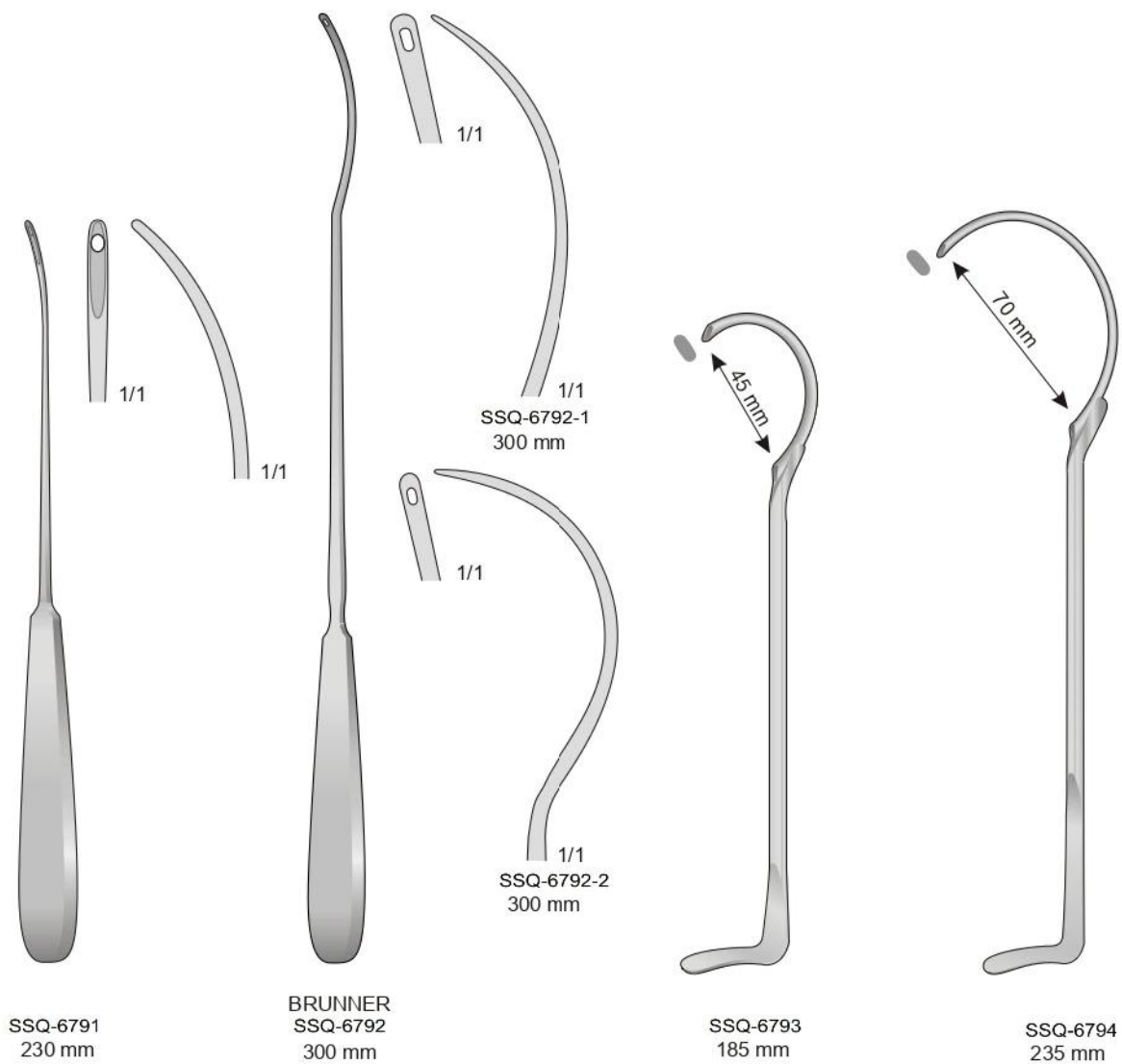

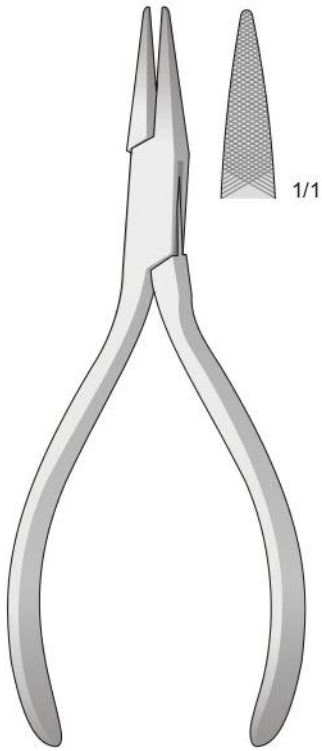

SSQ-6795  
140 mm

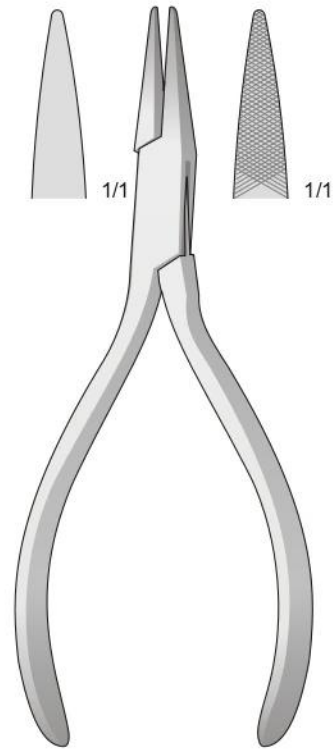

SSQ-6796  
140 mm

Per filo duro ø 1 mm  
For hard wire ø 1 mm  
Für harten draht ø 1 mm  
Pour fil dur ø 1 mm  
Para alambres duro ø 1 mm

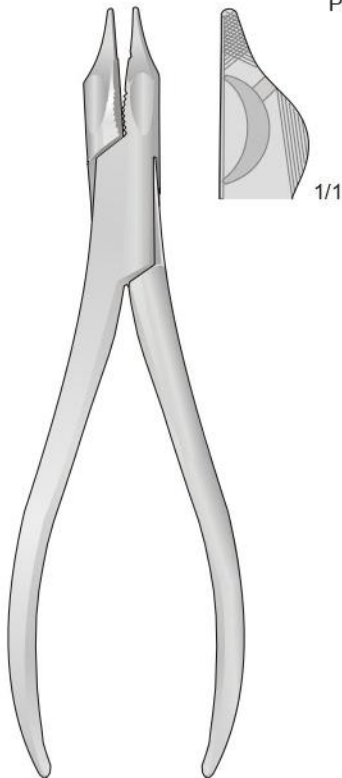

SSQ-6797  
150 mm

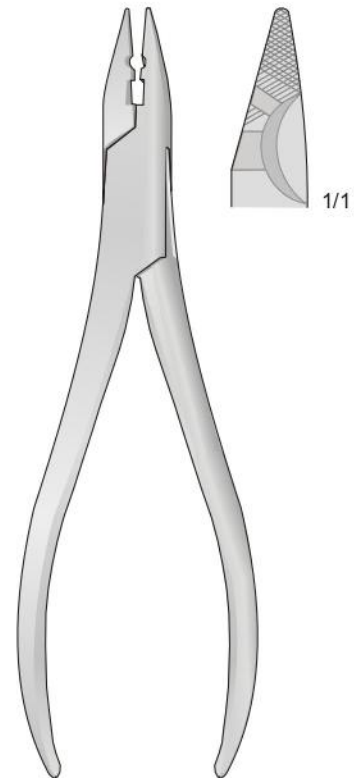

SSQ-6798  
160 mm

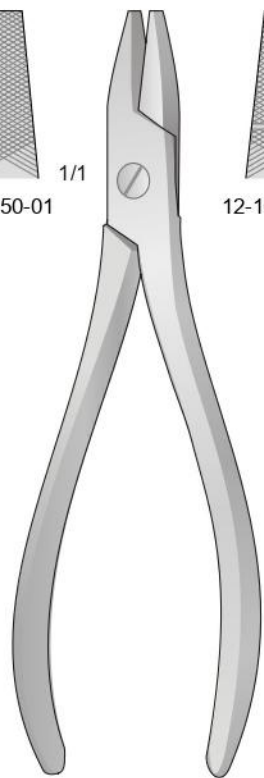
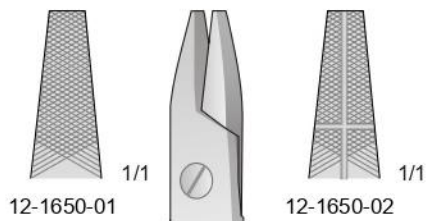

SSQ-6799  
175 mm

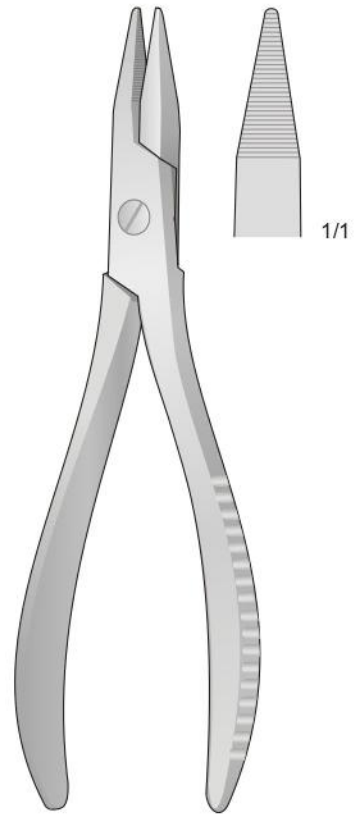

SSQ-6800  
190 mm

Pinza per estrazione  
fili metallici  
Flachzangen für draht

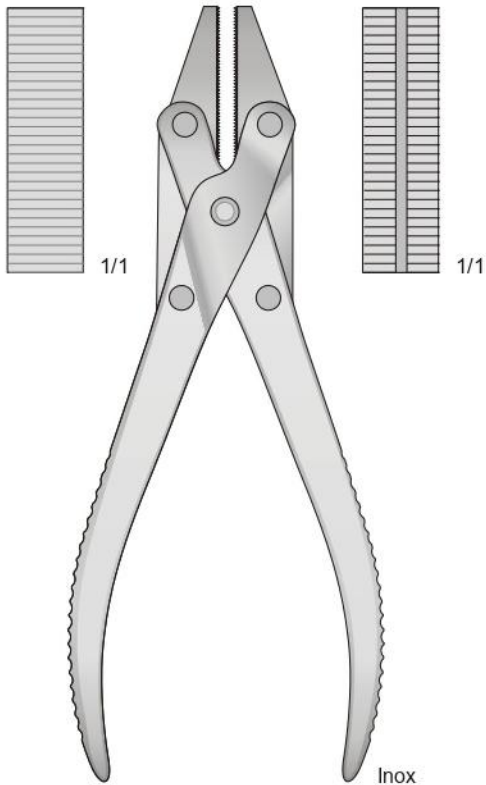

SSQ-6801  
185 mm

Pinza a branche parallele  
con tronchese

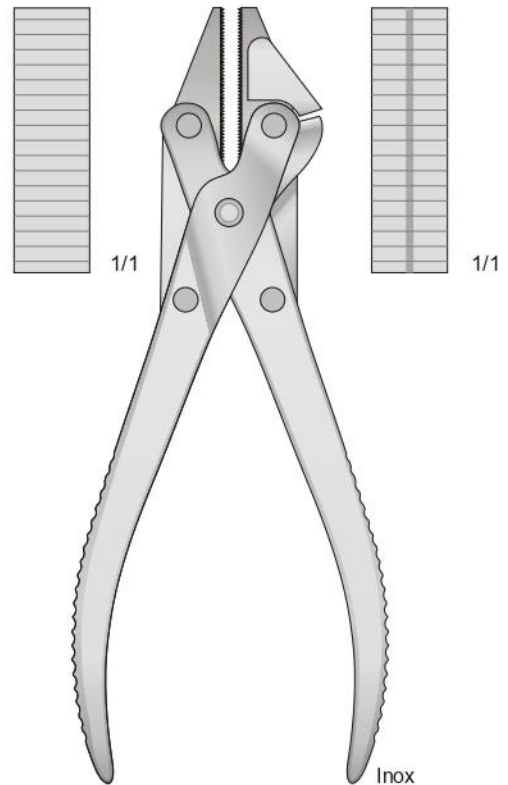

SSQ-6802  
185 mm



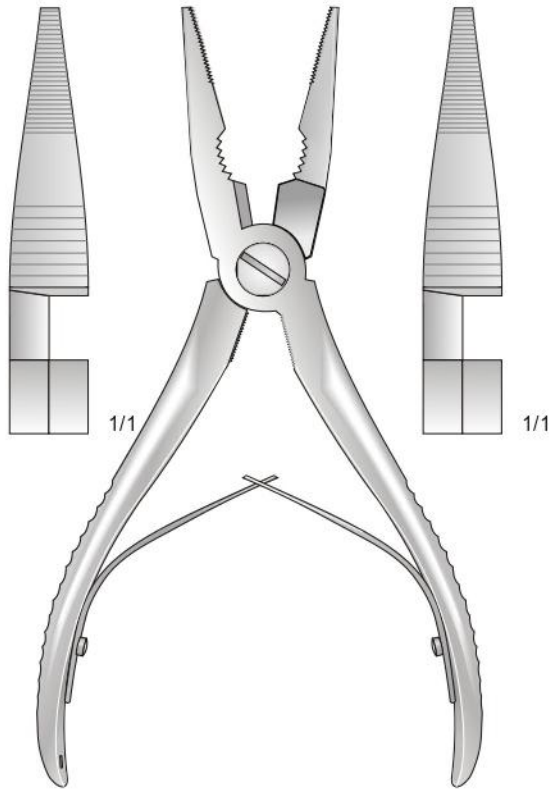

SSQ-6803  
175 mm

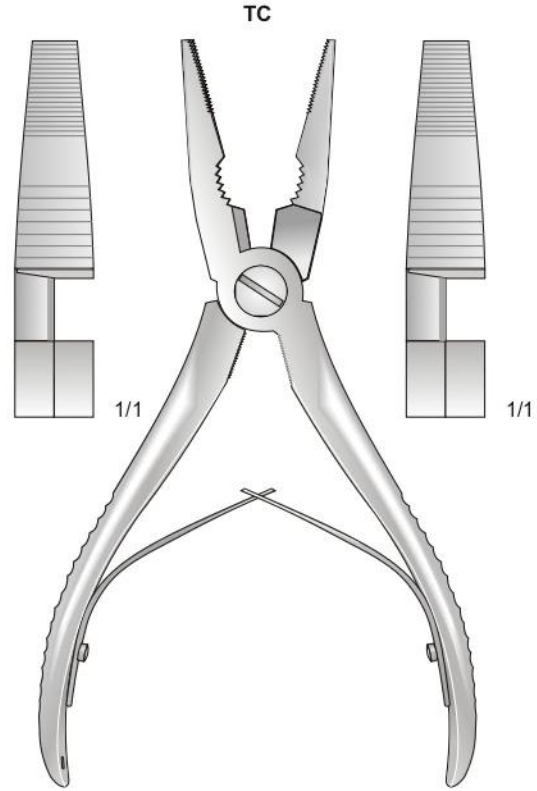

SSQ-6804  
165 mm

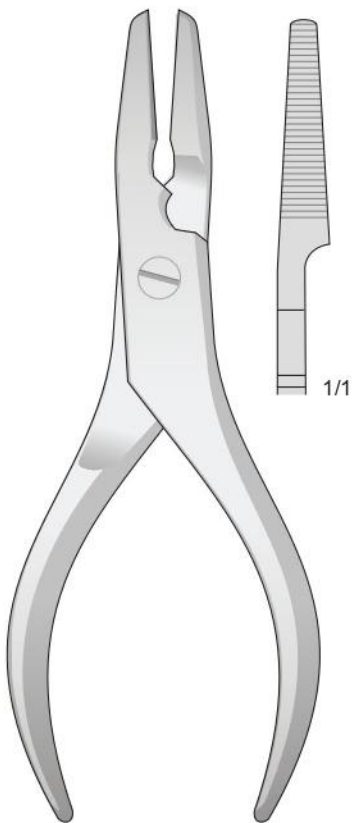

SSQ-6805  
160 mm

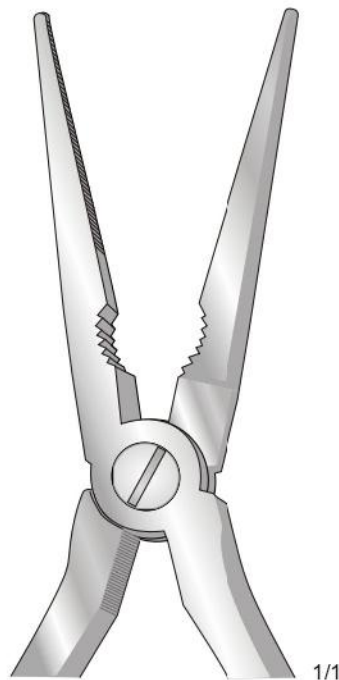

12-1700-20  
200 mm

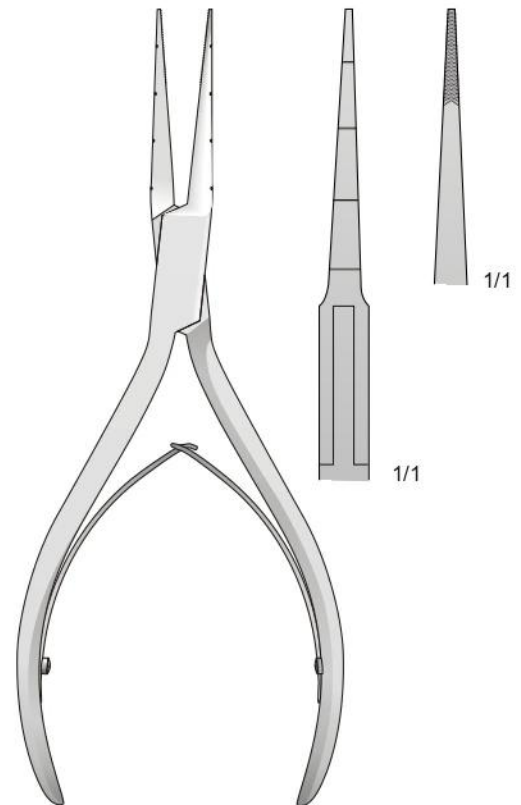

SSQ-6806  
150 mm

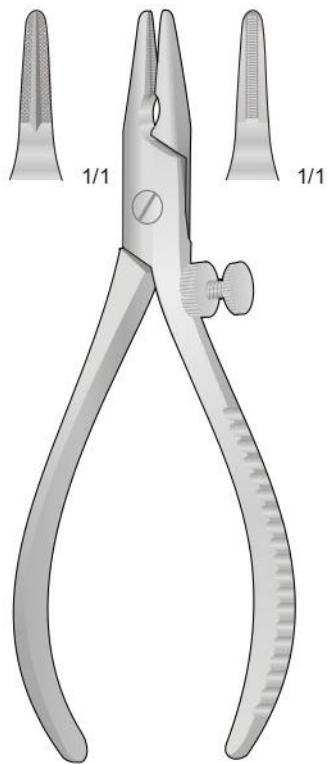

SSQ-6807  
140 mm

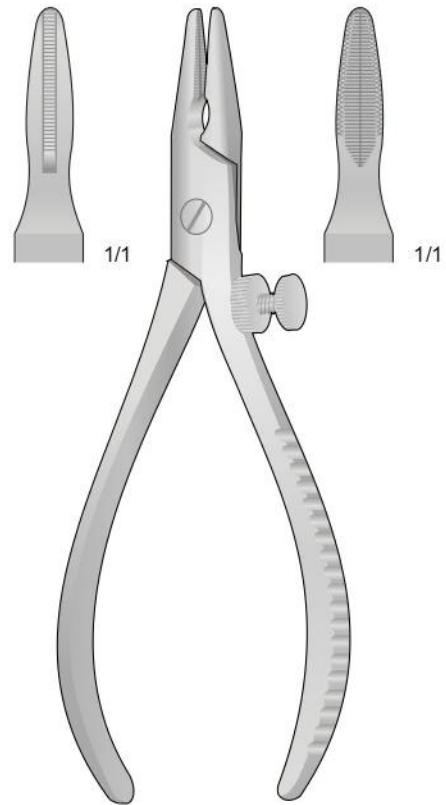

SSQ-6808  
180 mm

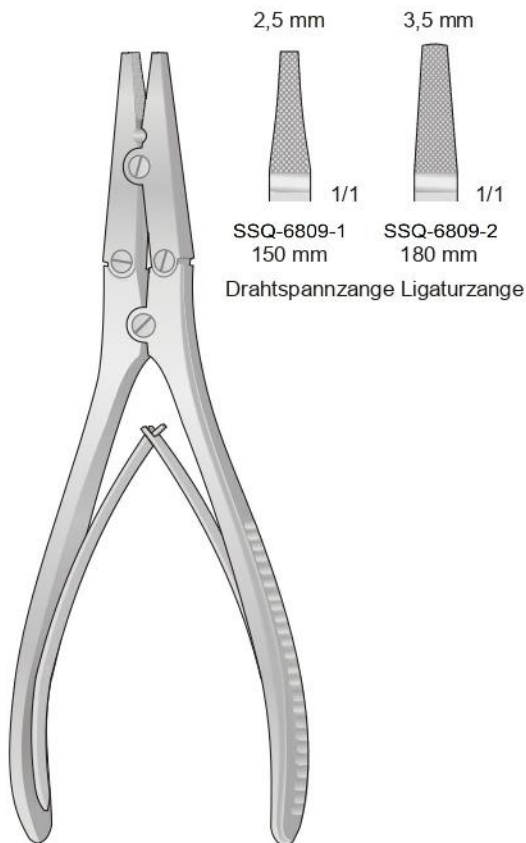

SSQ-6809

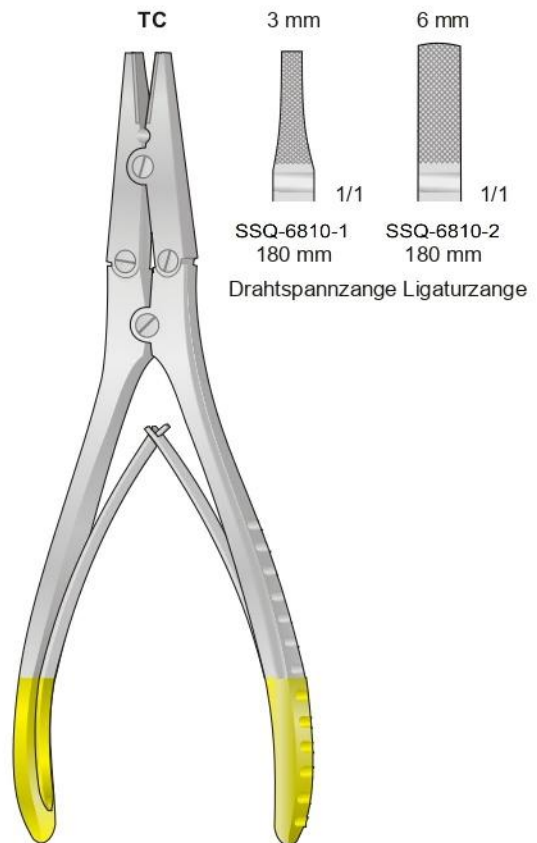

SSQ-6810

Per fili duri di  $\varnothing$  0,4 mm - For hard wire with  $\varnothing$  0,4 mm  
Für harten Draht bis  $\varnothing$  0,4 mm - Pour fils durs avec  $\varnothing$  0,4 mm  
Para hilos duros de  $\varnothing$  0,4 mm

Per filo duro  $\varnothing$  1 mm - Für harten draht  $\varnothing$  1 mm  
For hard wire  $\varnothing$  1 mm - Pour fil dur avec  $\varnothing$  1 mm  
Para alambres duro  $\varnothing$  1 mm

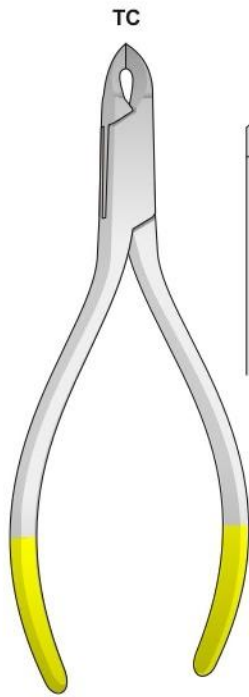

ANGLE  
SSQ-6811  
130 mm

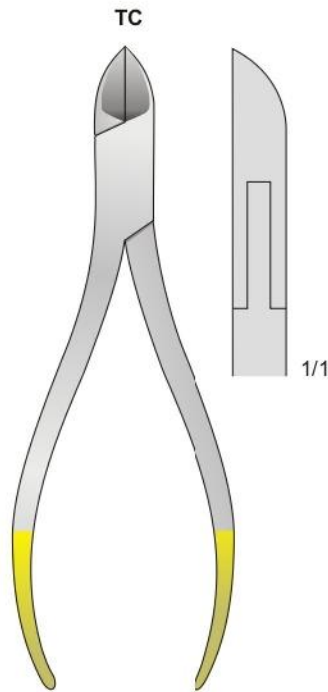

SSQ-6812  
130 mm

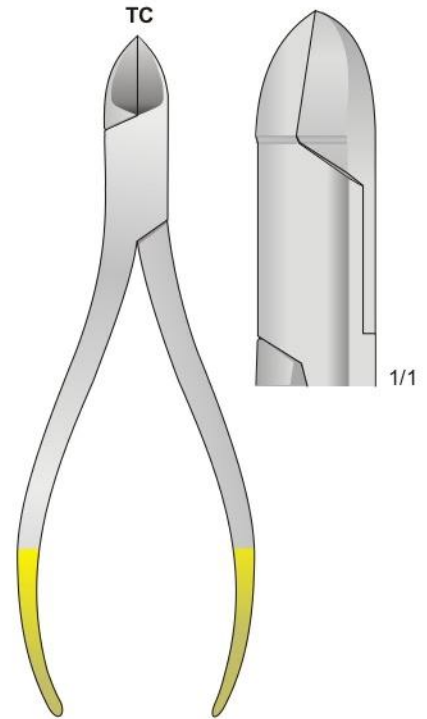

SSQ-6813  
150 mm

Per filo duro  $\varnothing$  1 mm - Für harten draht  $\varnothing$  1 mm  
For hard wire  $\varnothing$  1 mm - Pour fil dur avec  $\varnothing$  1 mm  
Para alambres duro  $\varnothing$  1 mm

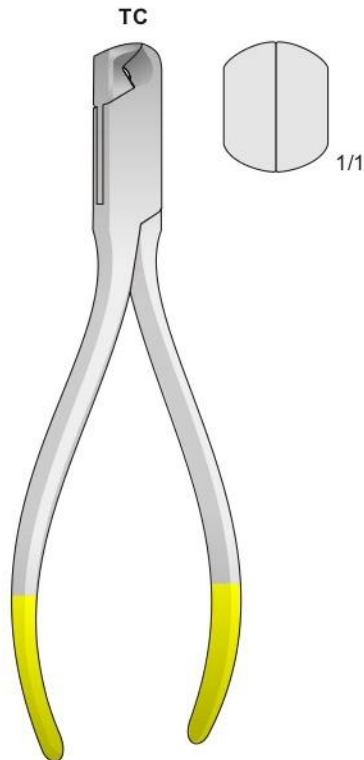

SSQ-6814  
145 mm

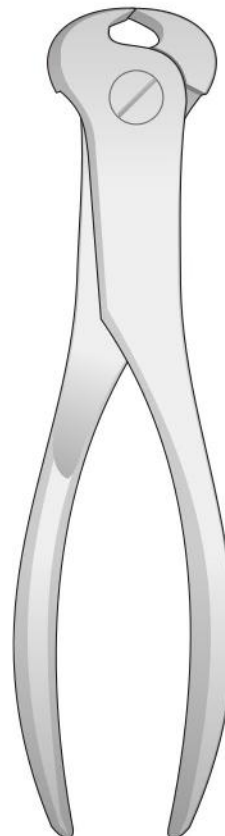

SSQ-6815  
185 mm

Port'aghi, pinze per fili d'acciaio  
Needle holders, wire forceps  
Nadelhalter, Draht-zangen  
Porte aiguilles, pinces à saisir  
Porta agujas, pinzas para hilos

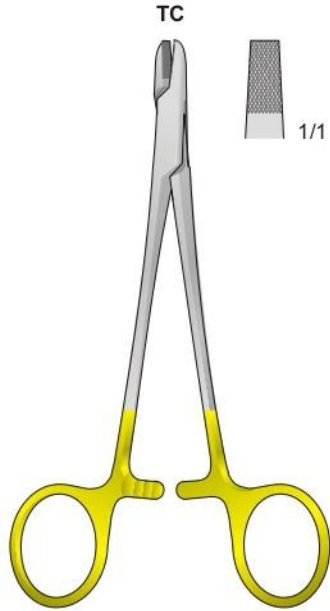

SSQ-6816  
150 mm

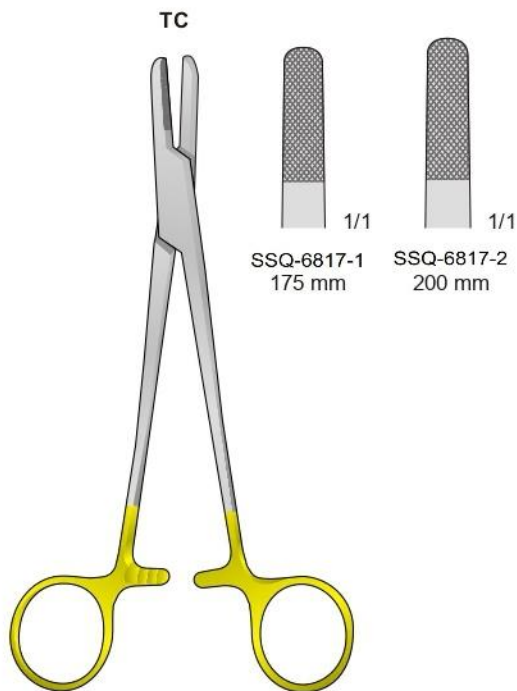

SSQ-6817

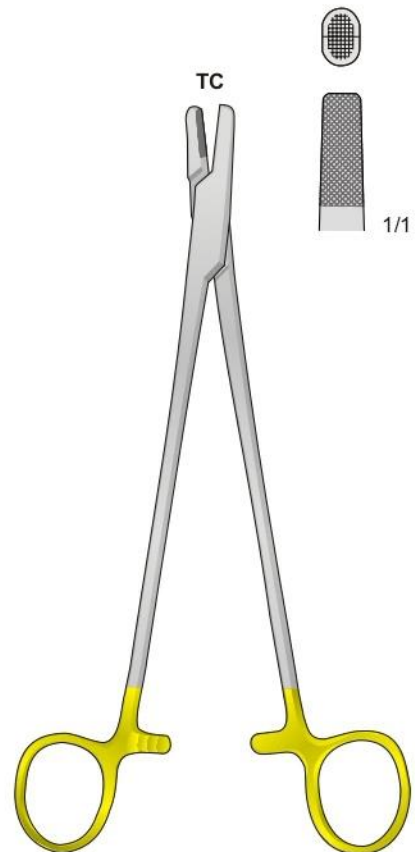

BAUMGARTNER  
SSQ-6818  
200 mm

Forbice universale dentellata - Draht-und Blehschere gezahnt  
Wire cutting scissor serrated - Ciseaux à couper les fils métalliques  
Tijeras para cortar hilo de acero dentadas

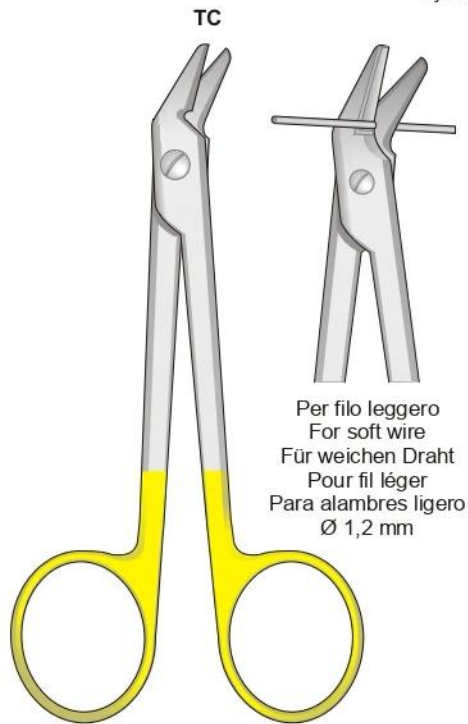

SSQ-6819  
120 mm

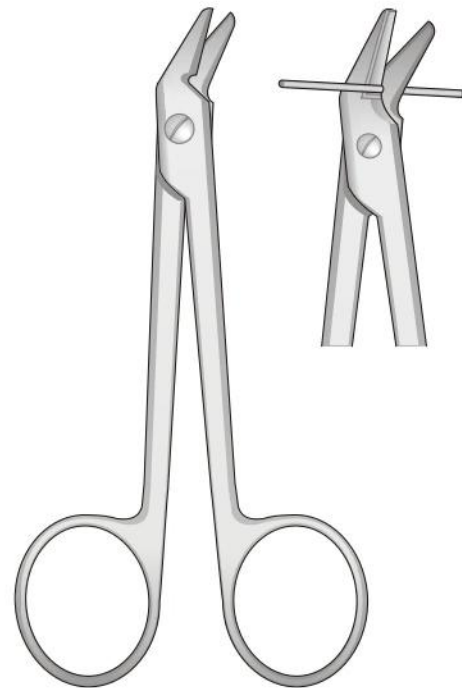

SSQ-6820  
120 mm

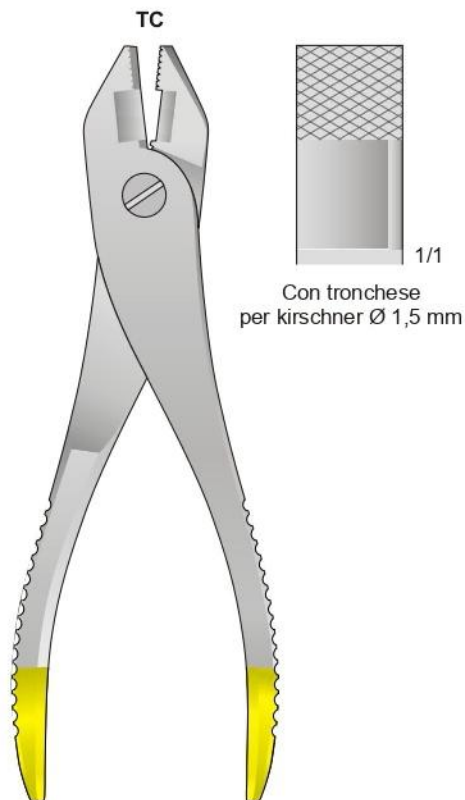

SSQ-6821  
220 mm

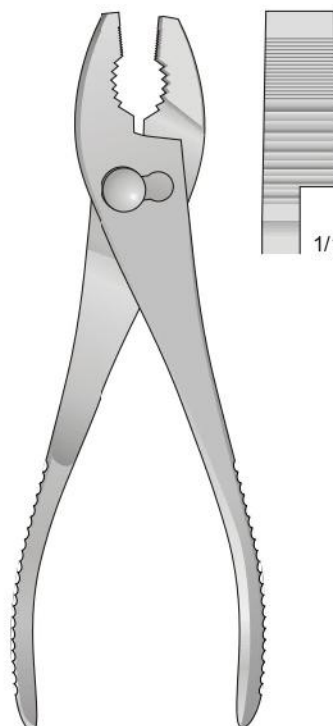

SSQ-6822  
200 mm

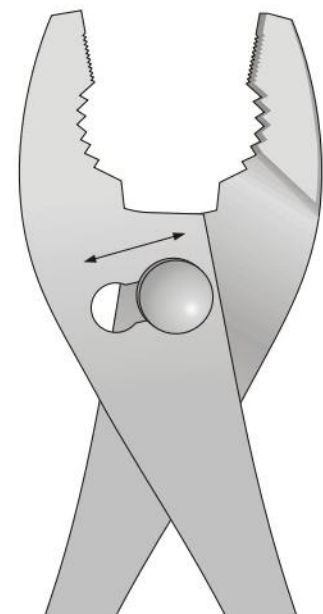

Per filo leggero Ø 2 mm  
 Per filo duro Ø 1,5 mm  
 For soft wire Ø 2 mm  
 For hard wire Ø 1,5 mm  
 Für weichen Draht Ø 2 mm  
 Für harten Draht Ø 1,5 mm  
 Pour fil léger Ø 2 mm  
 Pour fil dur Ø 1,5 mm  
 Para alambres ligero Ø 2 mm  
 Para alambres duro Ø 1,5 mm

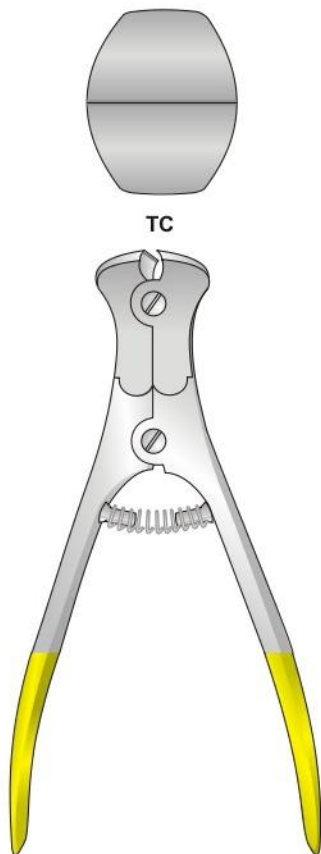

SSQ-6823  
145 mm

Per filo leggero Ø 2 mm  
 Per filo duro Ø 1,6 mm  
 For soft wire Ø 2 mm  
 For hard wire Ø 1,6 mm  
 Für weichen Draht Ø 2 mm  
 Für harten Draht Ø 1,6 mm  
 Pour fil léger Ø 2 mm  
 Pour fil dur Ø 1,6 mm  
 Para alambres ligero Ø 2 mm  
 Para alambres duro Ø 1,6 mm

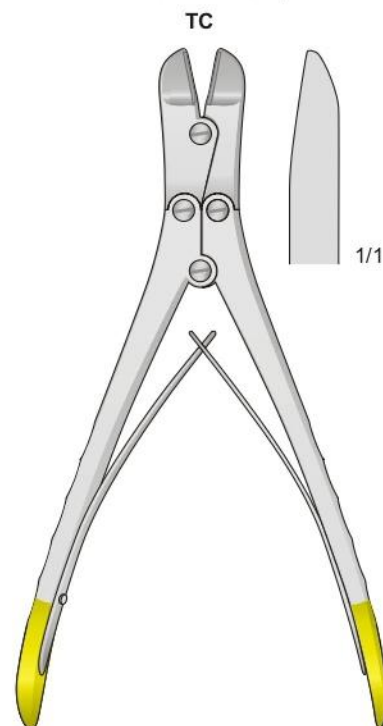

SSQ-6824  
170 mm

Per filo leggero Ø 3,5 mm  
 Per filo duro Ø 2,5 mm  
 For soft wire Ø 3,5 mm  
 For hard wire Ø 2,5 mm  
 Für weichen Draht Ø 3,5 mm  
 Für harten Draht Ø 2,5 mm  
 Pour fil léger Ø 3,5 mm  
 Pour fil dur Ø 2,5 mm  
 Para alambres ligero Ø 3,5 mm  
 Para alambres duro Ø 2,5 mm

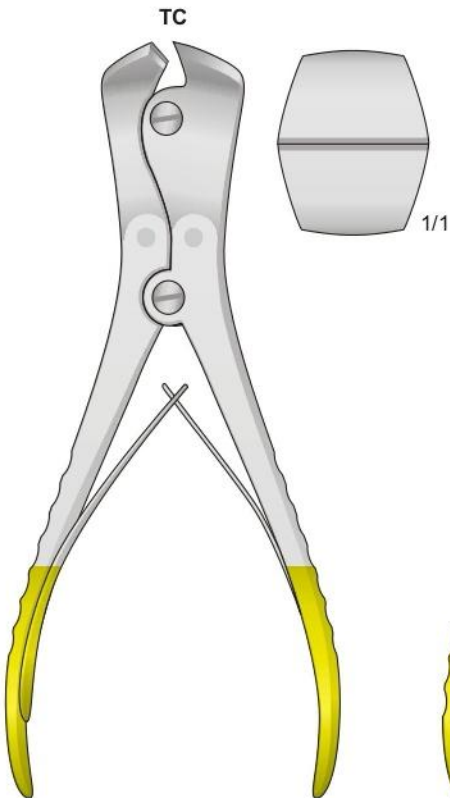

SSQ-6825  
215 mm

Per filo leggero Ø 3 mm  
 Per filo duro Ø 2,2 mm  
 For soft wire Ø 3 mm  
 For hard wire Ø 2,2 mm  
 Für weichen Draht Ø 3 mm  
 Für harten Draht Ø 2,2 mm  
 Pour fil léger Ø 3 mm  
 Pour fil dur Ø 2,2 mm  
 Para alambres ligero Ø 3 mm  
 Para alambres duro Ø 2,2 mm

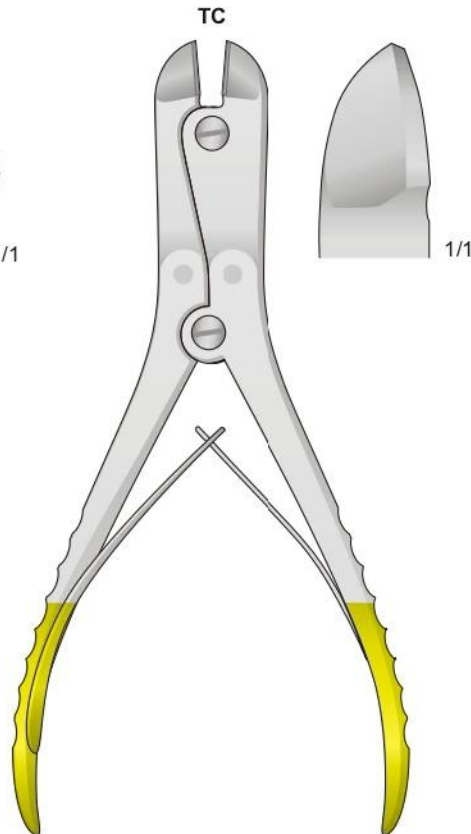

SSQ-6826  
230 mm

Per filo leggero Ø 2,5 mm  
 Per filo duro Ø 2 mm  
 For soft wire Ø 2,5 mm  
 For hard wire Ø 2 mm  
 Für weichen Draht Ø 2,5 mm  
 Für harten Draht Ø 2 mm  
 Pour fil léger Ø 2,5 mm  
 Pour fil dur Ø 2 mm  
 Para alambres ligero Ø 2,5 mm  
 Para alambres duro Ø 2 mm

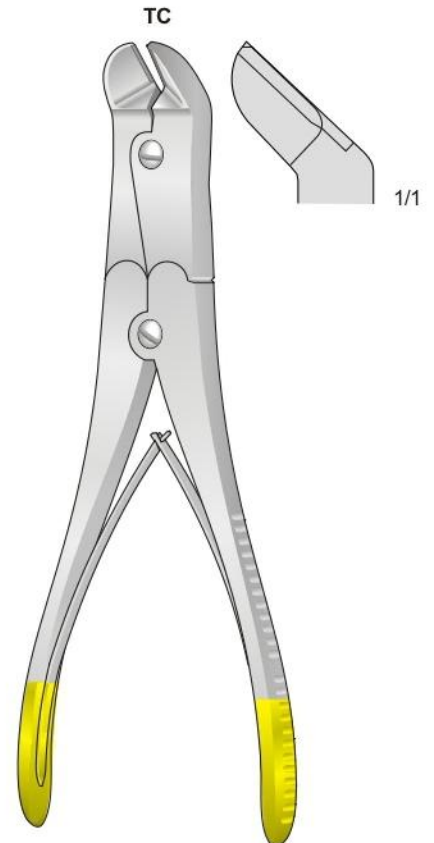

SSQ-6827  
230 mm

Per filo leggero Ø 7 mm  
Per filo duro Ø 6 mm  
For soft wire Ø 7 mm  
For hard wire Ø 6 mm  
Für weichen Draht Ø 7 mm  
Für harten Draht Ø 6 mm  
Pour fil léger Ø 7 mm  
Pour fil dur Ø 6 mm  
Para alambres ligero Ø 7 mm  
Para alambres duro Ø 6 mm

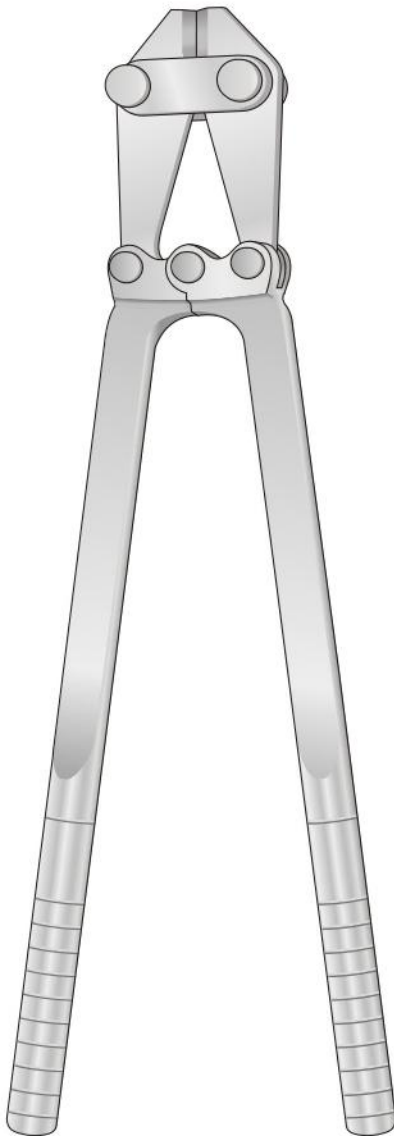

SSQ-6828  
480 mm

Per filo leggero Ø 7 mm  
Per filo duro Ø 6 mm  
For soft wire Ø 7 mm  
For hard wire Ø 6 mm  
Für weichen Draht Ø 7 mm  
Für harten Draht Ø 6 mm  
Pour fil léger Ø 7 mm  
Pour fil dur Ø 6 mm  
Para alambres ligero Ø 7 mm  
Para alambres duro Ø 6 mm

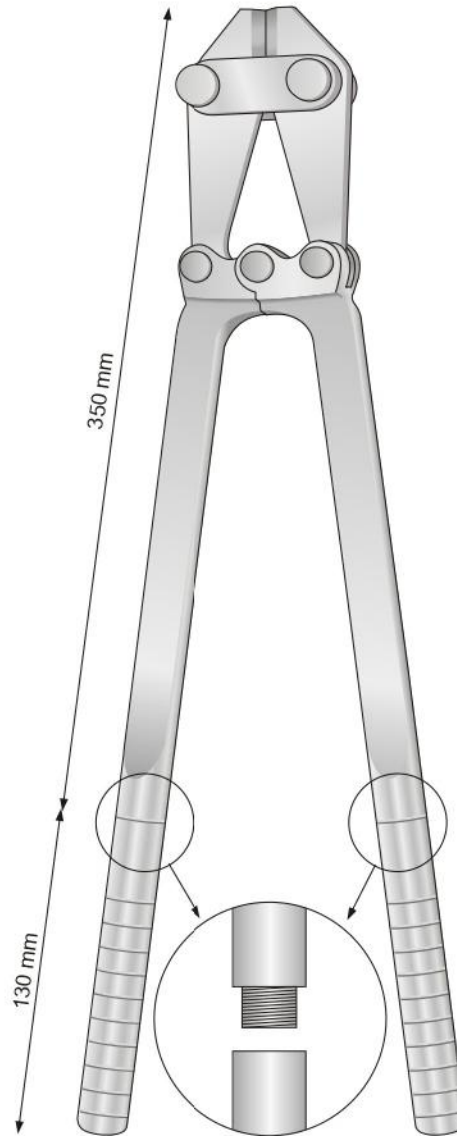

SSQ-6829  
480 mm

Per filo leggero Ø 5 mm  
Per filo duro Ø 4,5 mm  
For soft wire Ø 5 mm  
For hard wire Ø 4,5 mm  
Für weichen Draht Ø 5 mm  
Für harten Draht Ø 4,5 mm  
Pour fil léger Ø 5 mm  
Pour fil dur Ø 4,5 mm  
Para alambres ligero Ø 5 mm  
Para alambres duro Ø 4,5 mm

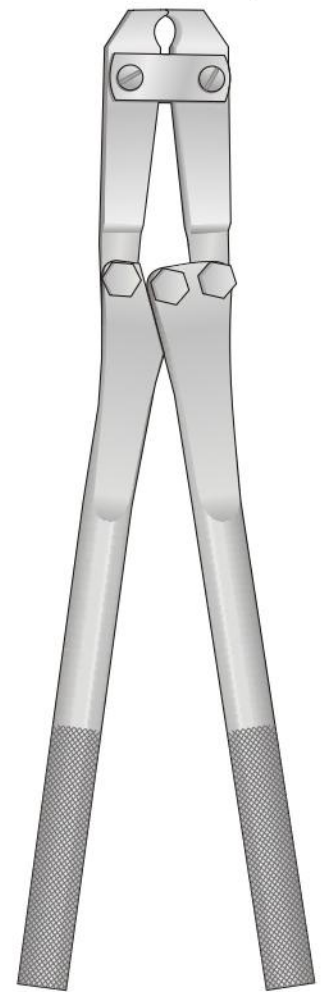

SSQ-6830  
375 mm



Misuratore per chiodi Kirschner  
Meßlehre für Kirschnerdrähte

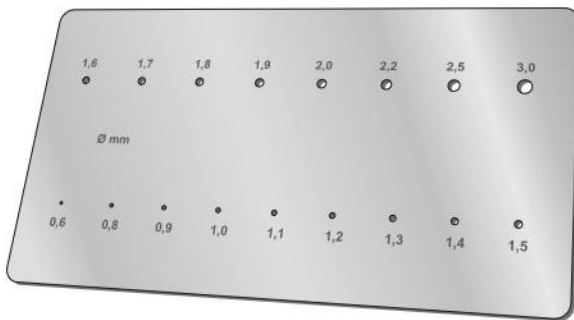

0,5 mm



SSQ-6831  
50 mm

0,5 mm



SSQ-6832  
120 mm

0,5 mm



SSQ-6833  
150 mm

0,5 mm



SSQ-6834  
300 mm

Misuratore di lunghezza per viti  
Screw depth gauges, to select proper length of screw  
Instruments de mesure de profondeur pour déterminer la longueur de vis requise

Per viti Ø  
For screw Ø  
Für Schrauben Ø  
Pour vis de Ø



SSQ-6835  
165 mm

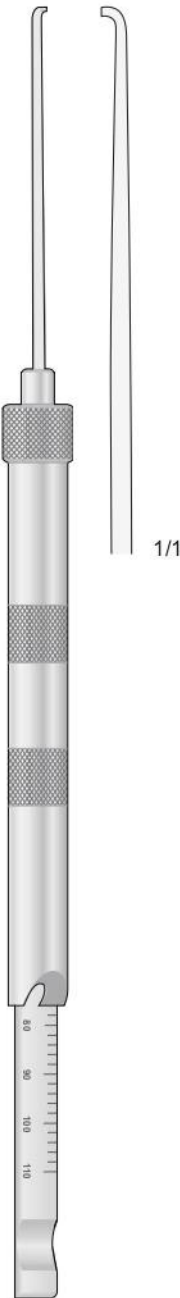

SSQ-6836  
265 mm

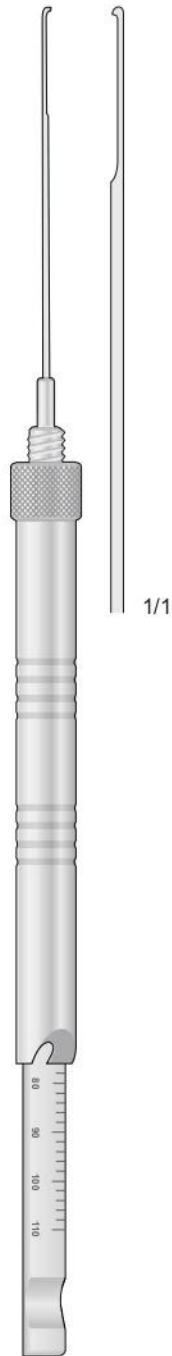

SSQ-6837  
280 mm

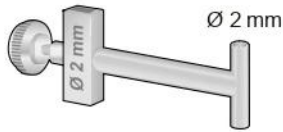

SSQ-6838-2

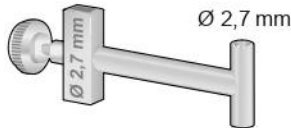

SSQ-6838-3

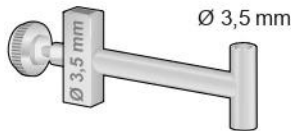

SSQ-6838-4

Centrapunte  
Manicotto dentato  
Steckbohrbüchsen  
Insert-drill

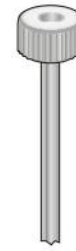

Ø Esterno      Ø Per punte  
Ø Outside      Ø For drills  
Ø Außen        Ø Für Bohrer  
Ø Extérieur    Ø Pour Mèches  
Ø Exterior      Ø Para agujas

Cod. Art.	Ø Esterno	Ø Per punte
SSQ-6839-1	4,5 mm	3,2 mm
SSQ-6839-2	3,5 mm	2 mm
SSQ-6839-3	3,5 mm	2,7 mm

Guida per punte elicoidali  
Gewebeschützülzen

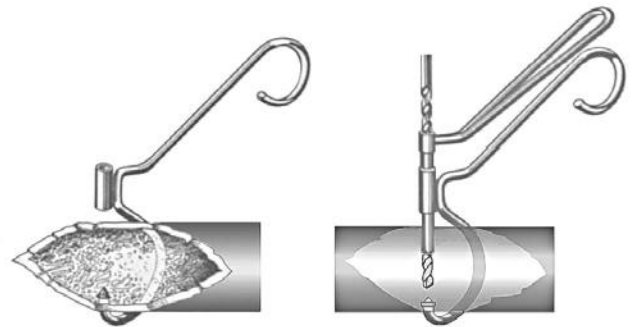

12-1940-05  
Completo di 3 guide

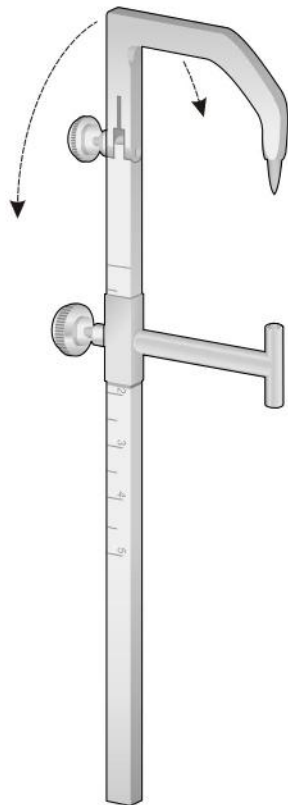

SSQ-6838  
145 mm

12-1940-01  
Centratore solo

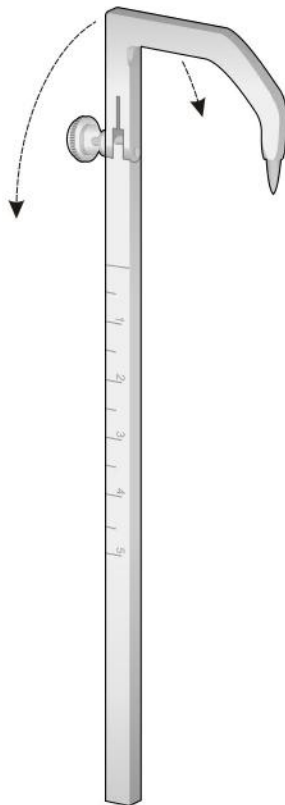

SSQ-6838-1  
145 mm

Interno Ø 6,5 mm  
Inside Ø 6,5 mm  
Innen Ø 6,5 mm  
Intérieur Ø 6,5 mm  
Interior Ø 6,5 mm

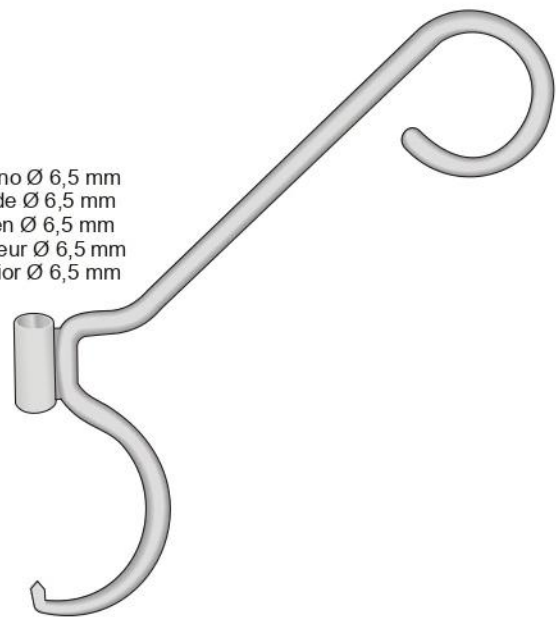

SSQ-6839

Attacco Dentale  
Dental schaft

Ø 1,5 mm



SSQ-6840-9  
50 mm

Ø 2,0 mm



SSQ-6840-10  
55 mm

Attacco AO  
Mit AO schaft

Ø 1,5 mm



SSQ-6840-1  
65 mm

Ø 2 mm



SSQ-6840-2  
70 mm

Ø 2,7 mm



SSQ-6840-3  
100 mm

Passo della vite  
a 1,25 mm

Ø 3,5 mm



SSQ-6840-4  
110 mm

Passo della vite  
a 1,75 mm

Ø 3,5 mm



SSQ-6840-5  
110 mm

Ø 4,5 mm



SSQ-6840-6  
130 mm

Ø 4,5 mm



SSQ-6840-7  
130 mm

Ø 6,5 mm



SSQ-6840-8  
170 mm

Punte elicoidali con innesto rapido

Attacco AO  
Mit AO schaft  
Drill bits

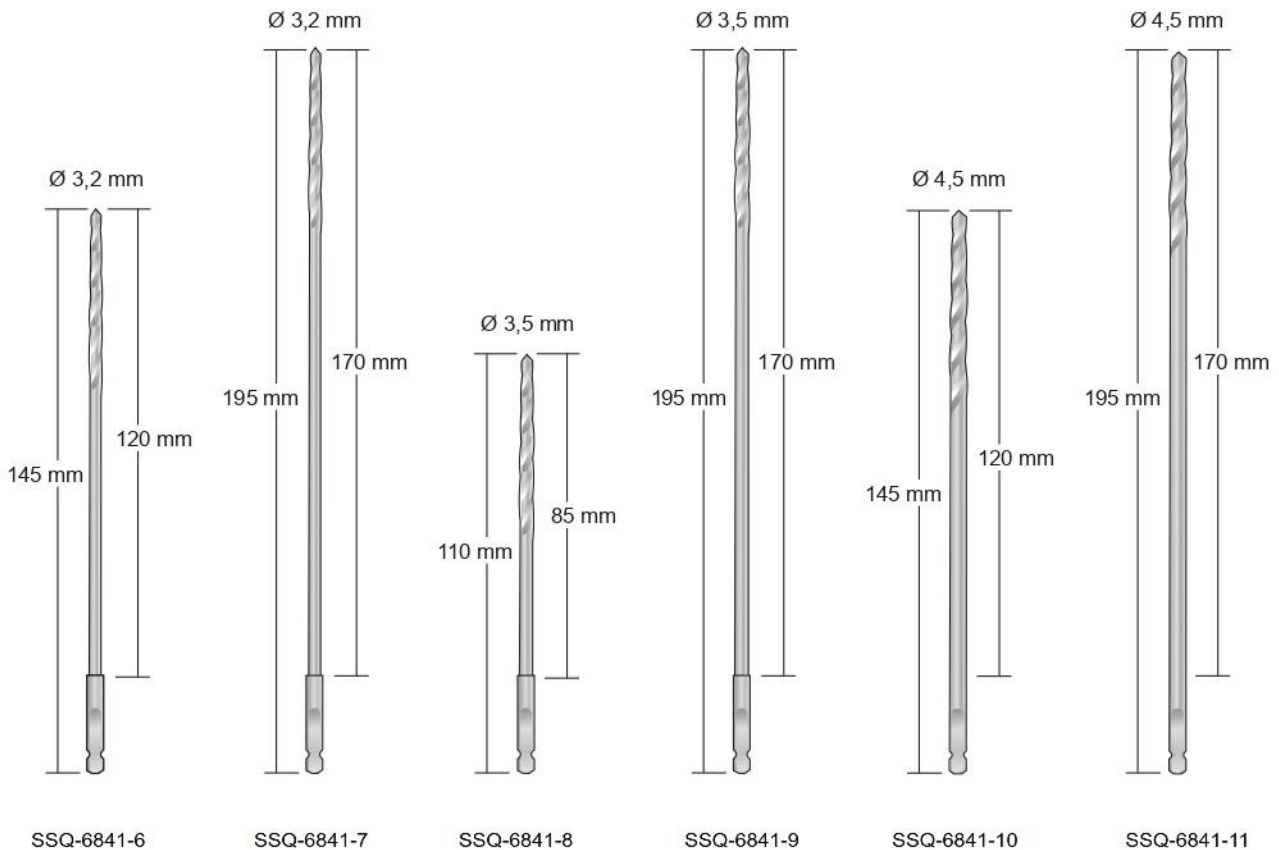
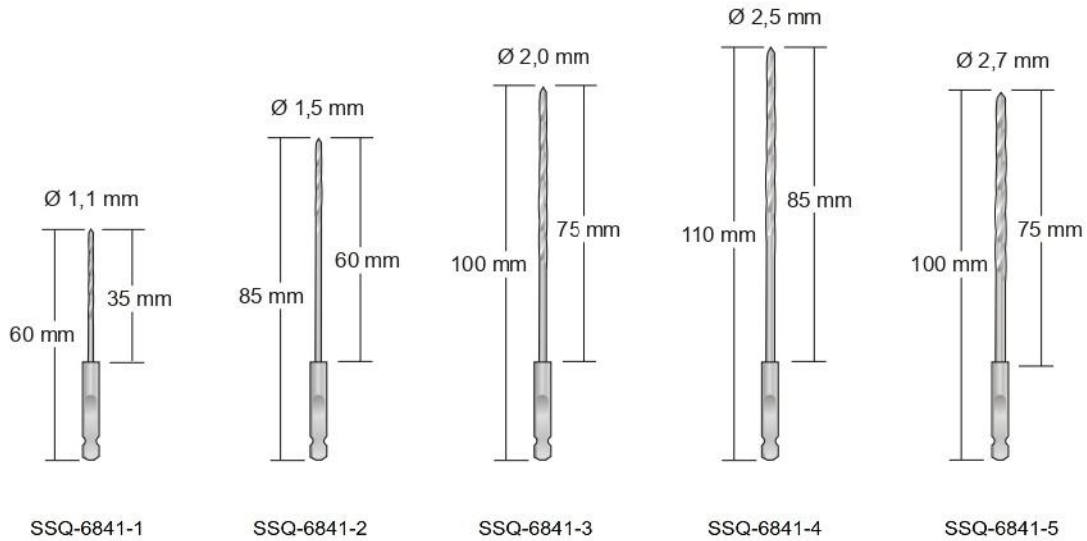

Punte elicoidali

Con attacco rotondo  
Mit rundschaft  
Drill bits

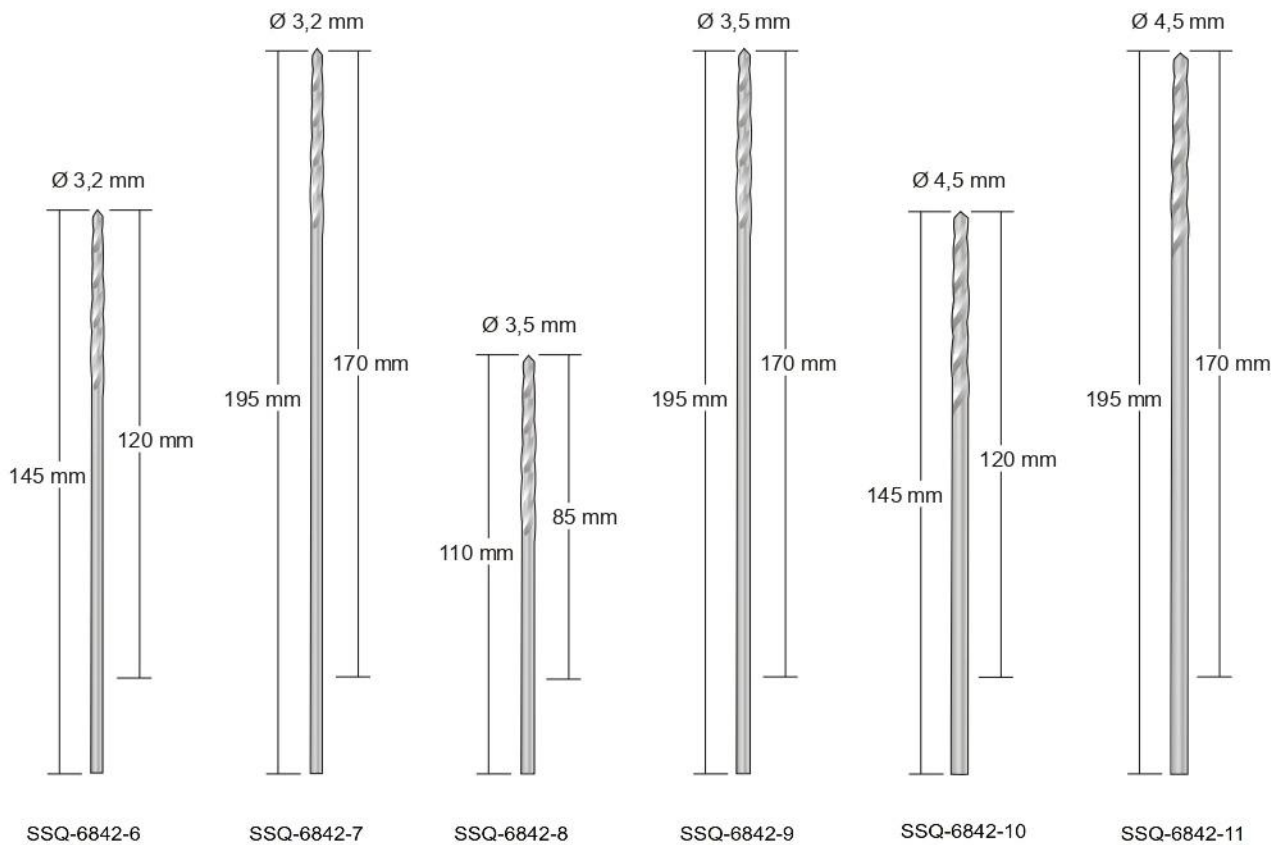
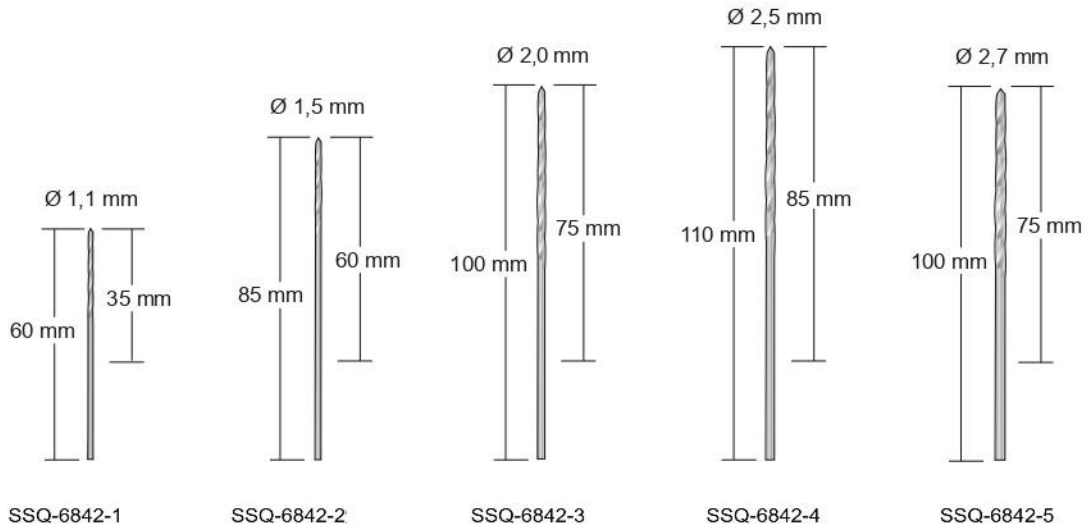

Per mini viti  
For mini-screws  
Für Mini-Schrauben  
Pour mini vis

1,5 mm



SSQ-6843-1  
55 mm

1,1 mm



SSQ-6843-2  
55 mm

Per piccole viti  
For small screws  
Für kleine Schrauben  
Pour petite vis

2,0 mm

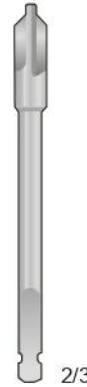

SSQ-6843-3  
70 mm

Per viti malleolari  
For malleolar screws  
Für Malleolarschrauben  
Pour vis à malléole

3,2 mm

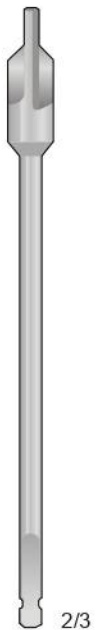

SSQ-6843-4  
120 mm

2,5 mm

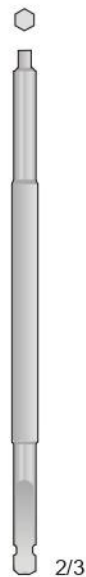

SSQ-6844-1  
100 mm

3,5 mm

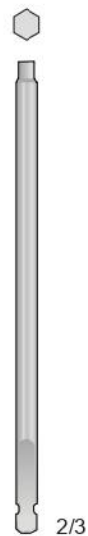

SSQ-6844-2  
90 mm

Reamer with end forquick coupling  
Zapfenfräser mit Schnellkupplung  
Fraise avec raccord rapide

Ø 4,5 mm

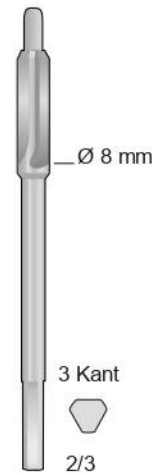

SSQ-6844-3  
90 mm

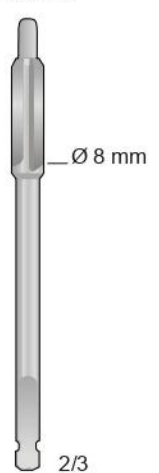

SSQ-6844-4  
90 mm

Manico con mandrino rapido  
Handles with quick-action chuck  
Handgriffe mit schnellspann futter  
Poignées avec mandrins rapides

Ø 4 mm

AO-Schaft



Dental-Schaft



4kant-Schaft

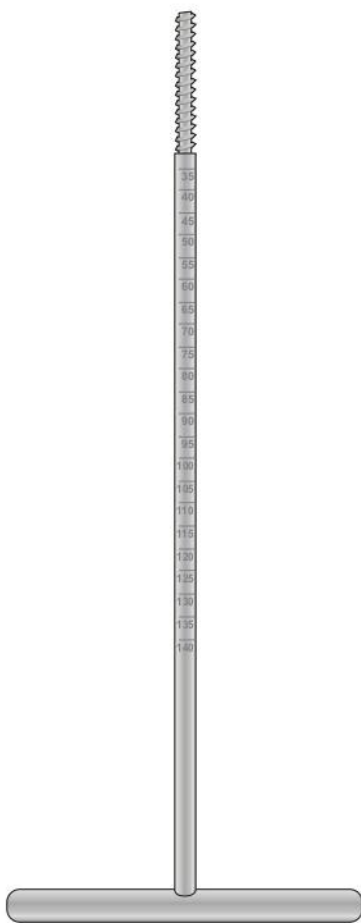

SSQ-6844  
260 mm



MANICO FERROZELL  
SSQ-6845  
125 mm



SSQ-6846  
110 mm

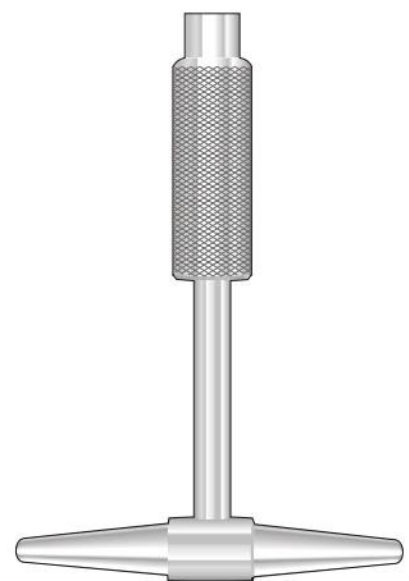

SSQ-6847  
80 mm



Centratori guida punte - Drill guides - Bohrbüchsen zu Knochenplatten - Guide méche

Per trapano Ø 2 mm

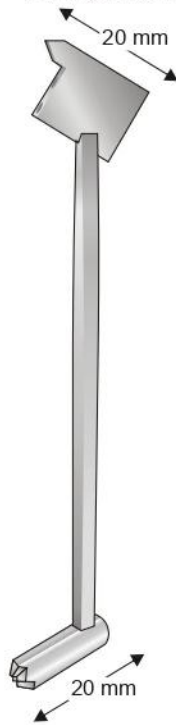

SSQ-6848  
110 mm

Per viti da corticale Ø 3,5 mm  
Per maschiatore Ø 2,5 mm



SSQ-6849

Per viti da corticale Ø 6,5 mm  
Per maschiatore Ø 3,2 mm



SSQ-6850

Per trapano Ø 1,1/1,5 mm

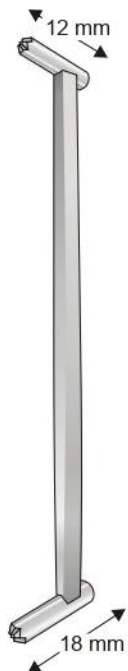

SSQ-6851  
105 mm

Per trapano Ø 2,5 mm  
Per viti da corticale Ø 3,5 mm  
Per maschiatore Ø 3,5 mm

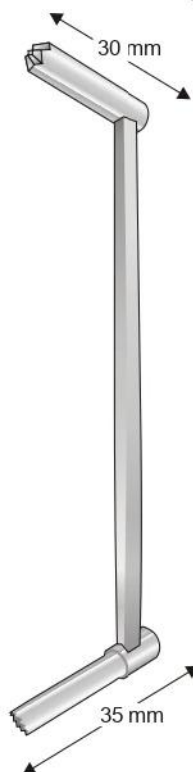

SSQ-6852  
125 mm

Per viti da corticale Ø 4,5 mm  
Per maschiatore Ø 3,2 mm

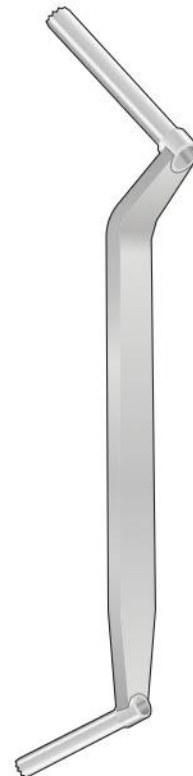

SSQ-6853

Centratori guida punte - Drill guides - Bohrbüchsen zu Knochenplatten - Guide méche

**Codificazione del colore**

verde = centrico  
oro = eccentrico

Per trapano Ø 2,0 mm  
Per viti da corticale Ø 2,7 mm

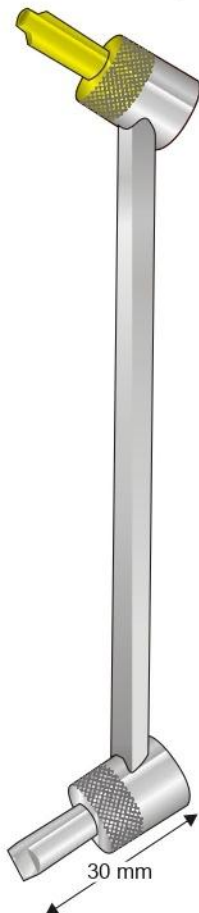

SSQ-6854  
140 mm

Per trapano Ø 2,5 mm  
Per viti da corticale Ø 3,5 mm

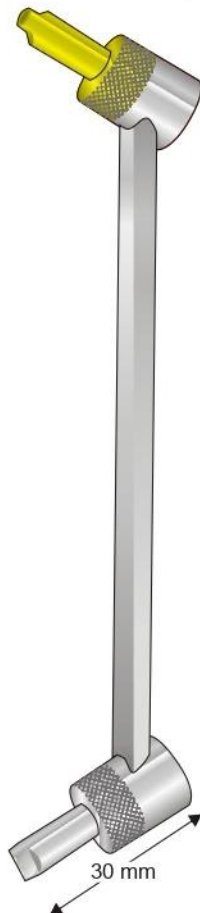

SSQ-6855  
140 mm

Per trapano Ø 3,2 mm  
Per viti da corticale Ø 4,5 mm

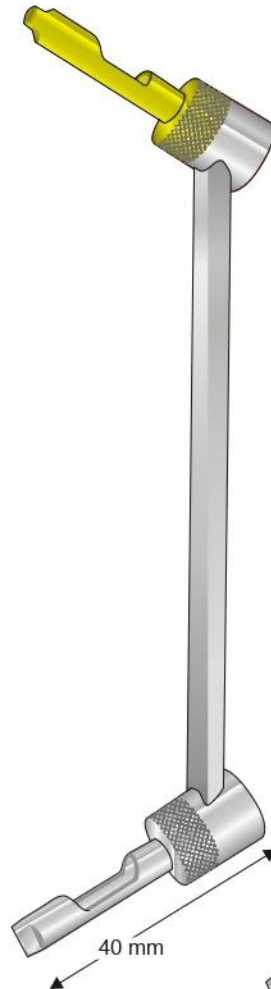

SSQ-6856  
165 mm

Per trapano Ø 3,2 mm  
Per viti da corticale Ø 4,5 mm

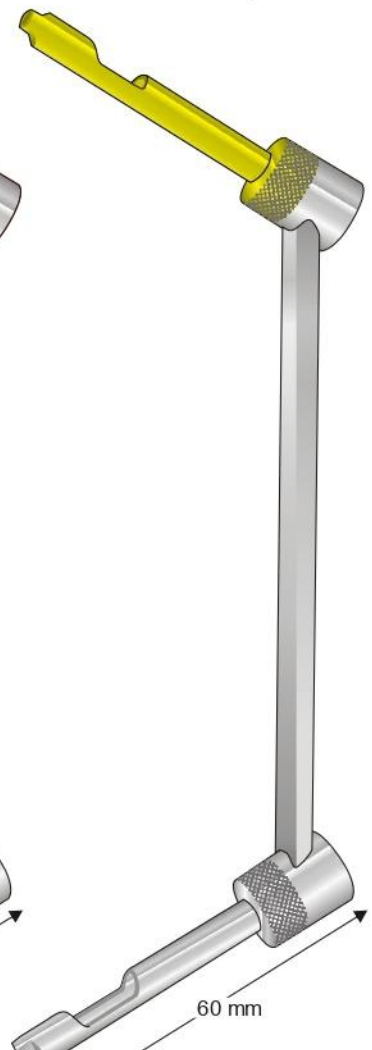

SSQ-6857  
170 mm

Centratori guida punte - Drill guides - Bohrbüchsen zu Knochenplatten - Guide méche

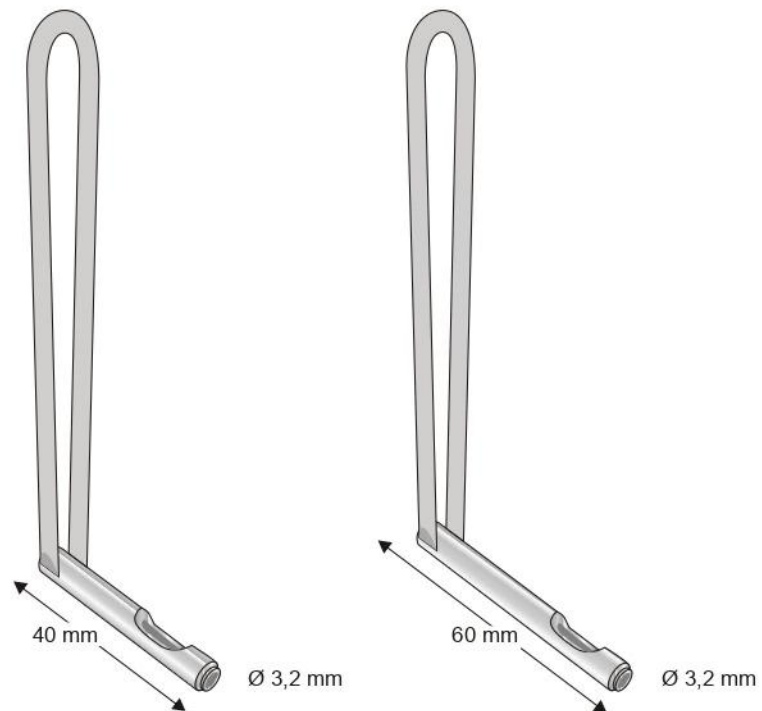

SSQ-6858-1  
125 mm

SSQ-6858-2  
125 mm

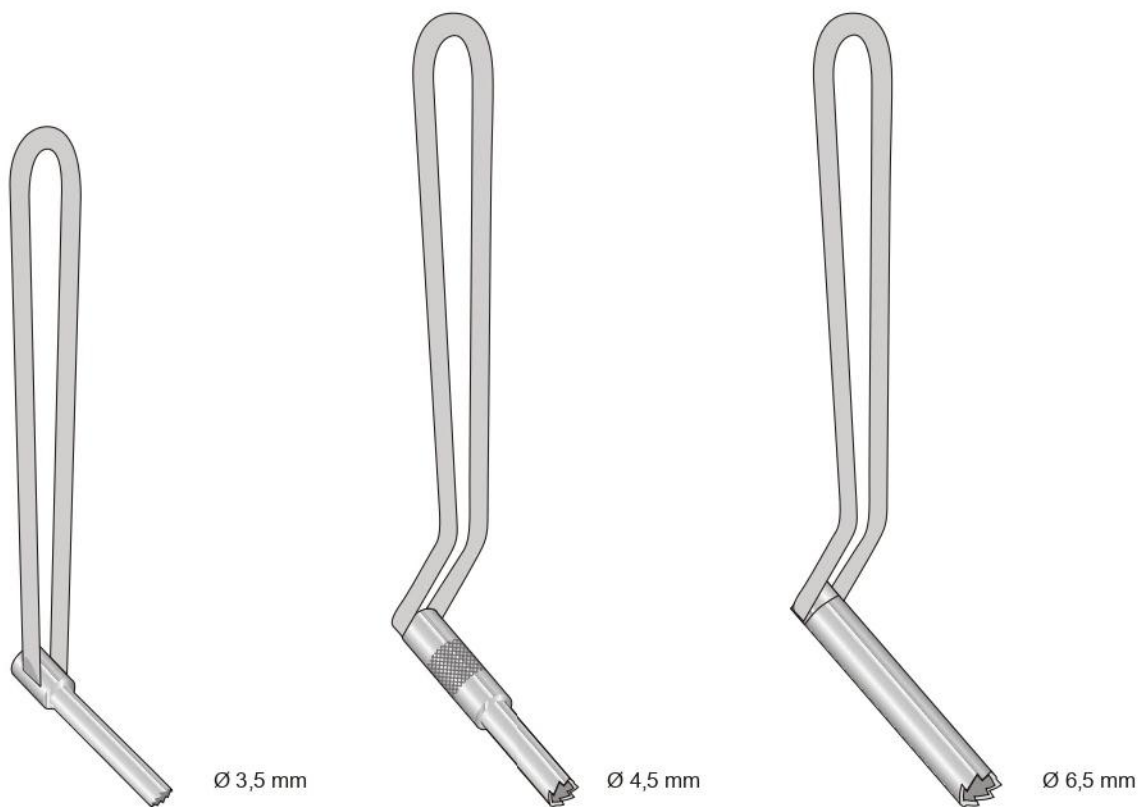

SSQ-6858-3  
125 mm

SSQ-6858-4  
150 mm

SSQ-6858-5  
150 mm

Scatola con set giraviti - Box with screws driver - Schraubenzieher, Set mit Etui  
Jeu de tournevis, en boîte - Set destornilladores

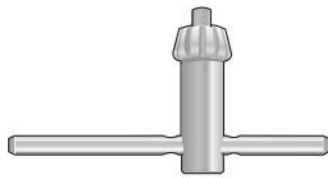
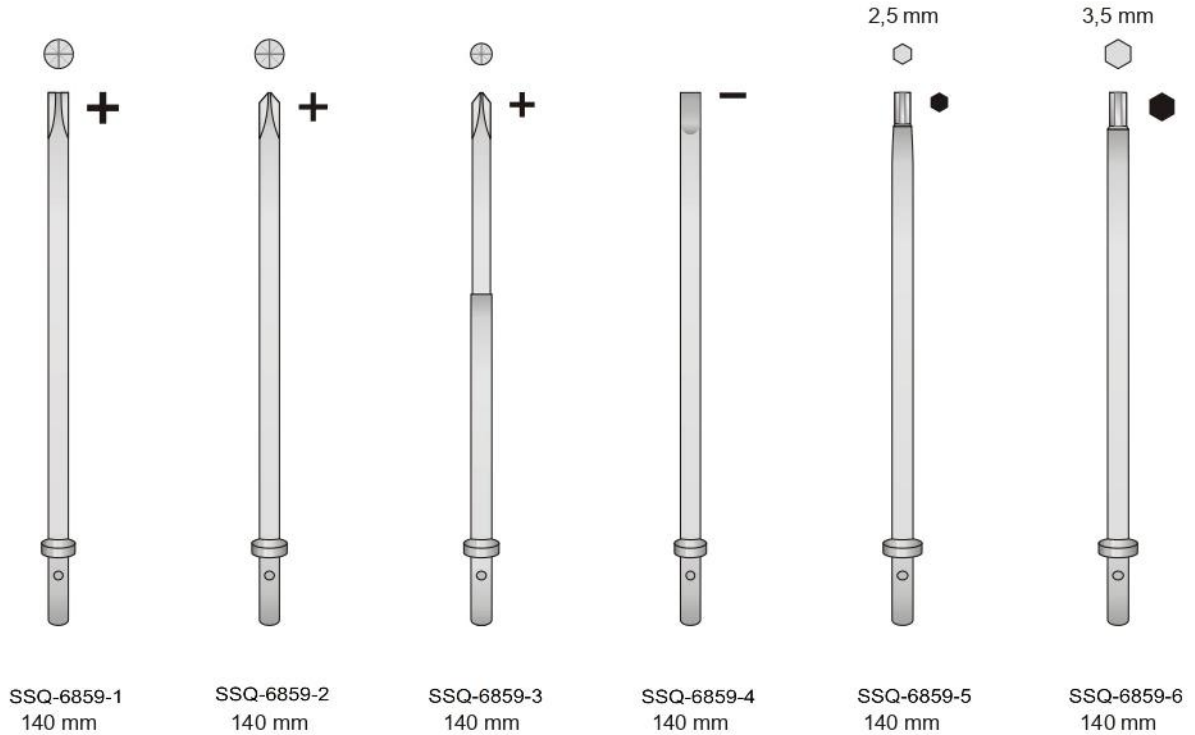

SSQ-6860  
32 mm



SSQ-6861  
145 mm

Max. Ø 6,3 mm



UNIVERSAL  
SSQ-6862  
75 mm

Scatola con set giraviti - Completo  
Box with screws driver - Complete  
Schraubenzieher, Set mit Etui - Komplett  
Jeu de tournevis, en boîte - Complete  
Set destornilladores - Completos



Solo scatola

SSQ-6863  
200x100x40 mm

Giraviti - Screws driver - Schraubenzieher - Jeu de tournevis - Destornilladores

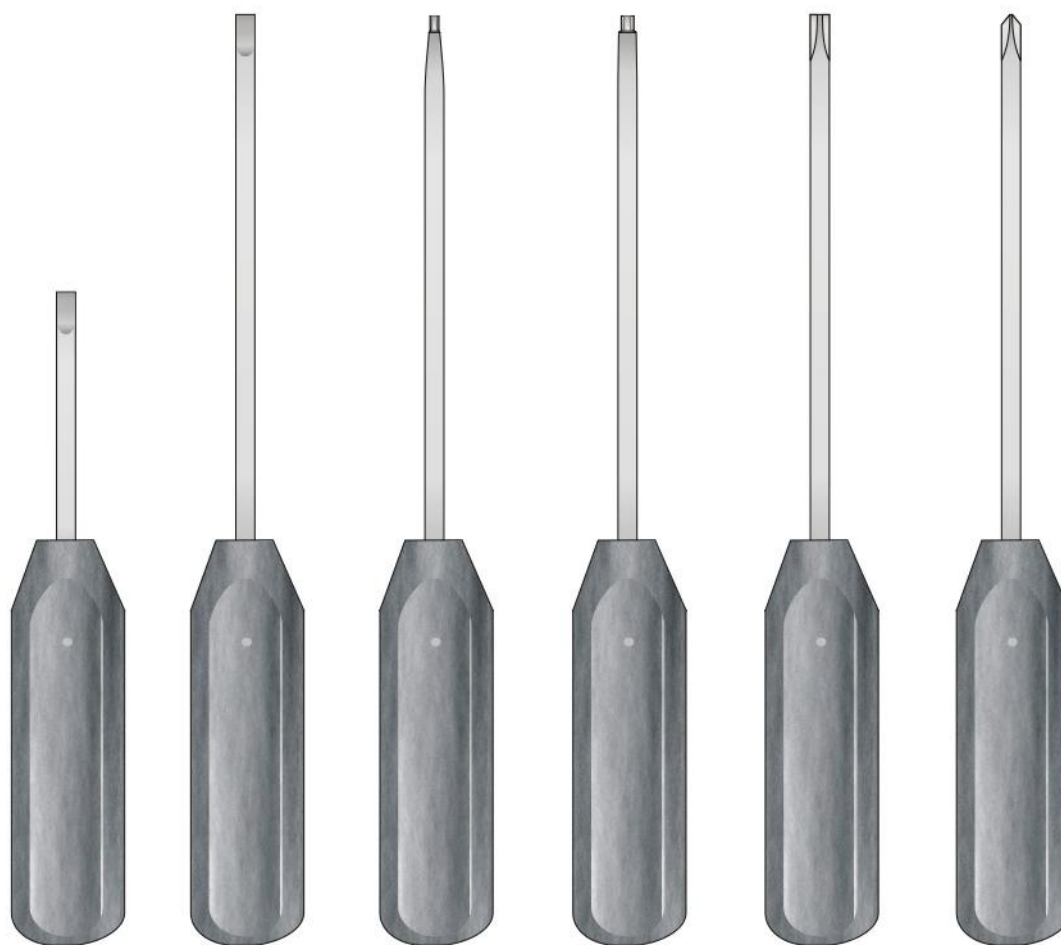
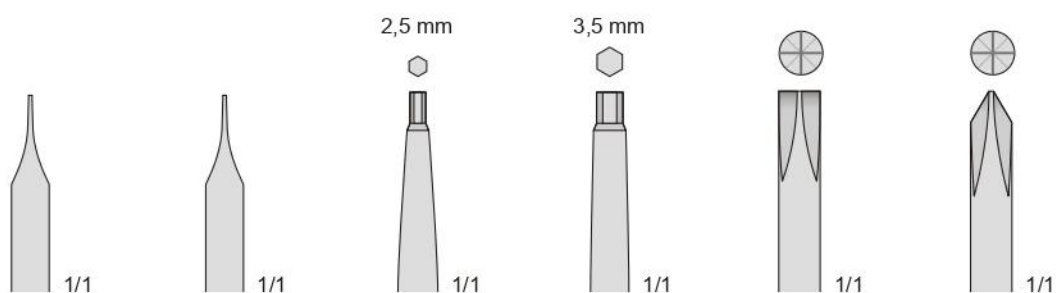

SSQ-6864-1  
170 mm

LANE  
SSQ-6864-2  
250 mm

SSQ-6864-3  
250 mm

SSQ-6864-4  
250 mm

SSQ-6864-5  
250 mm

PHILIPS  
SSQ-6864-6  
250 mm

Giraviti - Screws driver - Schraubenzieher - Jeu de tournevis - Destornilladores

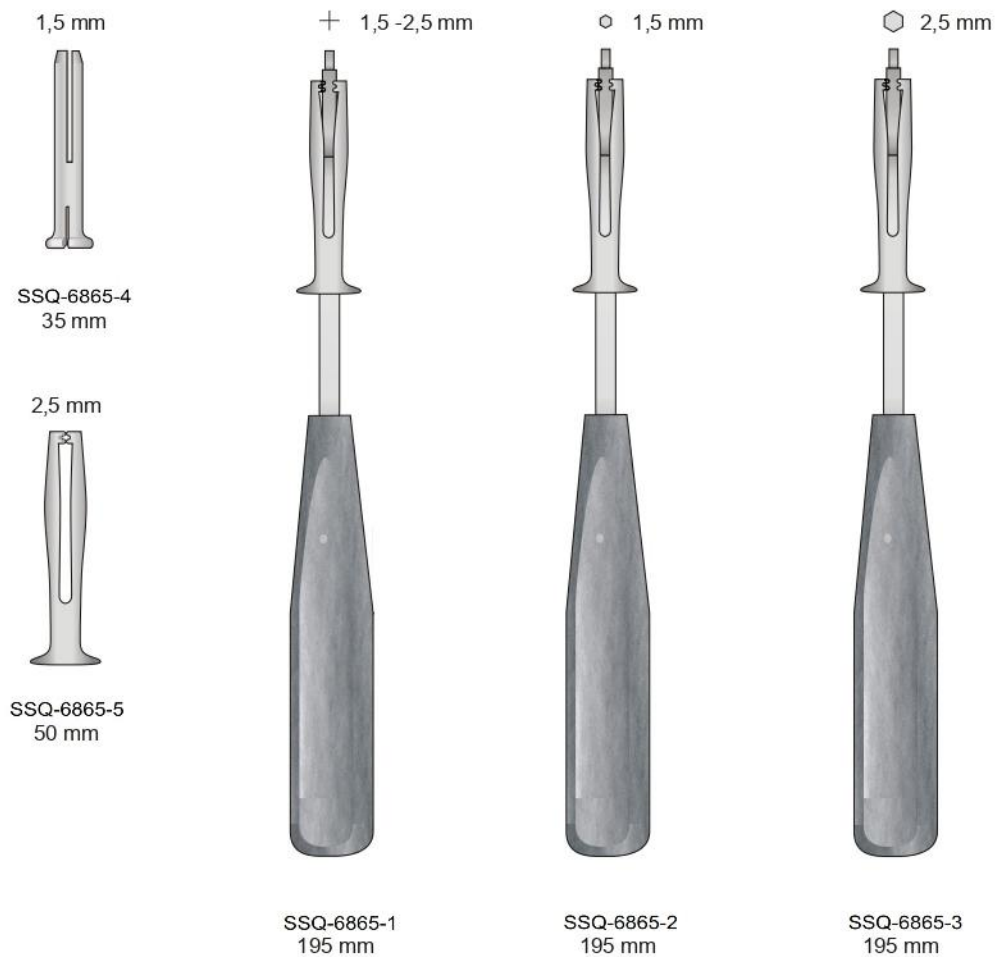

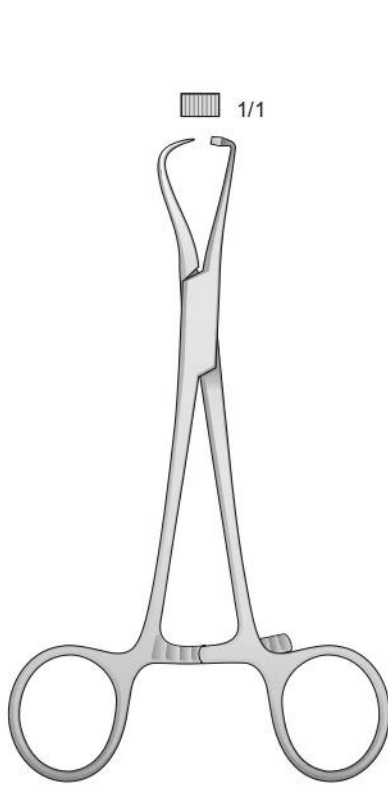

SSQ-6866  
120 mm

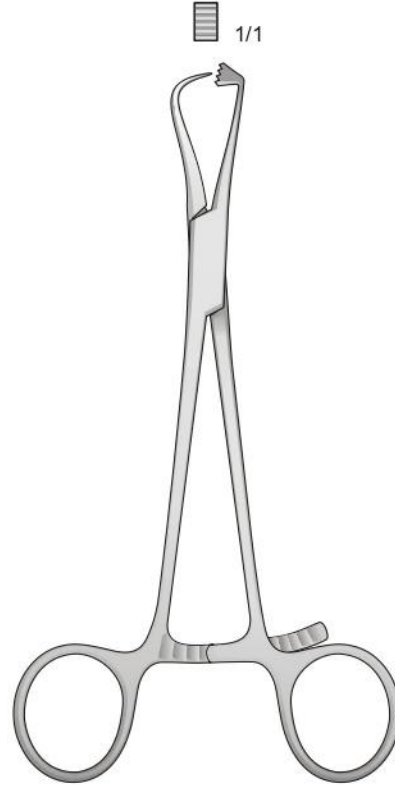

SSQ-6867  
125 mm

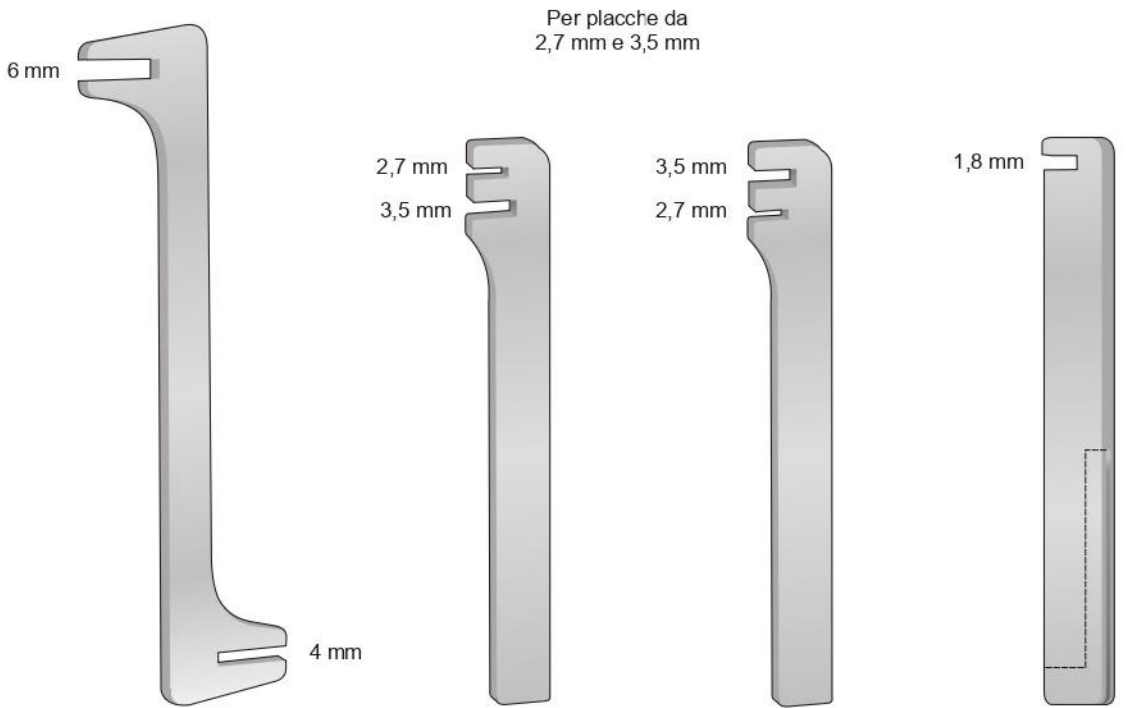

Per placche da  
2,7 mm e 3,5 mm

6 mm

2,7 mm  
3,5 mm

3,5 mm  
2,7 mm

1,8 mm

4 mm

SSQ-6868  
180 mm

SSQ-6868-1 100 mm  
SSQ-6868-2 140 mm

SSQ-6868-3 100 mm  
SSQ-6868-4 140 mm

SSQ-6868-5  
100 mm

Pinze piegaplacche - Bending pliers - Biegezange - Pincés à plier

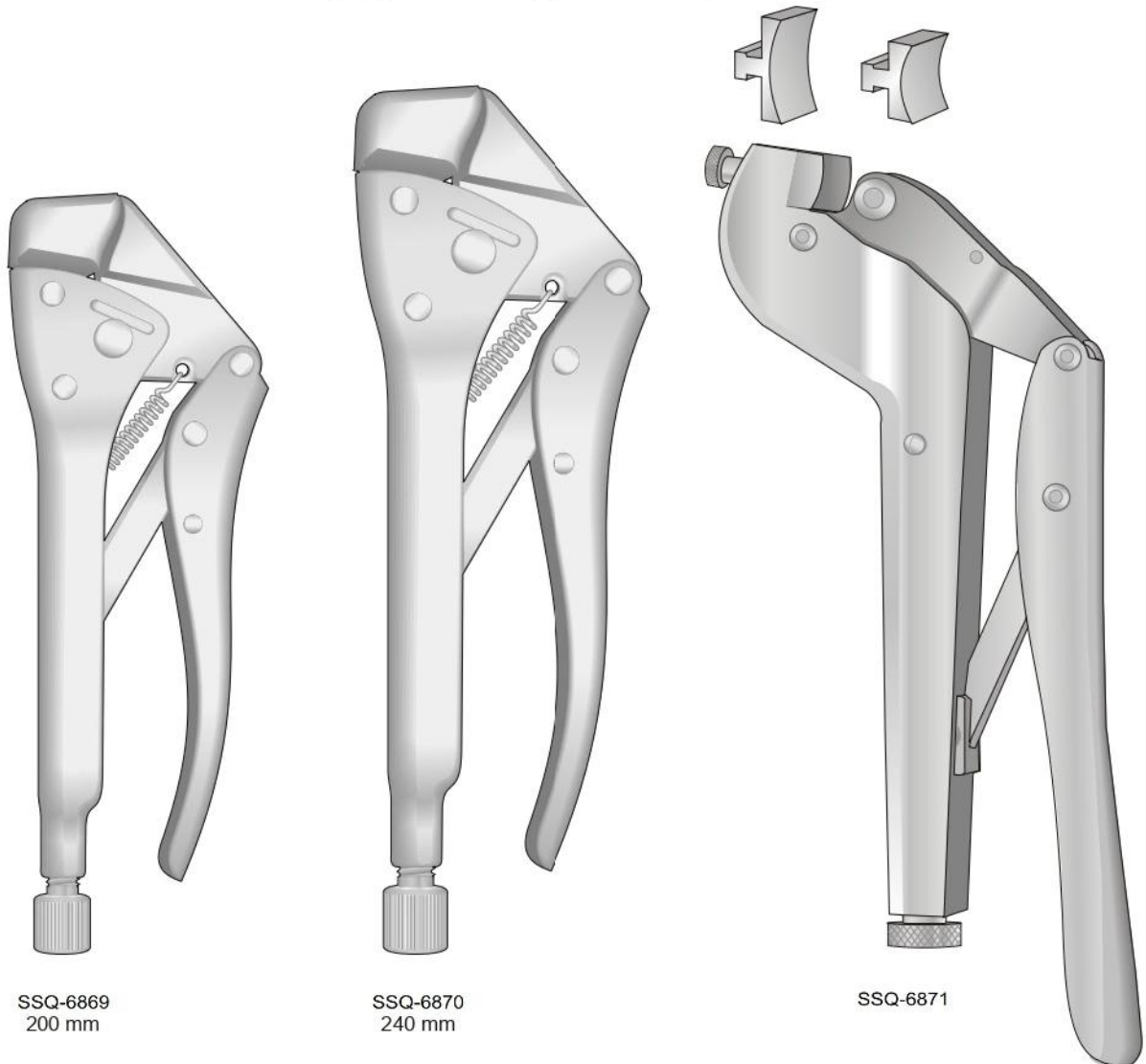

Pressa piegaplacche - Bending press - Biegepresse - Presse pour plier

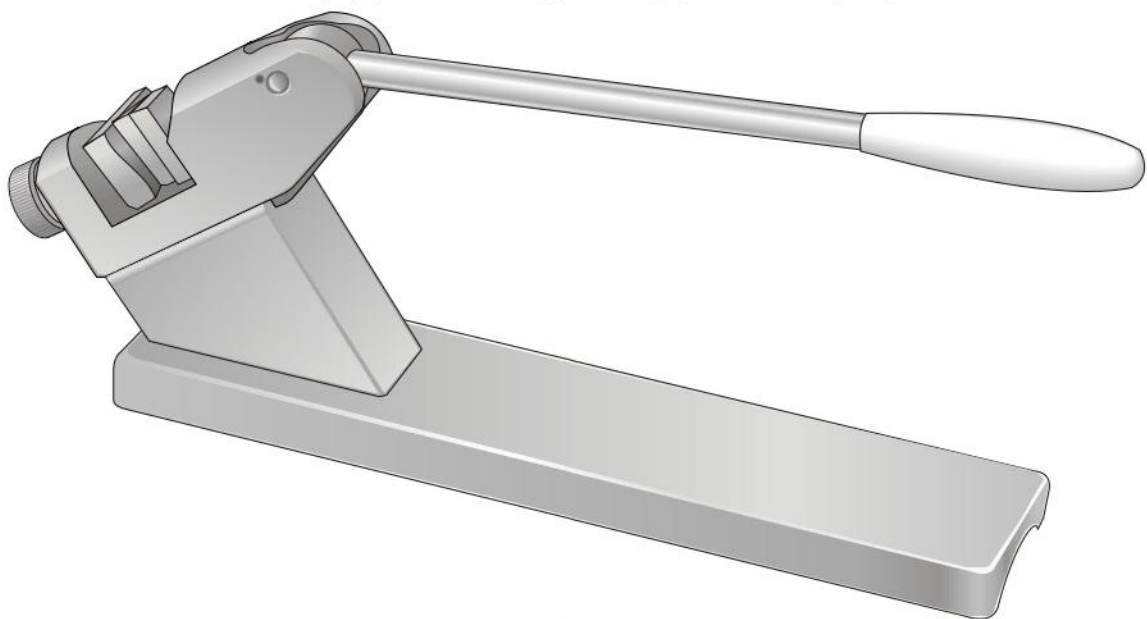



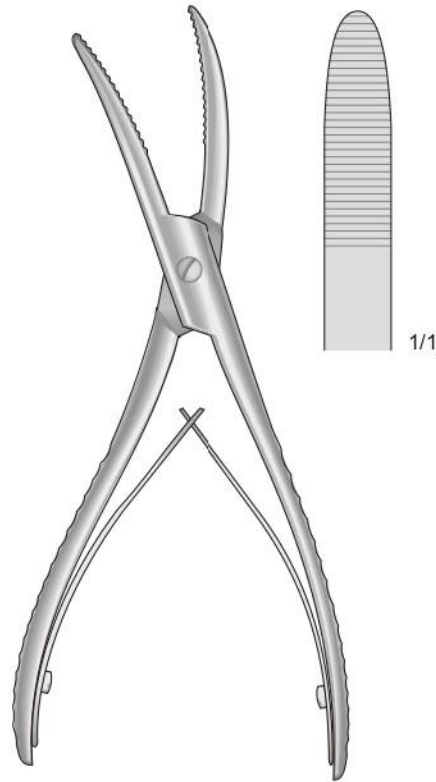

WOLFF  
SSQ-6873  
180 mm

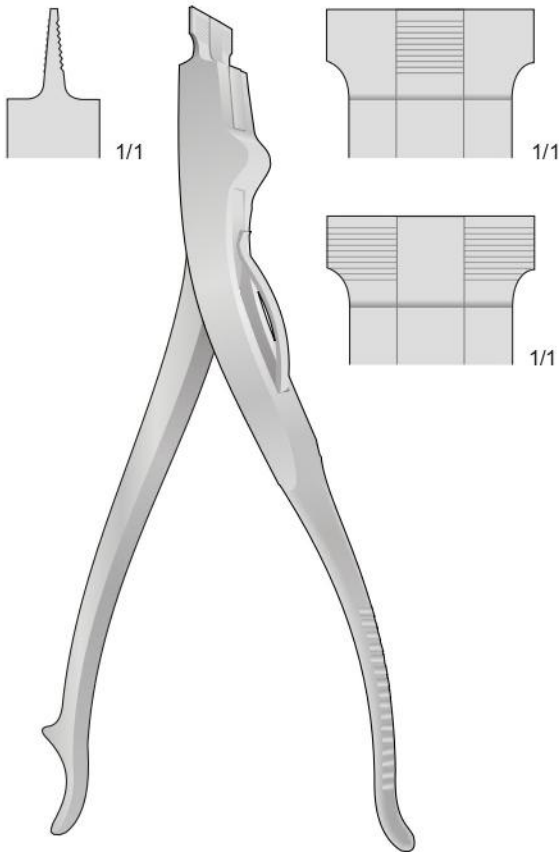

LAWTON  
SSQ-6874  
220 mm

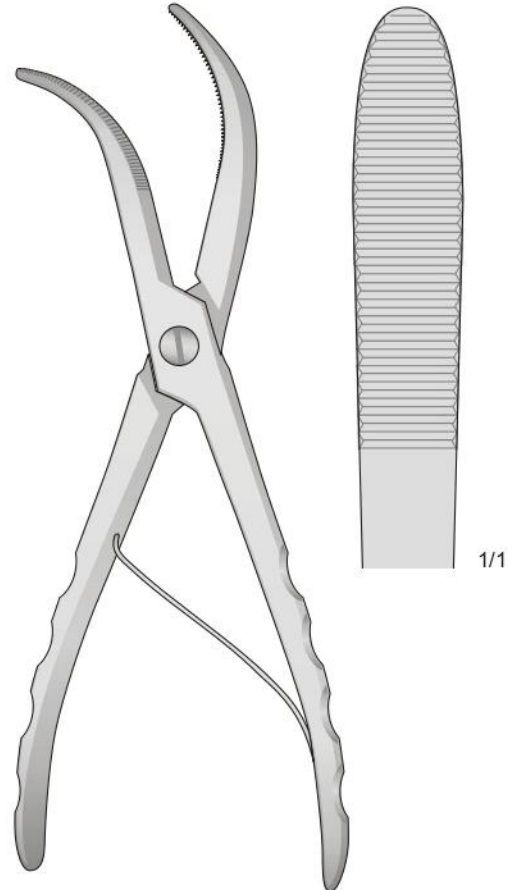

WOLFF  
SSQ-6875  
250 mm

Cesoie per gesso  
Gips - Schneidezangen

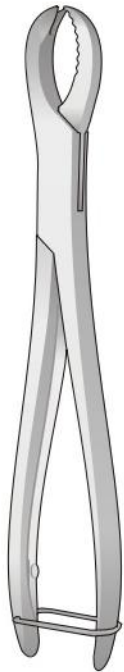

1/1

SSQ-6876  
210 mm

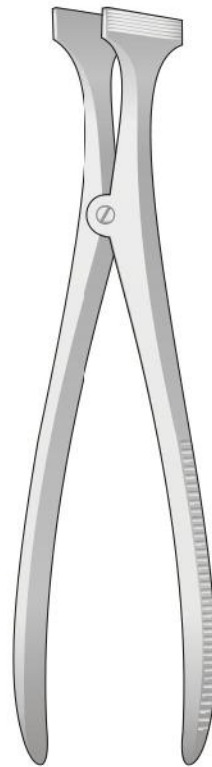

HENNIG  
SSQ-6877  
270 mm

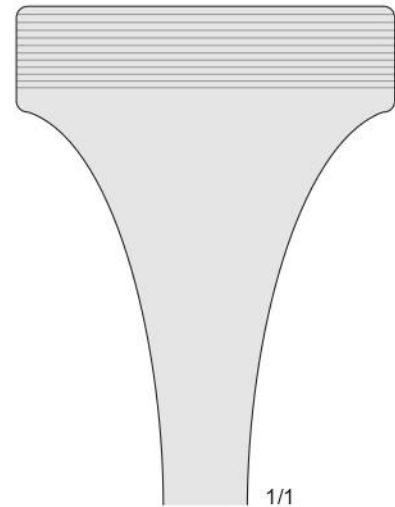

1/1

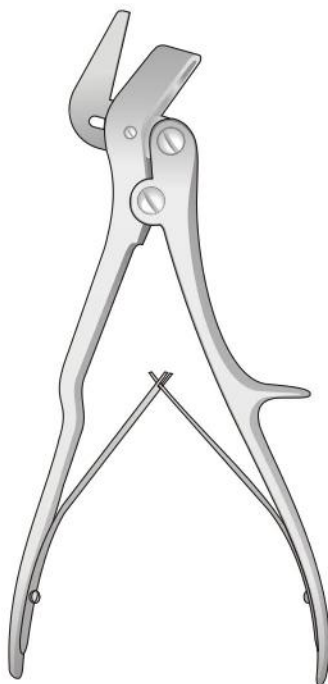

STILLE  
SSQ-6878  
230 mm

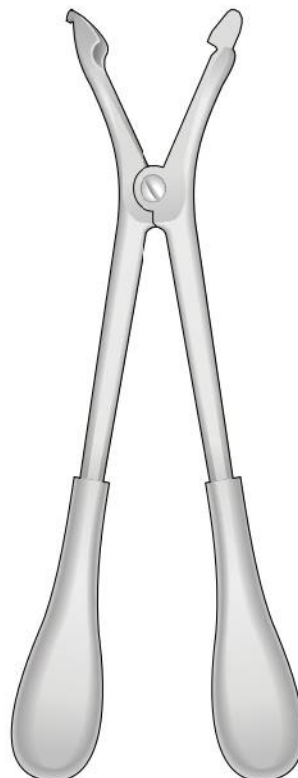

HAGLUND  
SSQ-6879  
280 mm

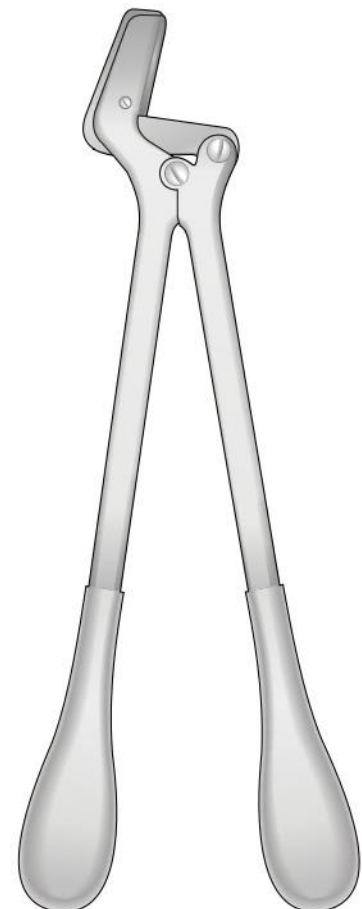

STILLE  
SSQ-6880  
370 mm



*Manufacturer & Exporter Of Surgical Instruments.*

- ☎ +92-52-3532361
- ☎ +92 (302) 775 4954 | +92 (301) 618 3770
- ✉ [ssqintl1@gmail.com](mailto:ssqintl1@gmail.com) | [info@ssqintl.com](mailto:info@ssqintl.com)
- 📍 Kotli Loharan West, Near Chella, Sialkot - Pakistan



[www.ssqintl.com](http://www.ssqintl.com)