

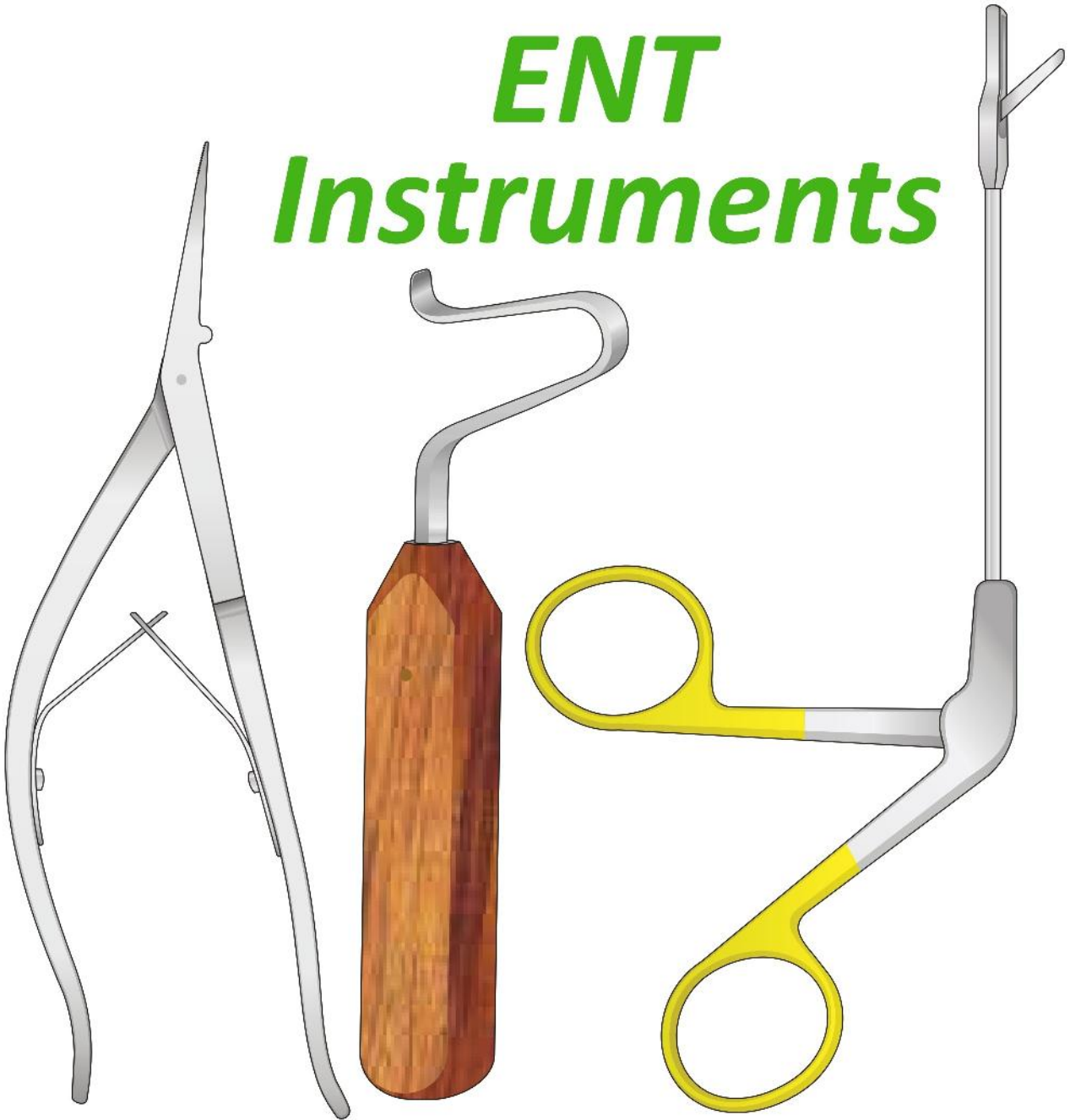

INTERNATIONAL

LET'S SHARE ABOUT SURGERY

ENT Instruments



www.ssqintl.com

**Surgical
Instruments
Catalogue**

Per adulti - For adults
Für Erwachsene - Pour adultes
Para adultos

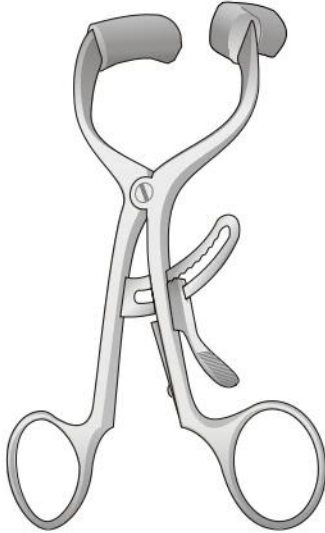

DOYEN-JANSEN
SSQ-8001
140 mm

Per adulti - For adults
Für Erwachsene - Pour adultes
Para adultos

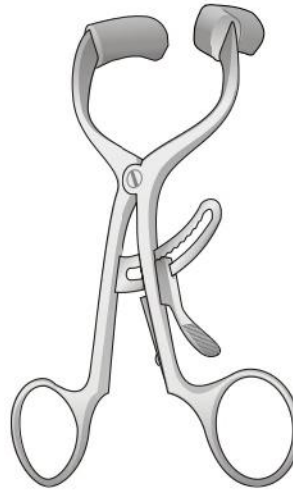

DOYEN-COLLIN
SSQ-8002
120 mm

Per bambini
For children
Für Kinder
Pour enfants
Para niños

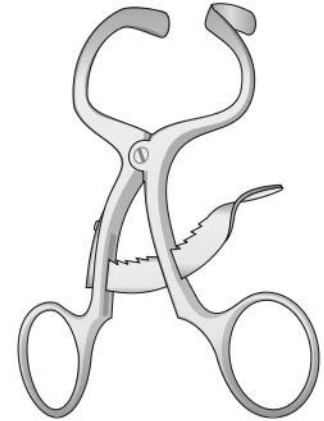

MOLT
SSQ-8003
100 mm

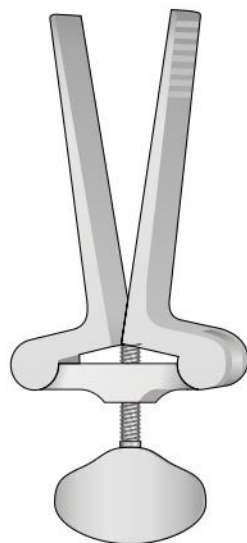

HEISTER
SSQ-8004
135 mm

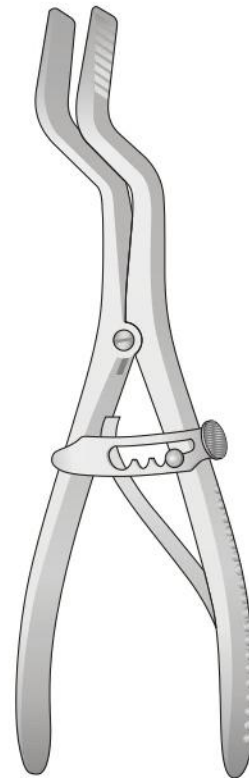

ROSER KÖNIG
SSQ-8005
185 mm

Apribocca con aspirazione
Mouth gag with suction
Mundsperrer mit Absauger

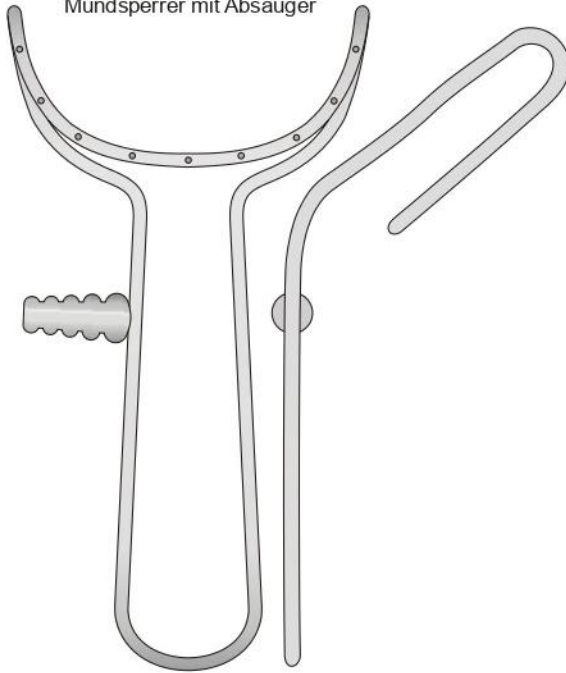

SSQ-8006
140 mm

Apribocca senza aspirazione
Mouth gag without suction
Mundsperrer ohne Absauger

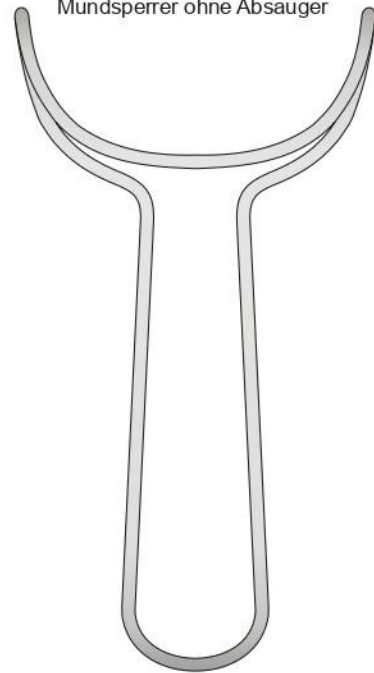

SSQ-8007
150 mm

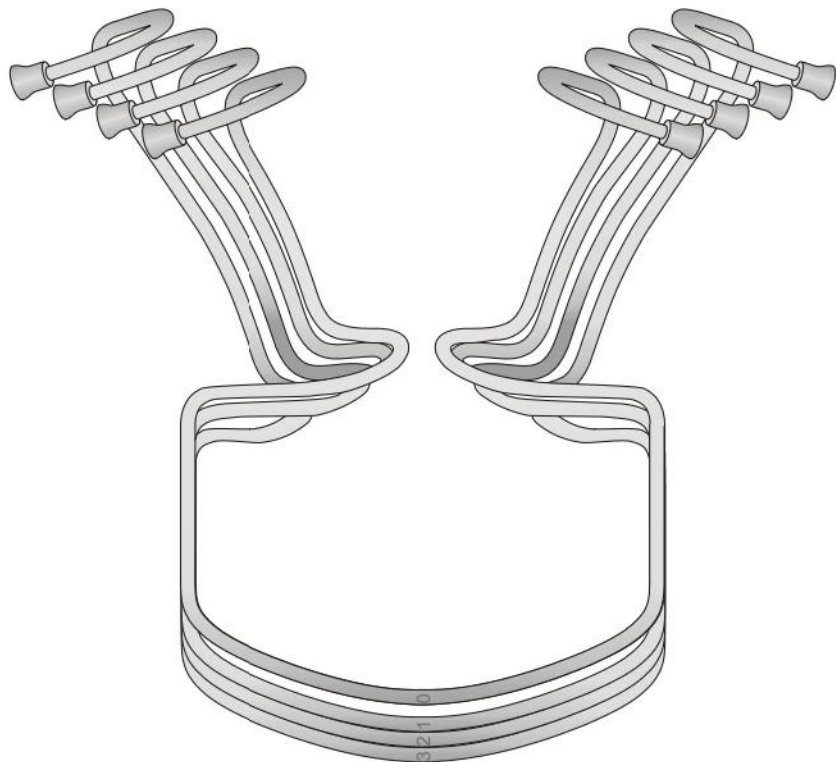
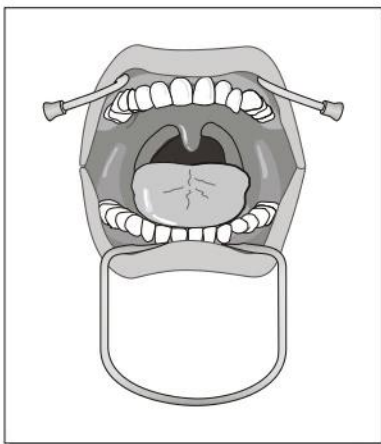

ORINGER

SSQ-8008	Fig. 0	100 x 95 mm	Per bambini
SSQ-8009	Fig. 1	115 x 105 mm	Per adulti
SSQ-8010	Fig. 2	115 x 110 mm	Per adulti
SSQ-8011	Fig. 3	125 x 115 mm	Per adulti

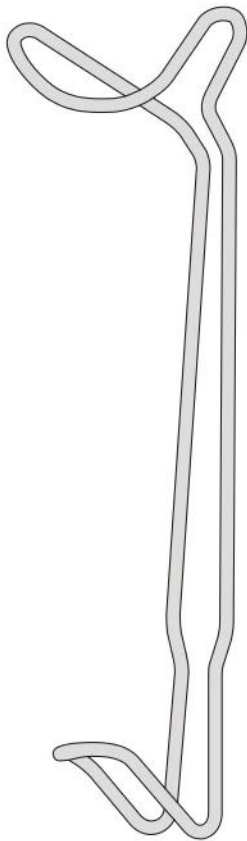

SSQ-8012
210 mm

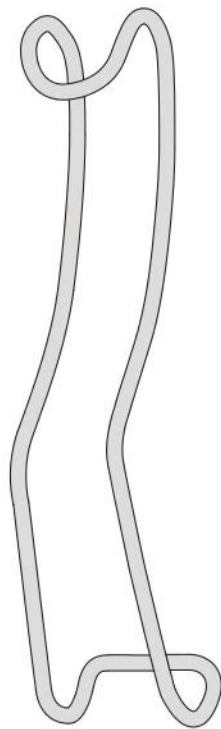

STERNBERG
SSQ-8013
160 mm

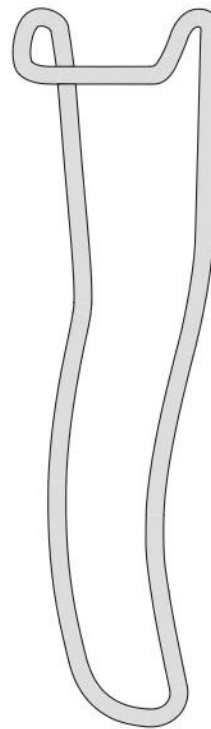

STERNBERG
SSQ-8014
160 mm



MINNESOTA
SSQ-8015
140 mm

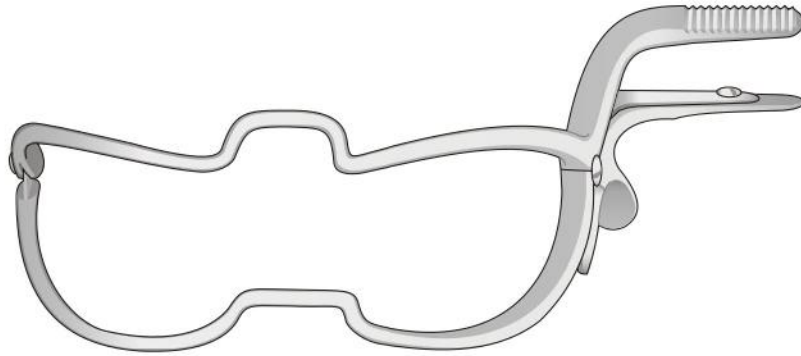

WHITEHEAD-JENNINGS
 SSQ-8016 90 mm
 SSQ-8017 110 mm
 SSQ-8018 130 mm
 SSQ-8019 150 mm

Apribocca solo
 Gag only
 Sperrer allein
 Manche et cadreseuls
 Apre-boca suelto

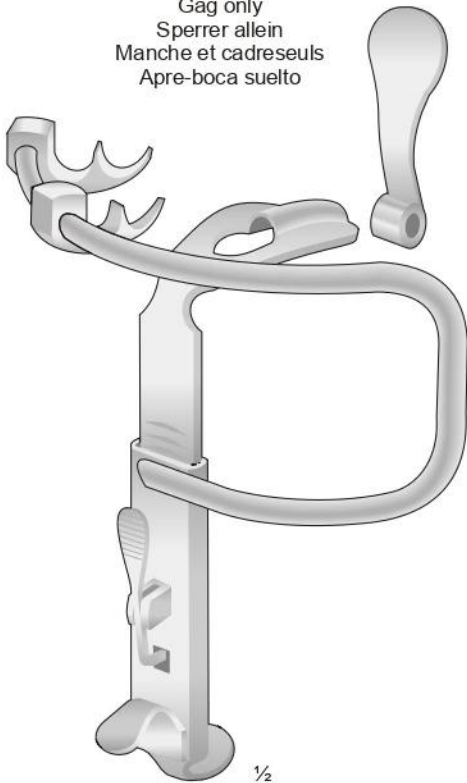

KILNER-DOUGHTY
 SSQ-8023

Fig. 1



SSQ-8020
 8 x 65 mm

Fig. 2

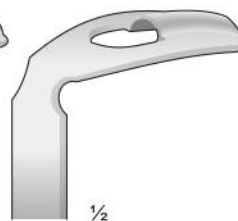

SSQ-8021
 32 x 75 mm

Fig. 3

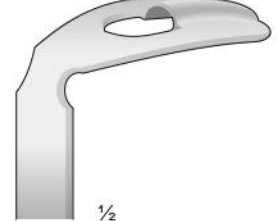

SSQ-8022
 37 x 80 mm

KILNER-DOUGHTY
 13-220

Completo con 3 abbassalingua
 Complete with 3 tongue depressors
 Komplet mit 3 Zungenspatel
 Complet avec 3 abaisse-langues
 Completo con 3 abaja lengua

Apribocca solo
Gag only
Sperrer allein
Manche et cadreseuls
Apre-boca suuelto

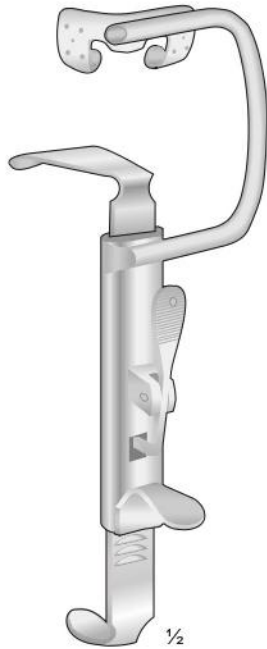

DAVIS-BOYLE
SSQ-8023-1

DAVIS-BOYLE
13-240
Completo con 5 abbassalingua
Complete with 5 tongue depressors
Komplet mit 5 Zungenspatel
Complet avec 5 abaisse-langues
Completo con 5 abaja lengua

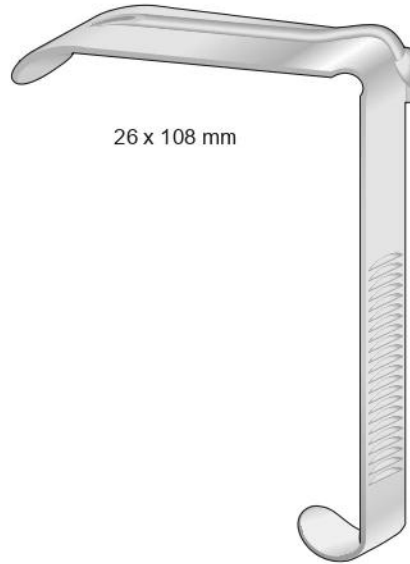

SSQ-8023-2



13-230-02
25 x 93 mm



SSQ-8023-3
24 x 80 mm



SSQ-8023-4
23 x 65 mm



SSQ-8023-5
21 x 30 mm

Mc-IVOR
13-260
Completo di 3 abbassalingua
Complete with 3 tongue depressors
Komplet mit 3 Zungenspatel
Complet avec 3 abaisse-langues
Completo con 3 abaja lengua

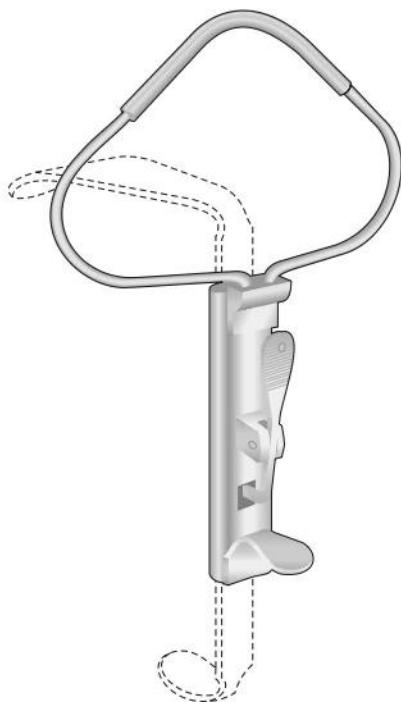

Mc-IVOR
SSQ-8024-1



SSQ-8024-2

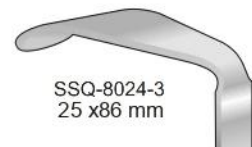

SSQ-8024-3
25 x 86 mm

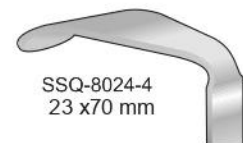

SSQ-8024-4
23 x 70 mm

Telaio Dingmann con
due apriguancia

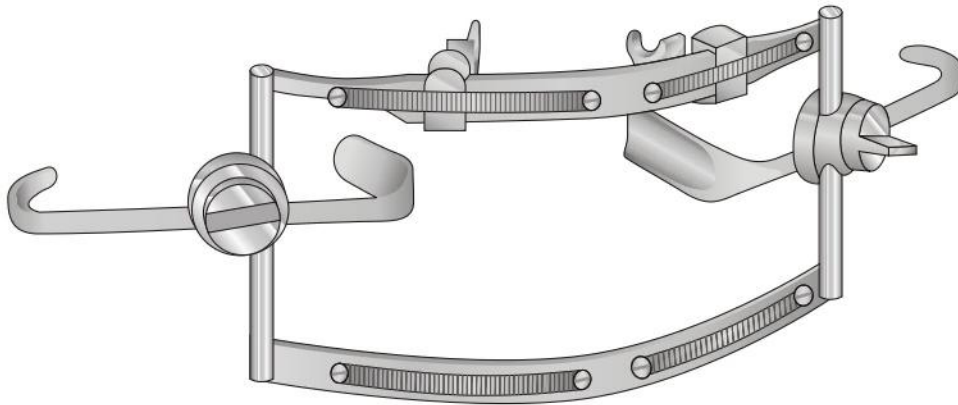

SSQ-8025-1

Abbassalingua
Tongue depressor
Zungenspatel
Abaisse langues
Bejalenguas

Fig. 1

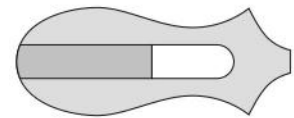

SSQ-8025-2
piccolo

Fig. 2

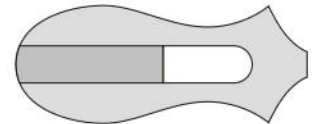

SSQ-8025-3
medio

Fig. 3

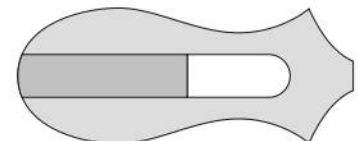

SSQ-8025-4
grande

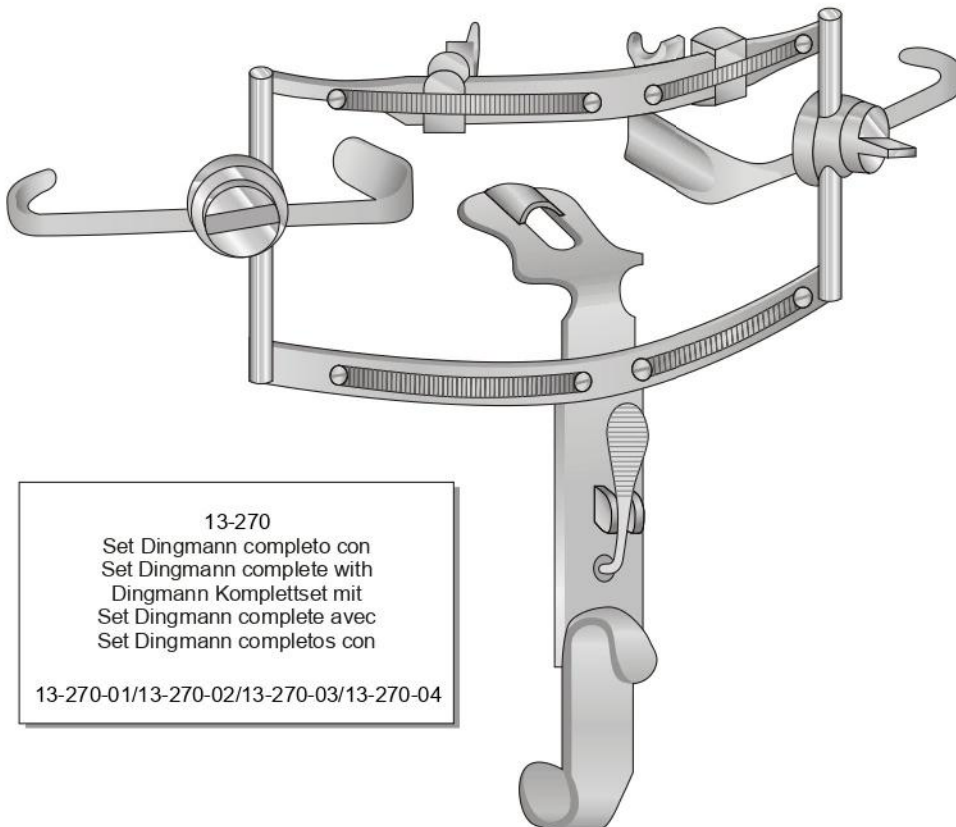

13-270
Set Dingmann completo con
Set Dingmann complete with
Dingmann Kompletset mit
Set Dingmann complete avec
Set Dingmann completos con

13-270-01/13-270-02/13-270-03/13-270-04

DINGMANN
SSQ-8025
Set completo



SSQ-8026-1
110 mm



SSQ-8026-2
160 mm



SSQ-8027
195 mm

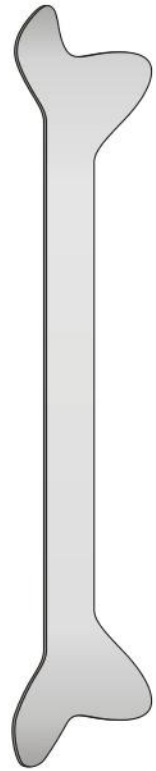

SSQ-8028
180 mm

Spatole inox malleabili
Spatulas malleable



SSQ-8028-1
200 mm



SSQ-8028-2
200 mm



SSQ-8028-3
240 mm

Spatole Inox malleabili antiriflesso nere
Spatulas malleable black anodized

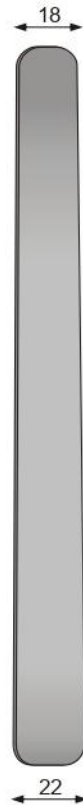

SSQ-8028-4
200 mm



SSQ-8028-5
200 mm

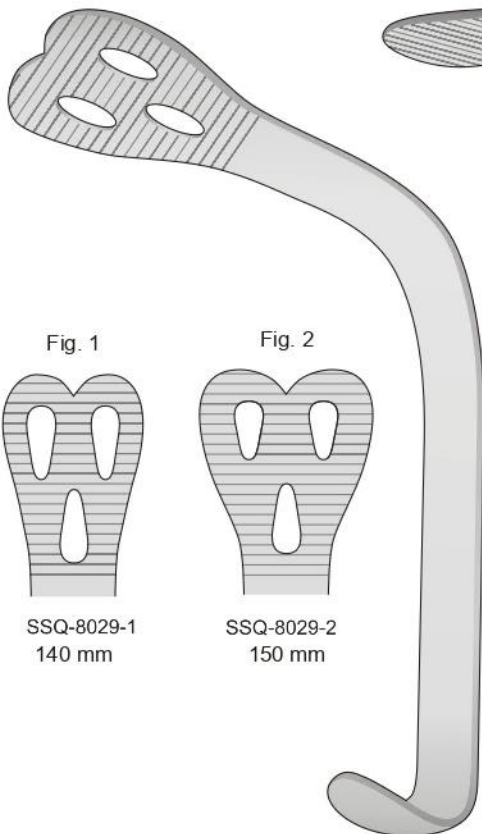
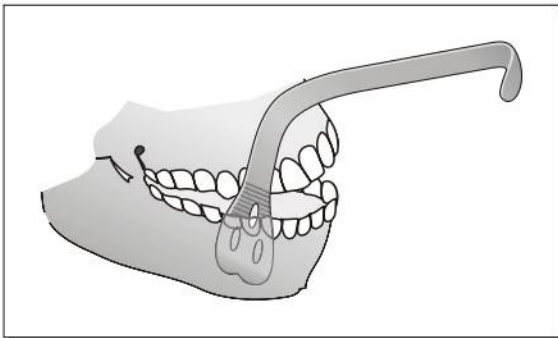

Fig. 1

Fig. 2

SSQ-8029-1
140 mm

SSQ-8029-2
150 mm

WIEDER
SSQ-8029

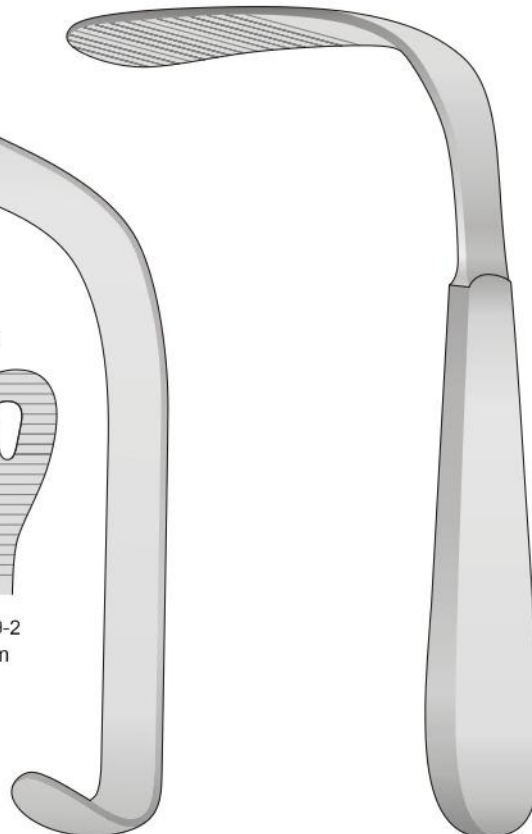

TOBOLD
SSQ-8030
145 mm

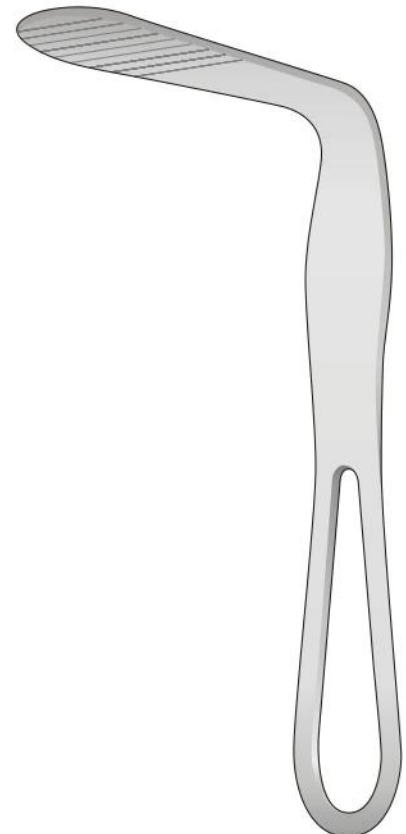

HARTMANN
SSQ-8031
150 mm

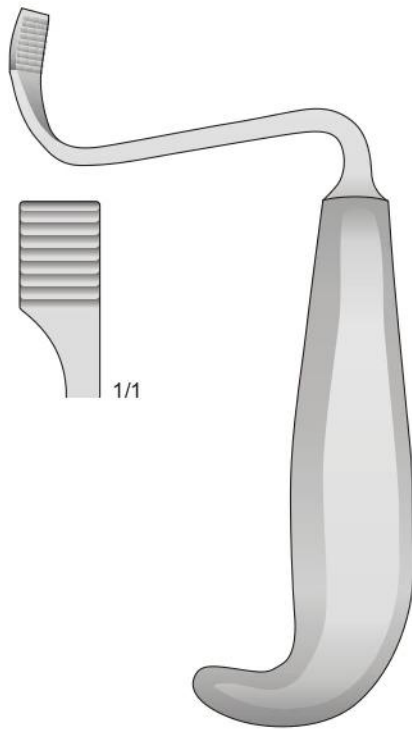

TESSIER
SSQ-8032-1
150 mm

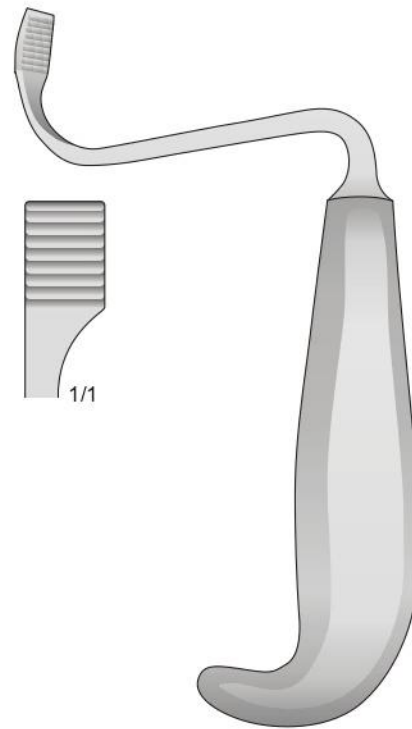

TESSIER
SSQ-8032-2
150 mm

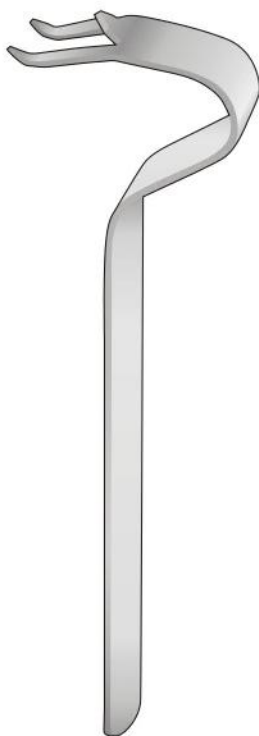

OBWEGESER
SSQ-8033
155 mm

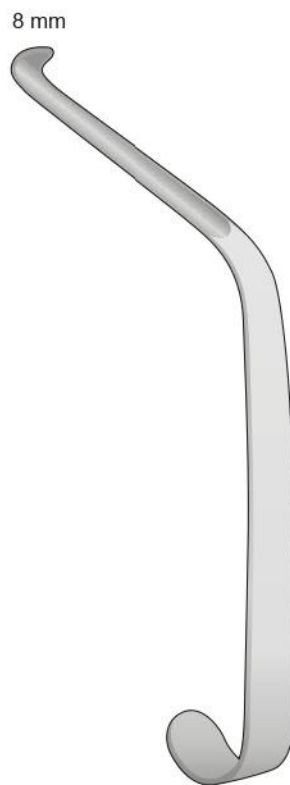

OBWEGESER
SSQ-8034-1
165 mm

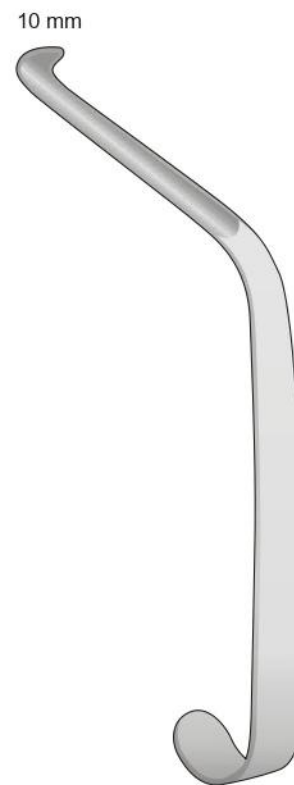

OBWEGESER
SSQ-8034-2
165 mm

6 x 13 mm



DUNN-DAUTREY
SSQ-8035-1
130 mm

8 x 18 mm



DUNN-DAUTREY
SSQ-8035-2
125 mm

Posteriore

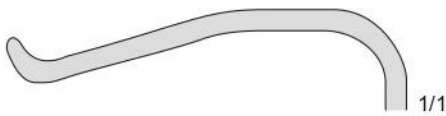

1/1

Anteriore

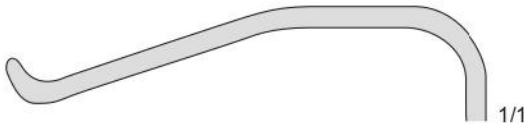

1/1

Superiore

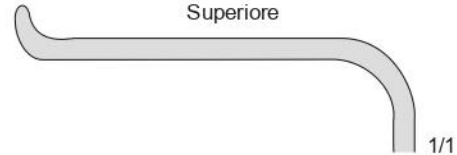

1/1

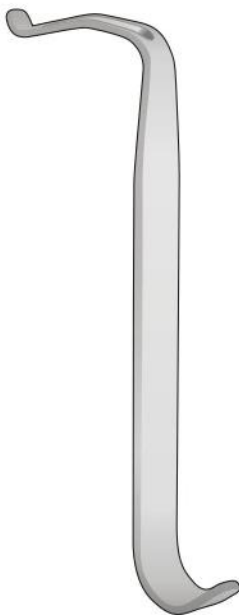

DUNN-DAUTREY
SSQ-8036-1 6,5 x 50 mm
140 mm

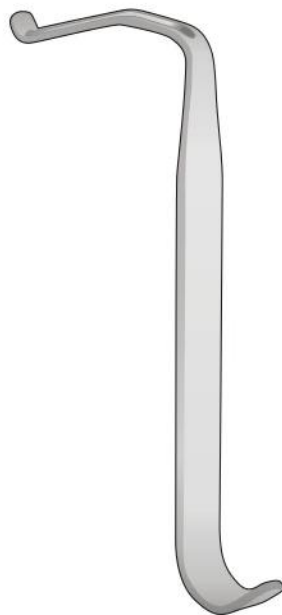

DUNN-DAUTREY
SSQ-8036-2 6,5 x 60 mm
140 mm

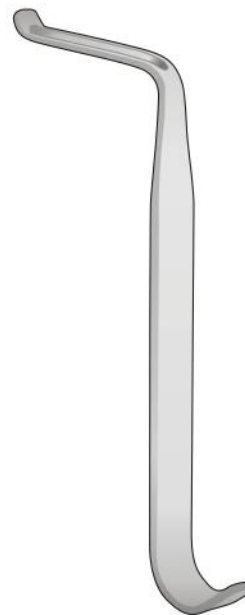

DUNN-DAUTREY
SSQ-8036-3 8 x 50 mm
140 mm

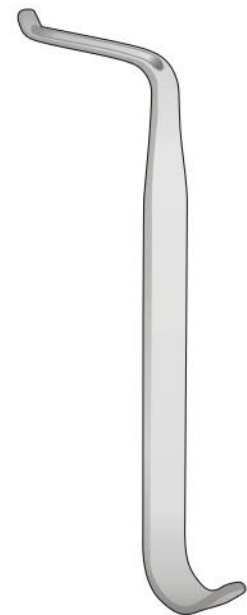

DUNN-DAUTREY
SSQ-8036-4 5 x 50 mm
140 mm

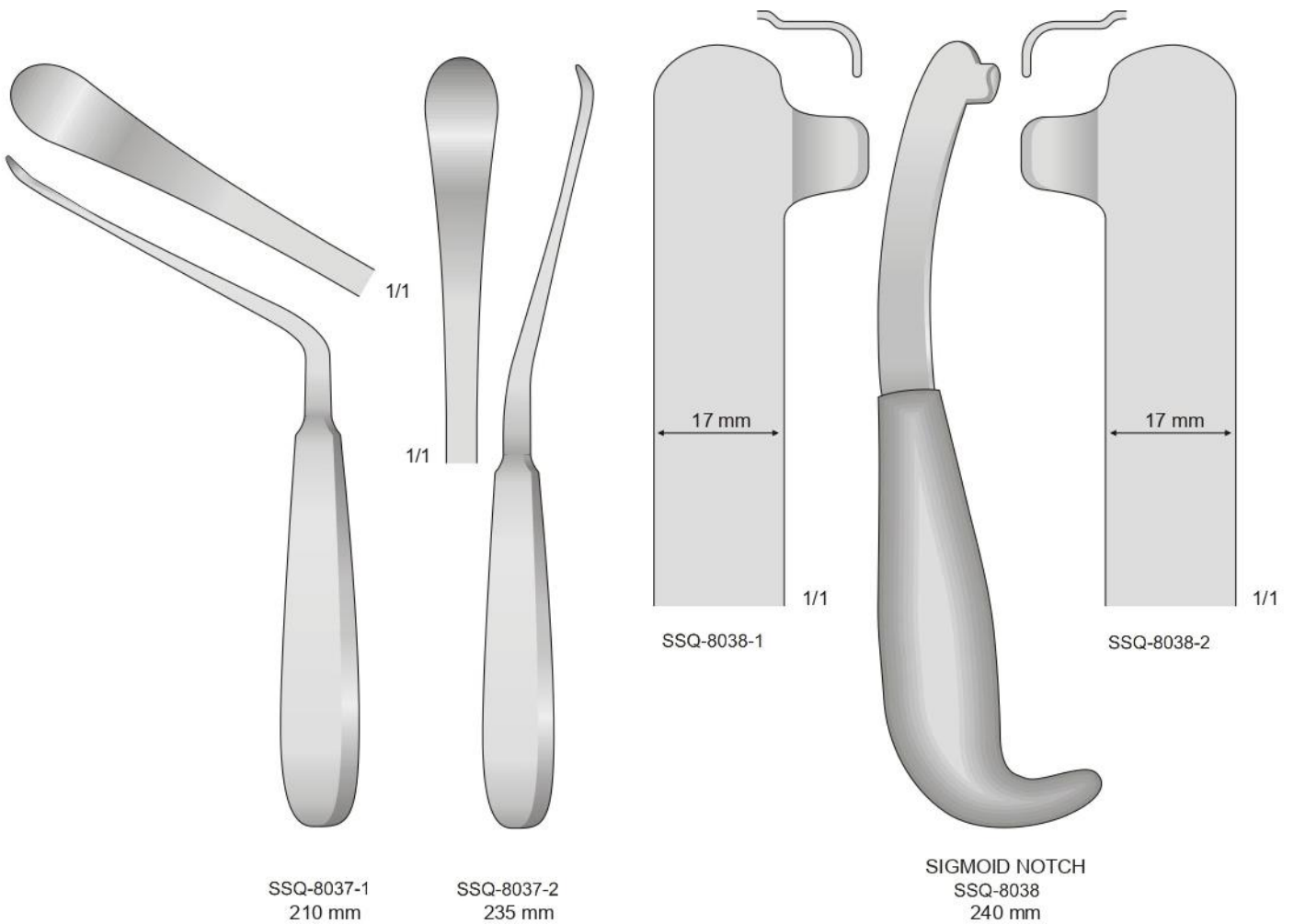

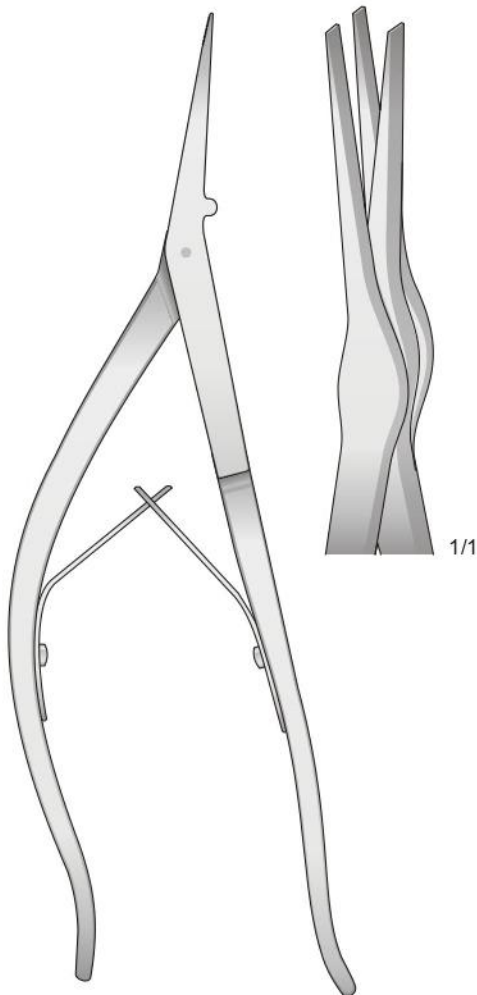
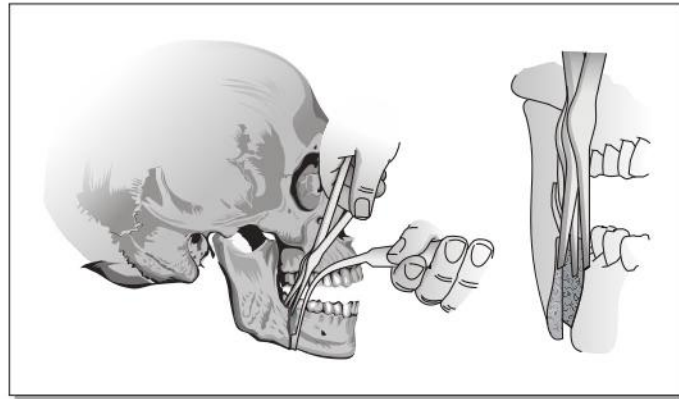

RAMUS
SSQ-8039
230 mm

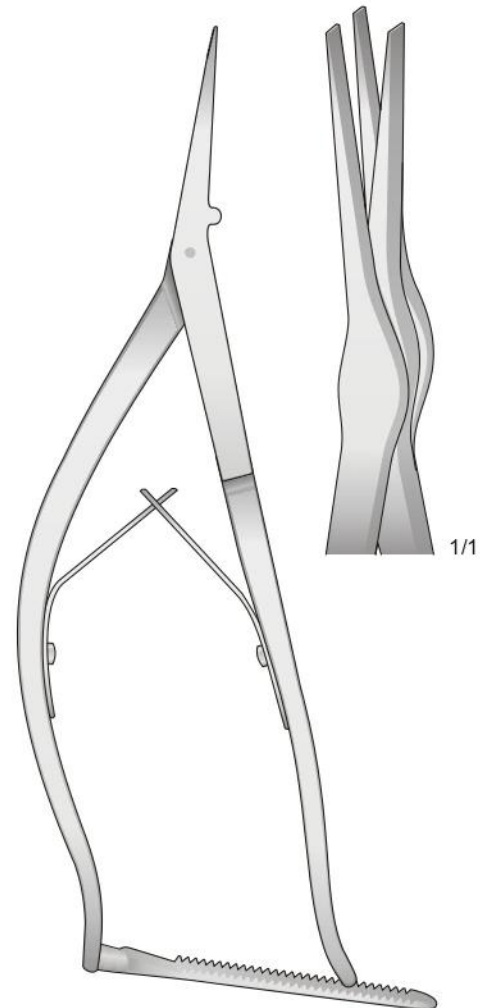

RAMUS
SSQ-8040
230 mm

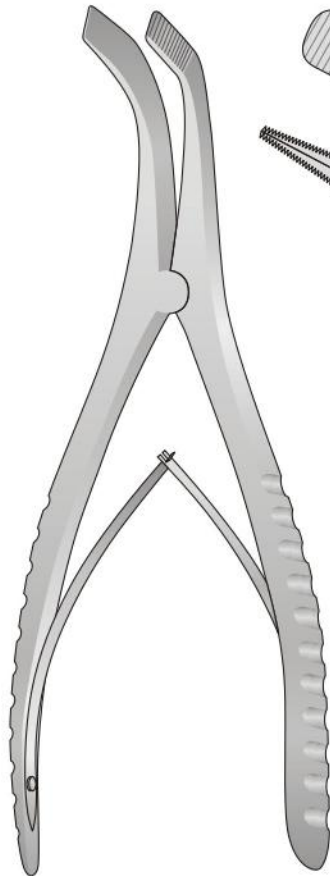
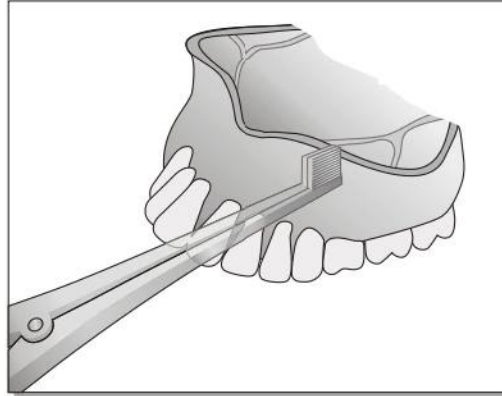

TESSIER
SSQ-8041
180 mm

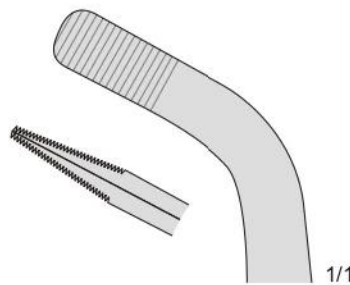

Maxillary expander

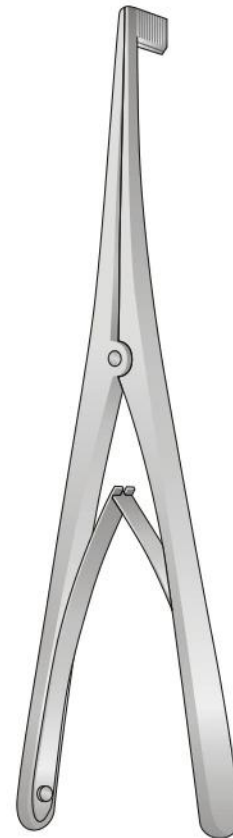

SSQ-8042
170 mm

Lattanti
For juveniles
Für Jugendliche

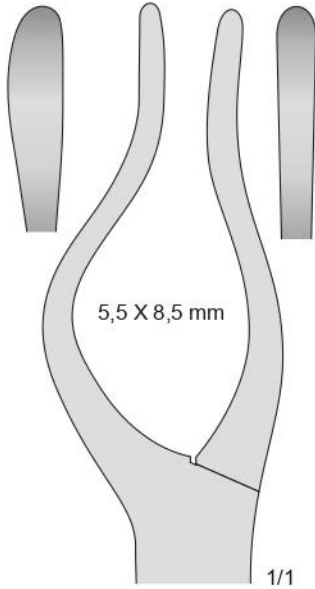

SSQ-8043-1
SSQ-8043-2
225 mm

Per bambini
For children
Für Kinder
Pour enfants
Para niños

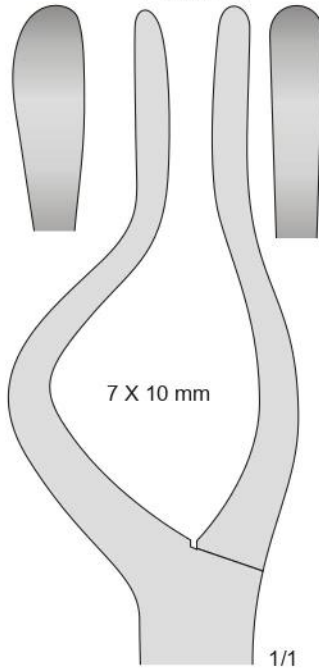

SSQ-8044-1
SSQ-8044-2
235 mm

Per adulti
For adults
Für Erwachsene
Pour adultes
Para adultos

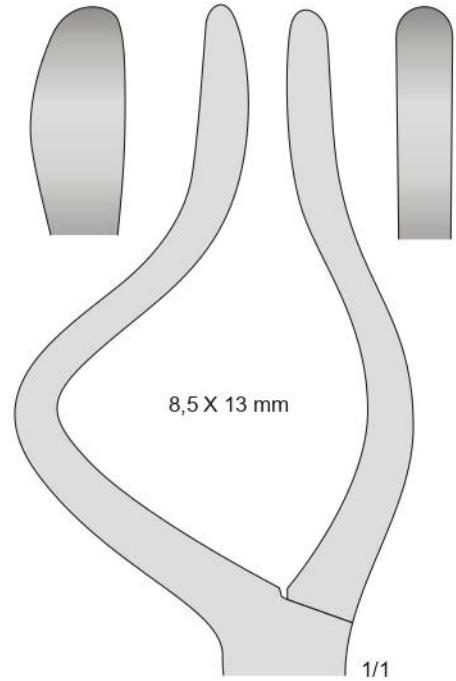

SSQ-8045-1
SSQ-8045-2
240 mm

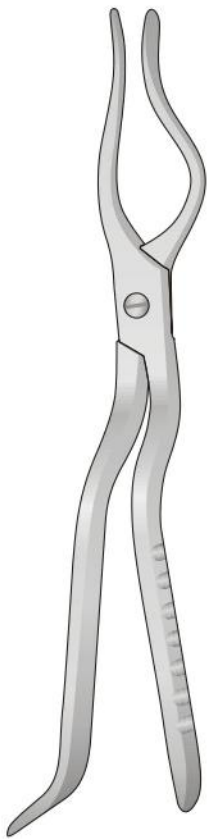

ROWE

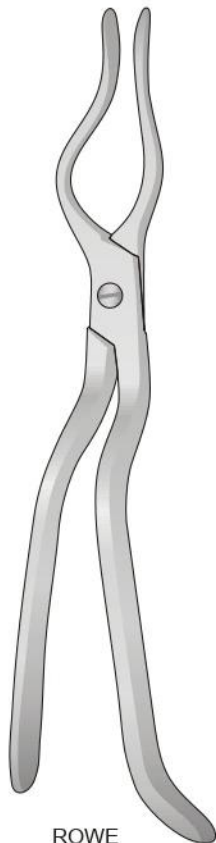

ROWE

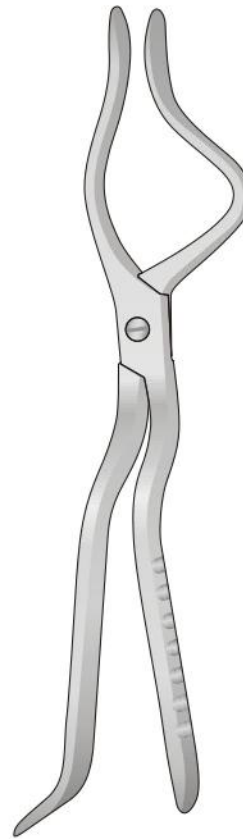

ROWE

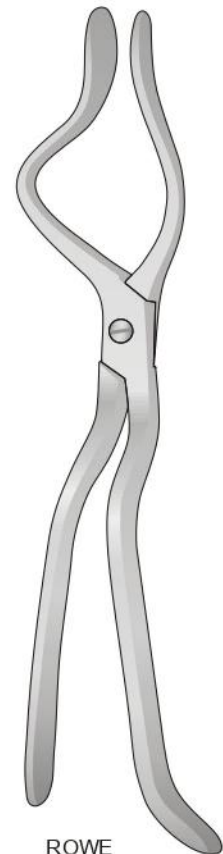

ROWE

Uncini

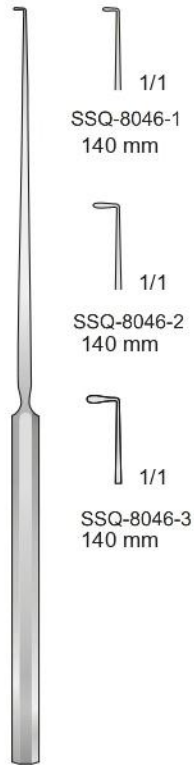

LUCAE
SSQ-8046
140 mm

Curette - Curettes - Löffel - Curettes - Curetas

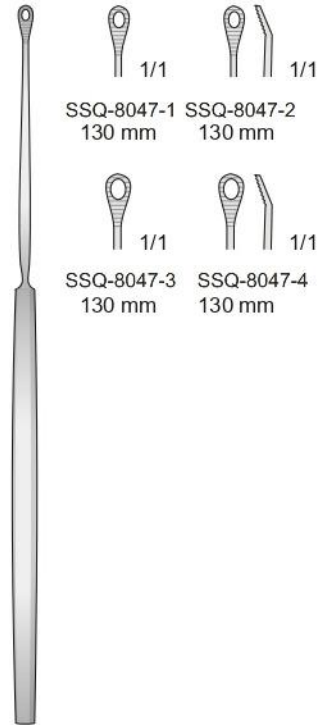

SHAPLEIGH
SSQ-8047
130 mm

Uncini

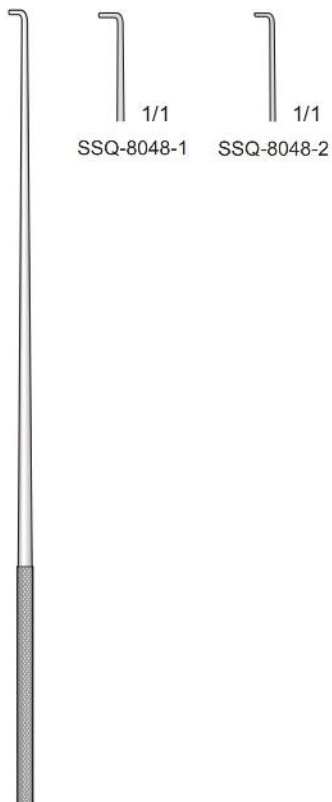

DAY
SSQ-8048
160 mm

Anse auricolari - Ear loops anses - Ohrschlingen - Ansas auricolares

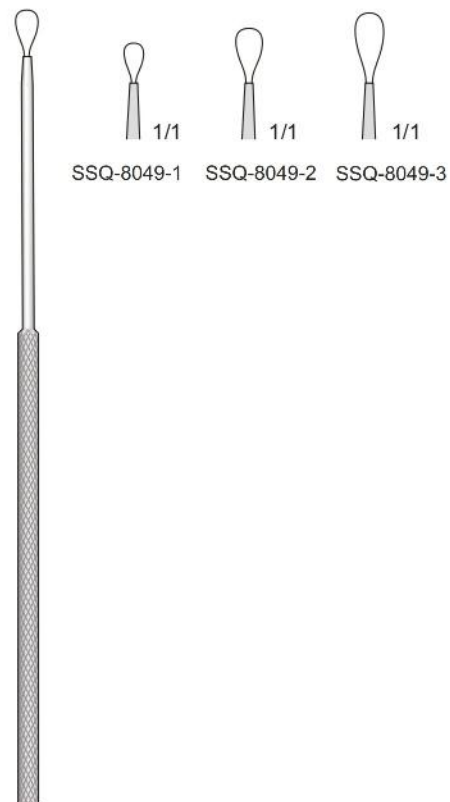

BILLEAU
SSQ-8049
160 mm

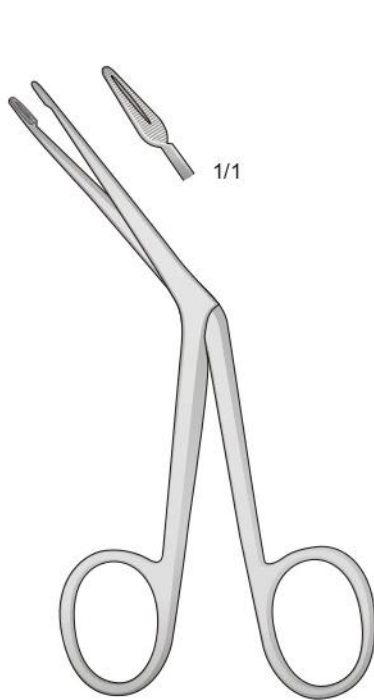
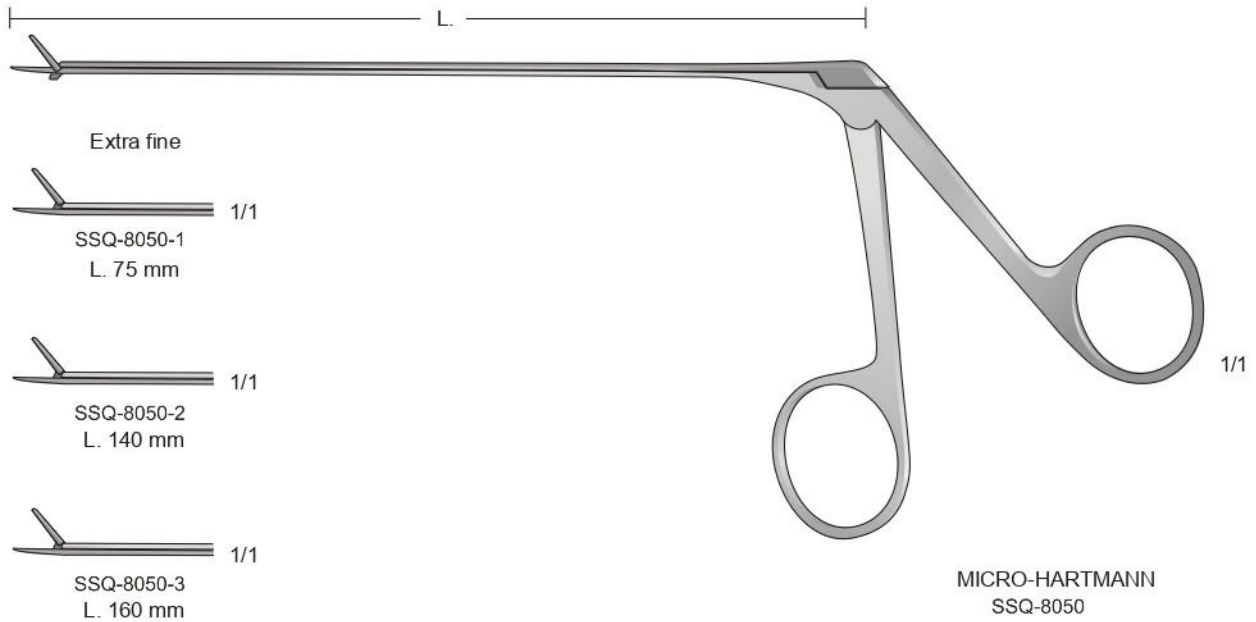

LITTAUER
SSQ-8051
120 mm

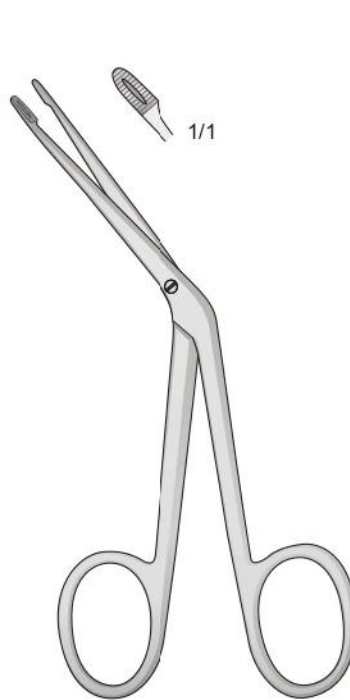

HARTMANN
SSQ-8052-1
120 mm

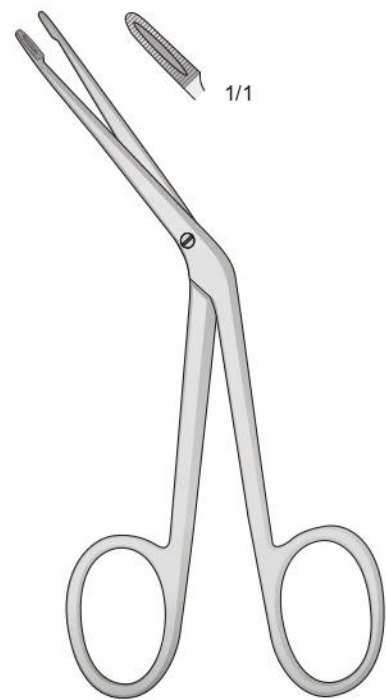

HARTMANN
SSQ-8052-2
140 mm

Pinze auricolari
Ear Forceps
Ohr-Polypenzangen
Pincès pour polypes auriculaires
Pinzas auricolàres



SSQ-8053-1
L.85 mm



SSQ-8053-2
L.85 mm



SSQ-8053-3
L.85 mm



SSQ-8053-4
L.85 mm



SSQ-8053-5
L.85 mm



SSQ-8053-6
L.140 mm
13-550-07
L.165 mm

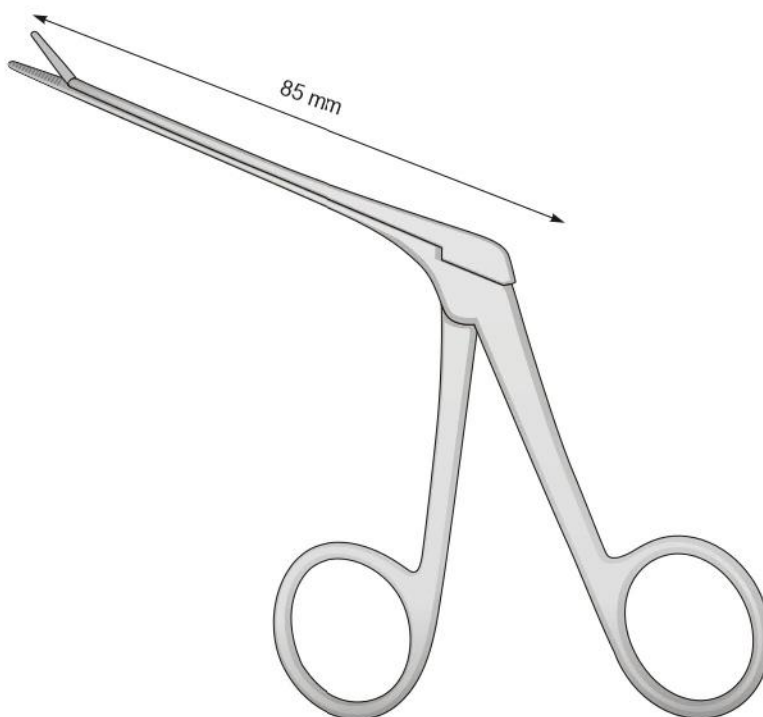

SSQ-8053
L. 85 mm

Micro forbice
Micro scissor
Mikro Scheren
Micro ciseaux
Micro tijeras

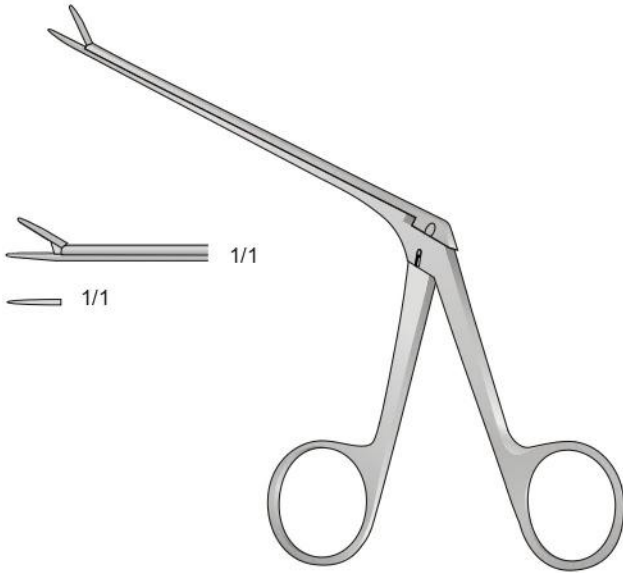

SSQ-8054
80 mm

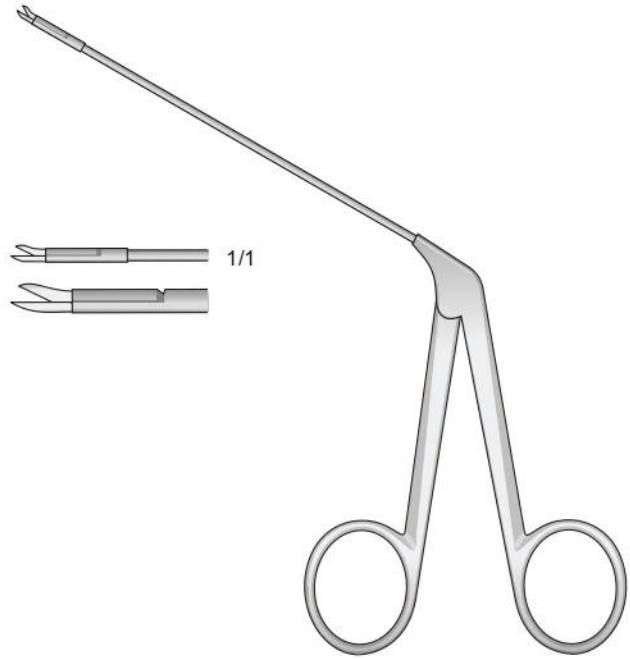

BELLUCCI
SSQ-8055
80 mm

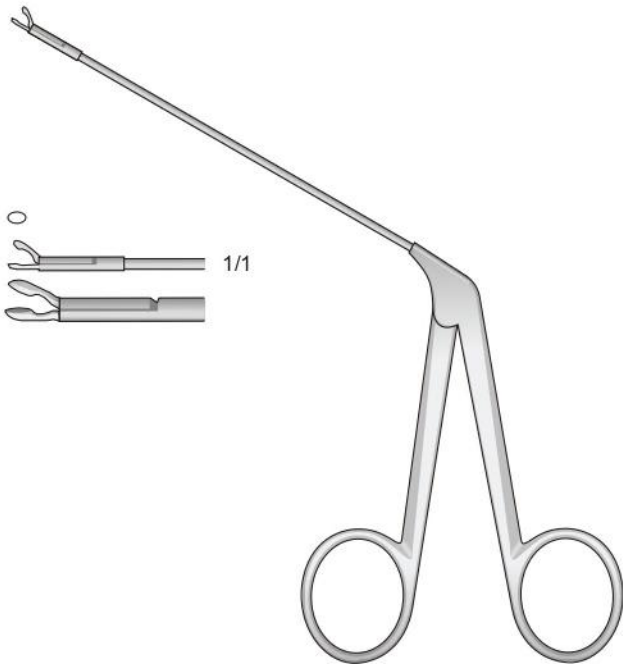

WULLSTEIN
SSQ-8056
80 mm

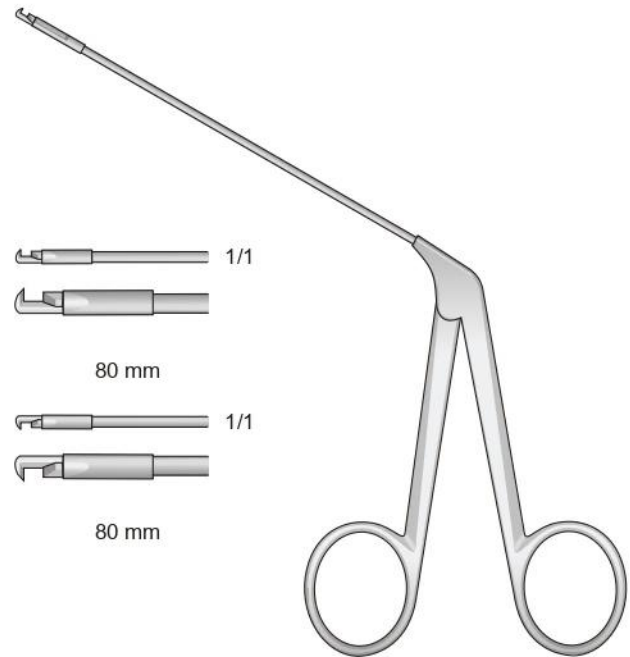

DIETER
SSQ-8057
80 mm

Mikro-Schere



FAHLBUSCH
SSQ-8058-1
165 mm

FAHLBUSCH
SSQ-8058-2
230 mm

Scharfe Zange

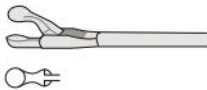

NICOLA
SSQ-8058-3
165 mm

NICOLA
SSQ-8058-4
230 mm

Mikro-Schere

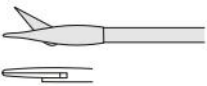

NICOLA
SSQ-8058-5
165 mm

NICOLA
SSQ-8058-6
230 mm

Faßzange

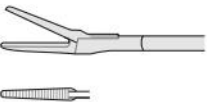

YASARGIL-NICOLA
SSQ-8058-7
165 mm

YASARGIL-NICOLA
SSQ-8058-8
230 mm

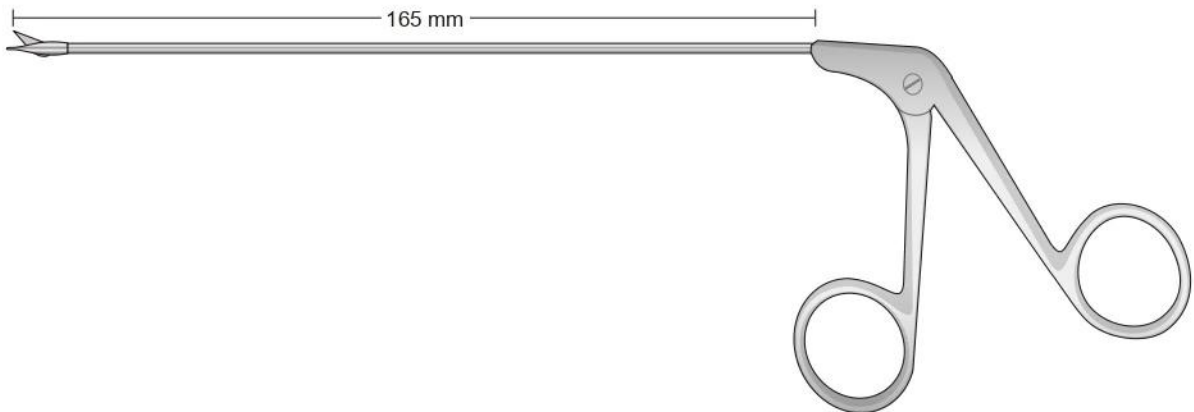

NICOLA
SSQ-8058
165 mm

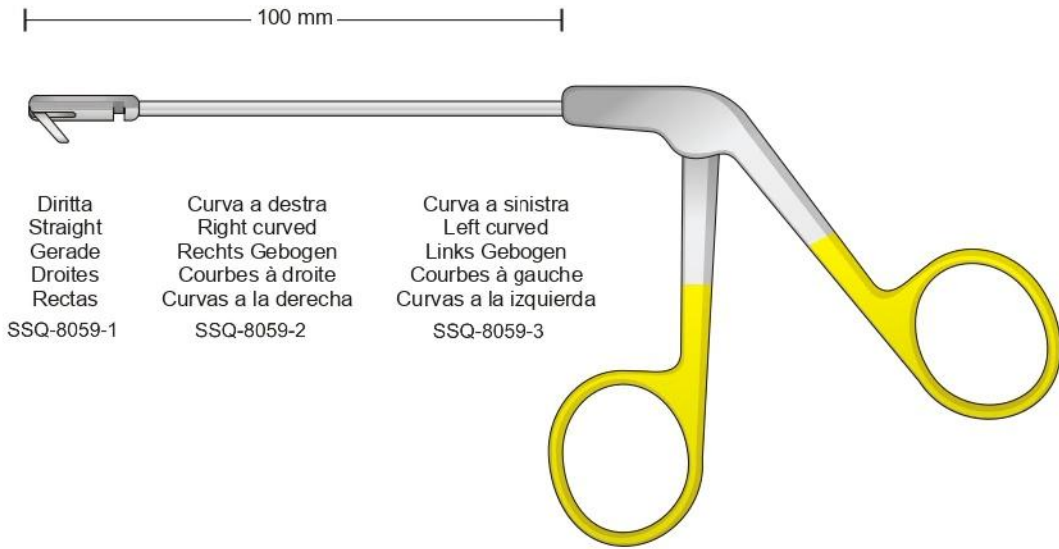

STAMBERGER
SSQ-8059

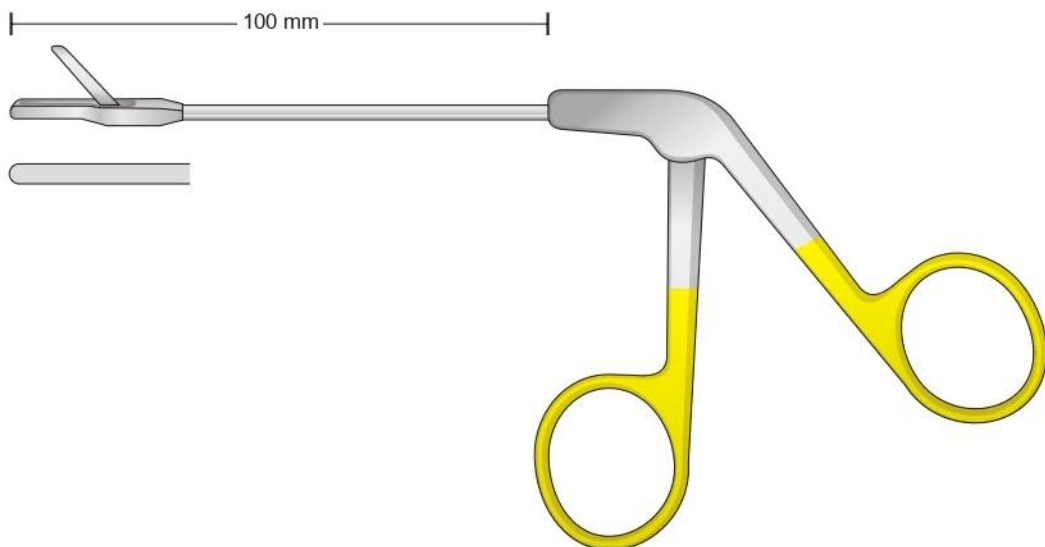

STRUYCKEN
SSQ-8060

130 mm

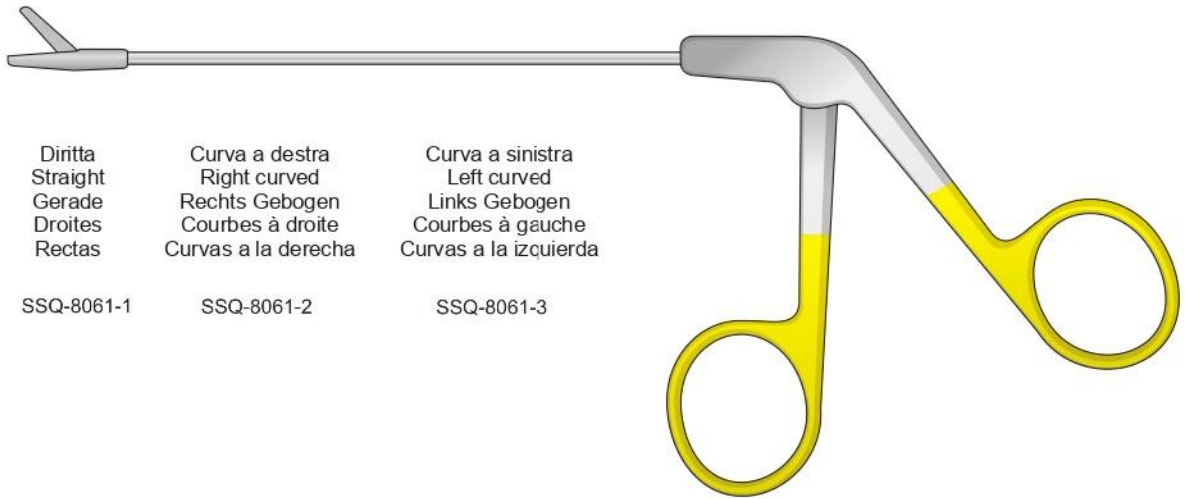

Diritta Straight Gerade Droites Rectas	Curva a destra Right curved Rechts Gebogen Courbes à droite Curvas a la derecha	Curva a sinistra Left curved Links Gebogen Courbes à gauche Curvas a la izquierda
SSQ-8061-1	SSQ-8061-2	SSQ-8061-3

SSQ-8061

140 mm

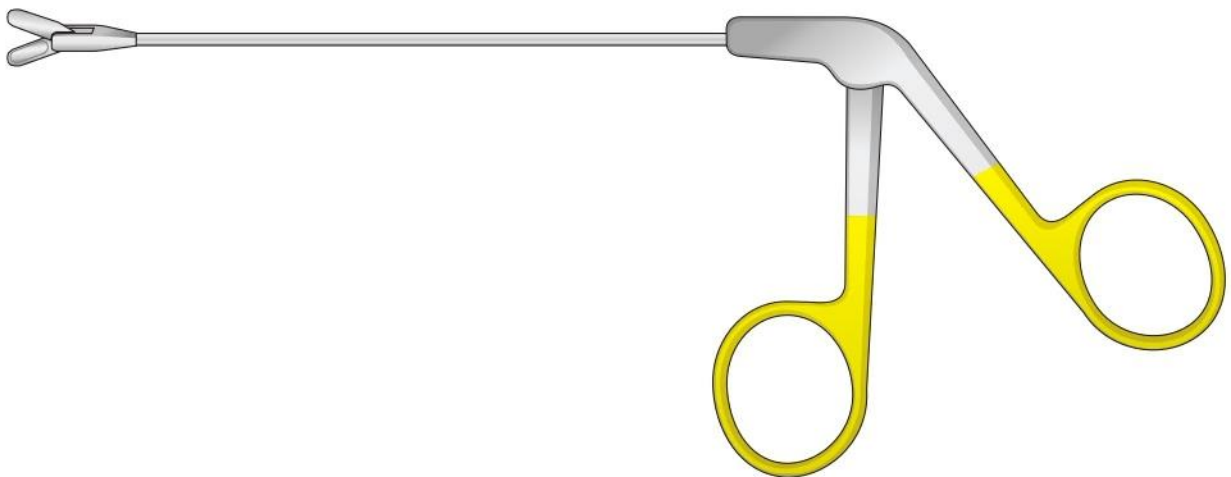

SSQ-8062

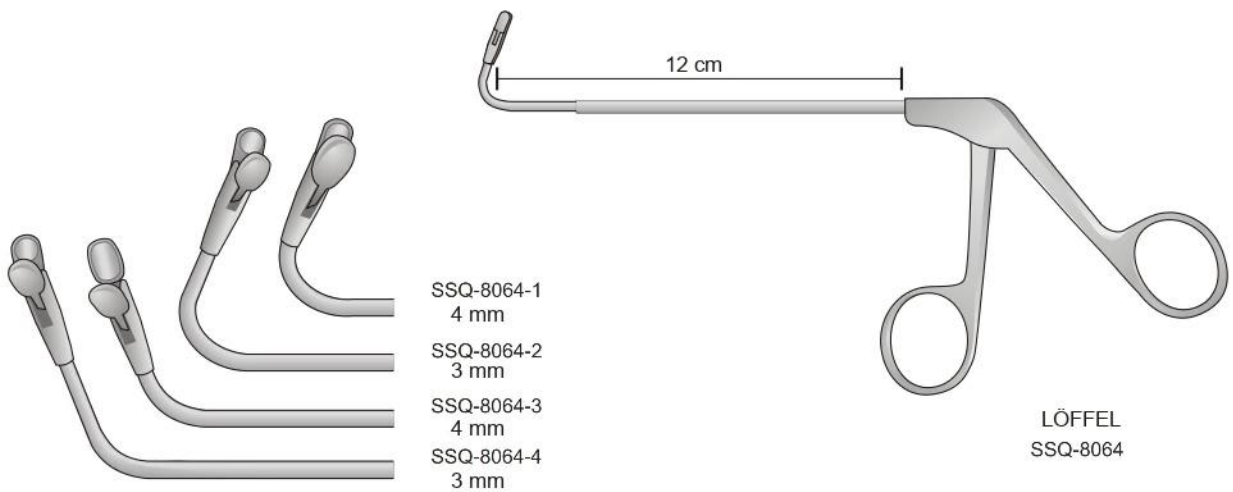
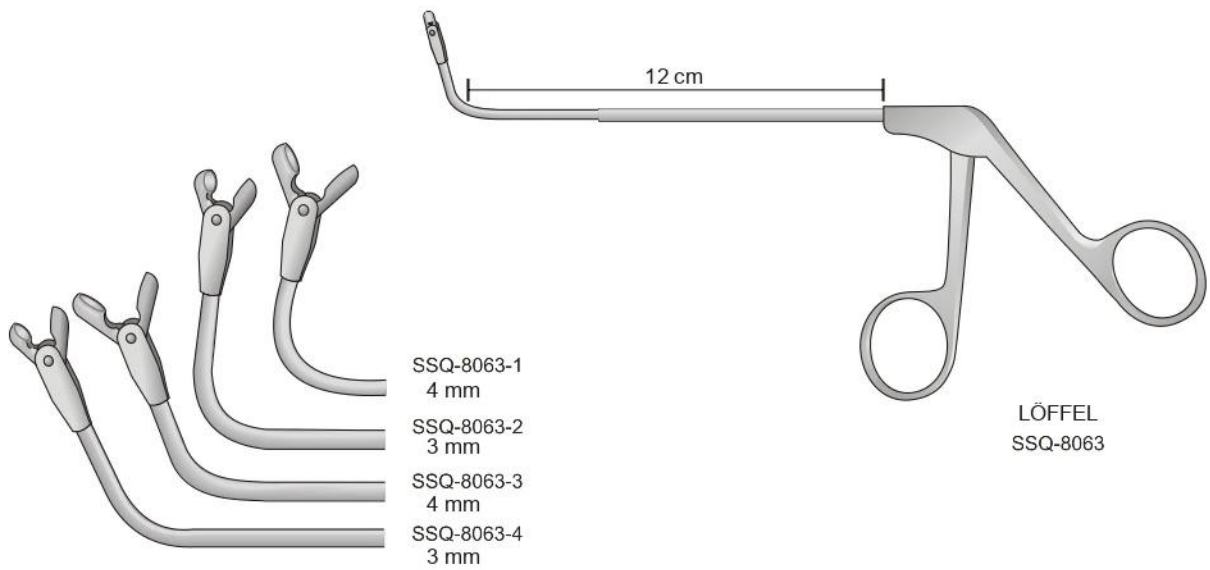

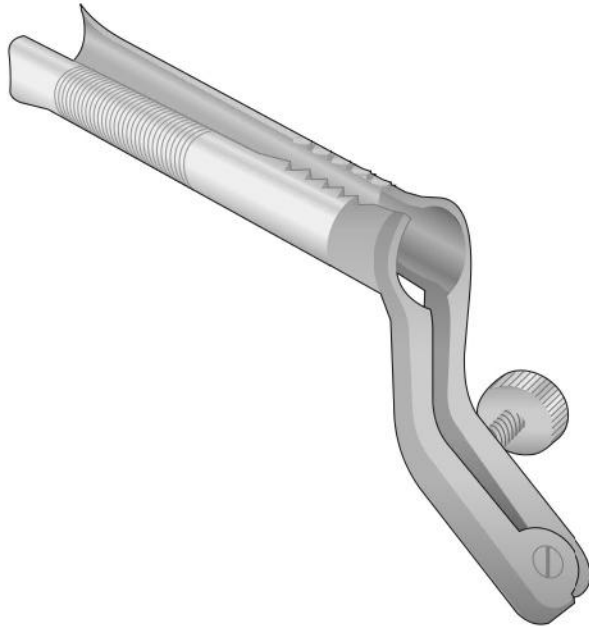

PAPAVERO-CASPAR
SSQ-8065-1 80 x 11 mm
SSQ-8065-2 90 x 13 mm
SSQ-8065-3 100 x 15 mm



PAPAVERO-HARTMANN
SSQ-8066
140 mm

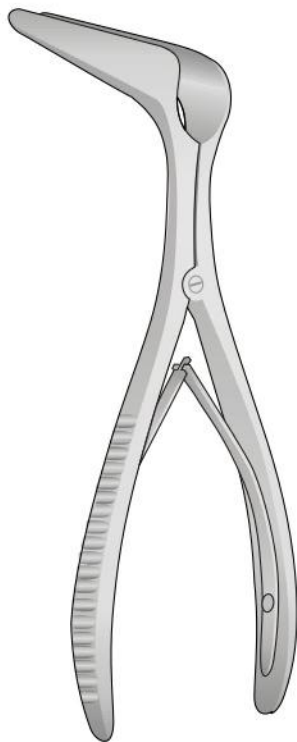

COTTLE
SSQ-8067
150 mm

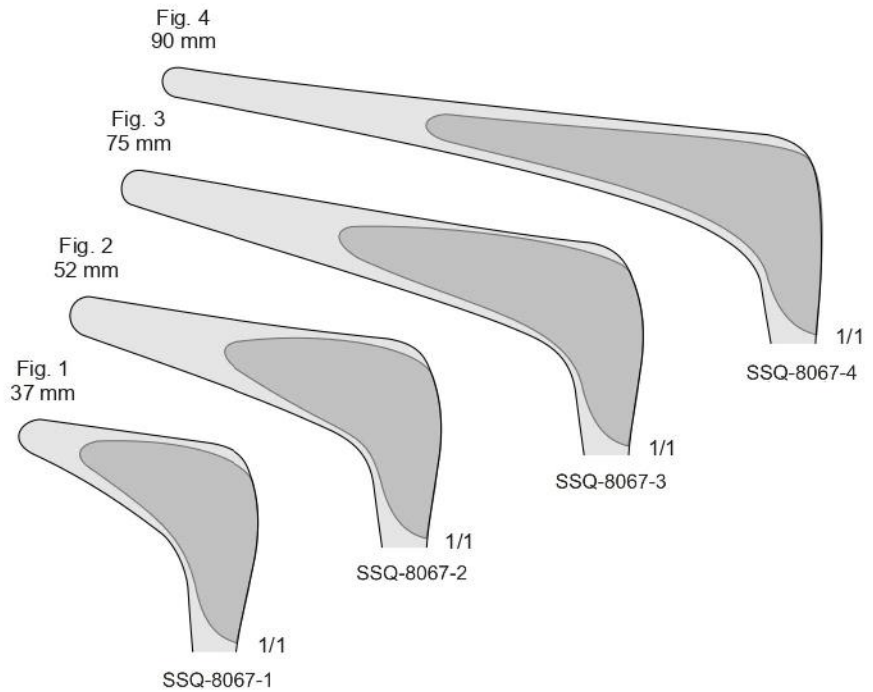

Speculum nasali
Nasal specula
Nasen Spekula
Spéculums nasaux
Espéculos nasales

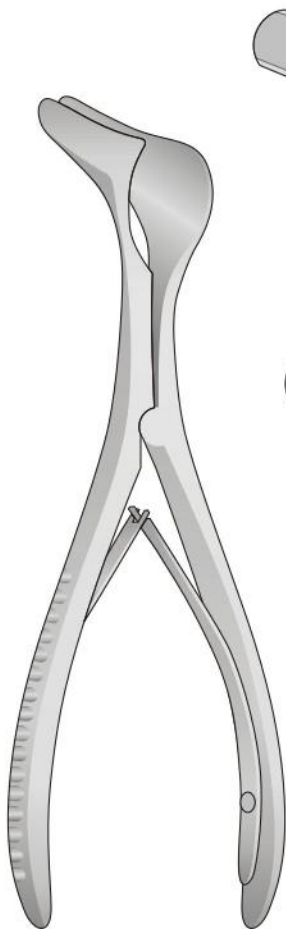

HARTMANN
SSQ-8068

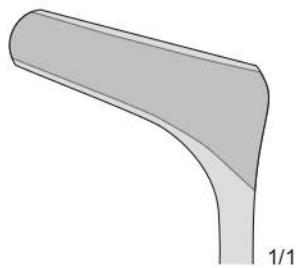

1/1
SSQ-8068-1
160 mm

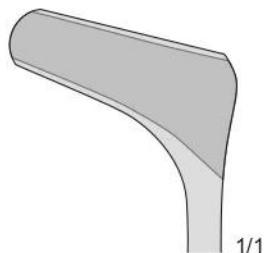

1/1
SSQ-8068-2
160 mm

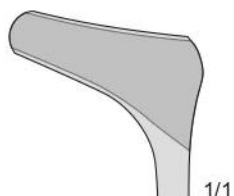

1/1
SSQ-8068-3
155 mm

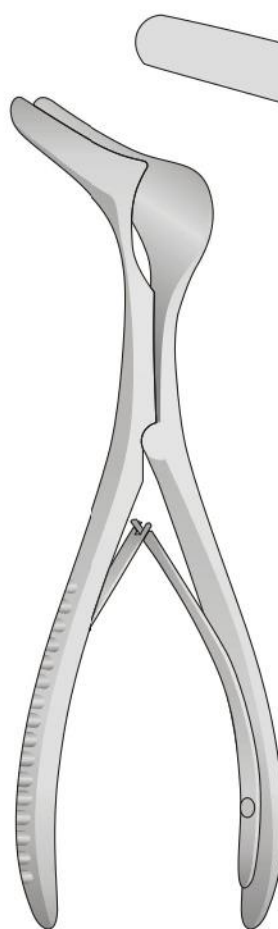

KILLIAN
SSQ-8069

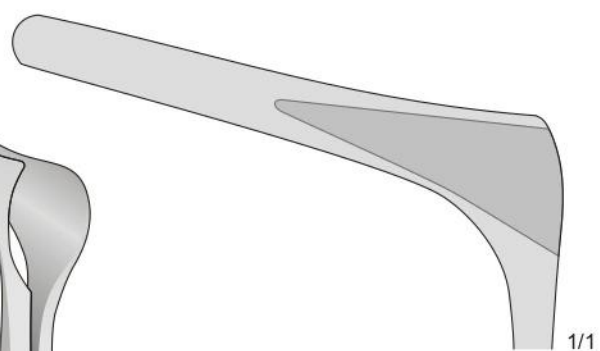

1/1
SSQ-8069-1
150 mm

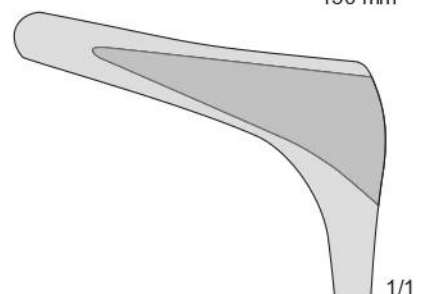

1/1
SSQ-8069-2
140 mm

Speculum nasali
Nasal specula
Nasen Spekula
Spéculums nasaux
Especúlos nasales

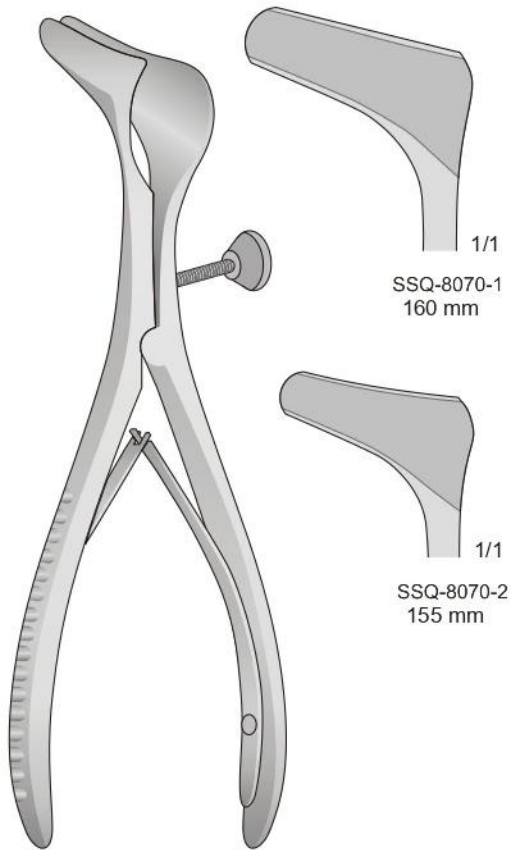

HARTMANN
SSQ-8070

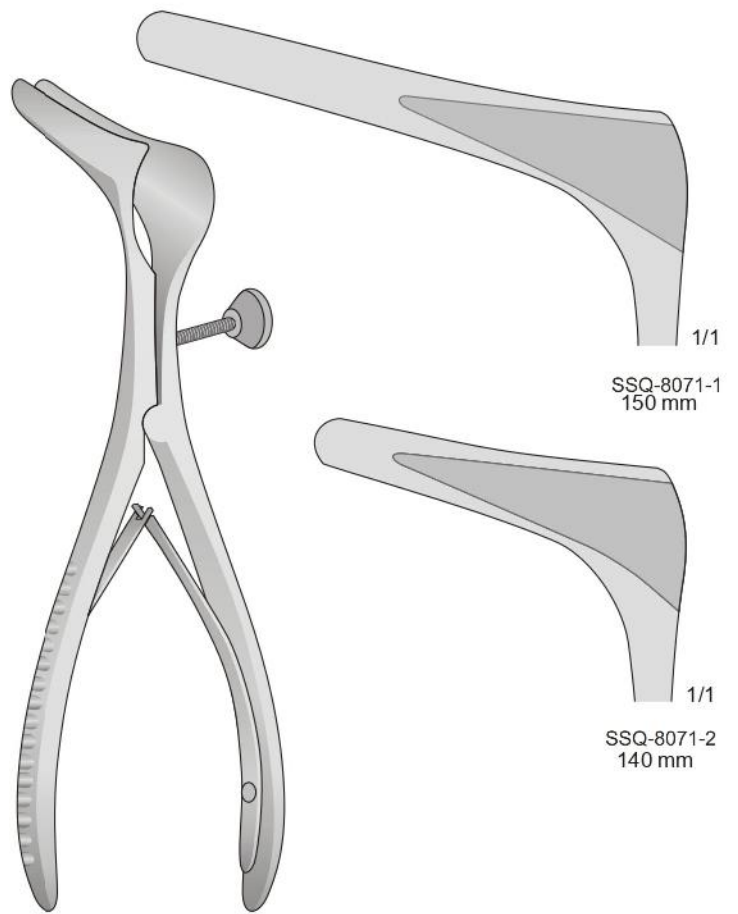

KILLIAN
SSQ-8071

Pinza serranodi
Ear polypus snares
Polypenschnürer
Serre noeuds
Polipòtomos

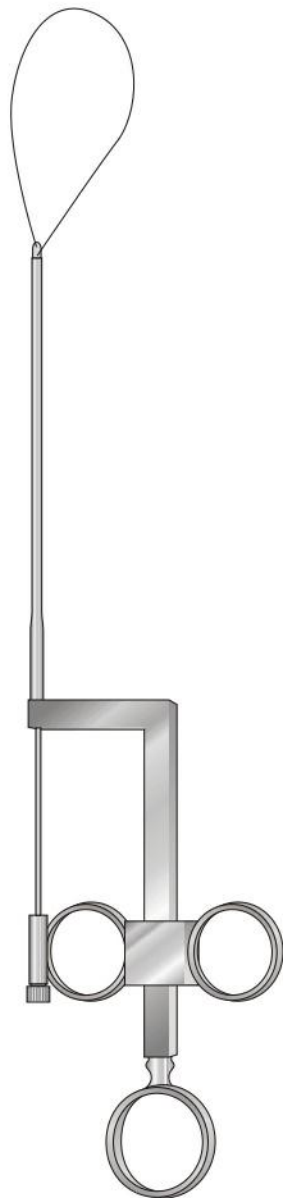

WILDE
SSQ-8072
240 mm

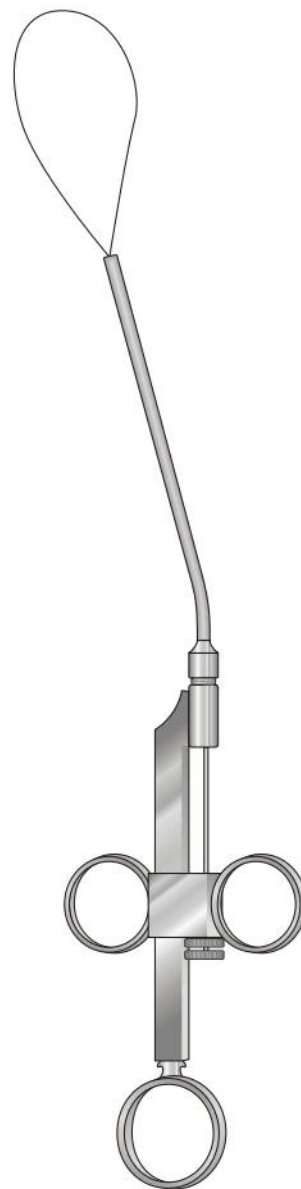

KRAUSE
SSQ-8073
260 mm

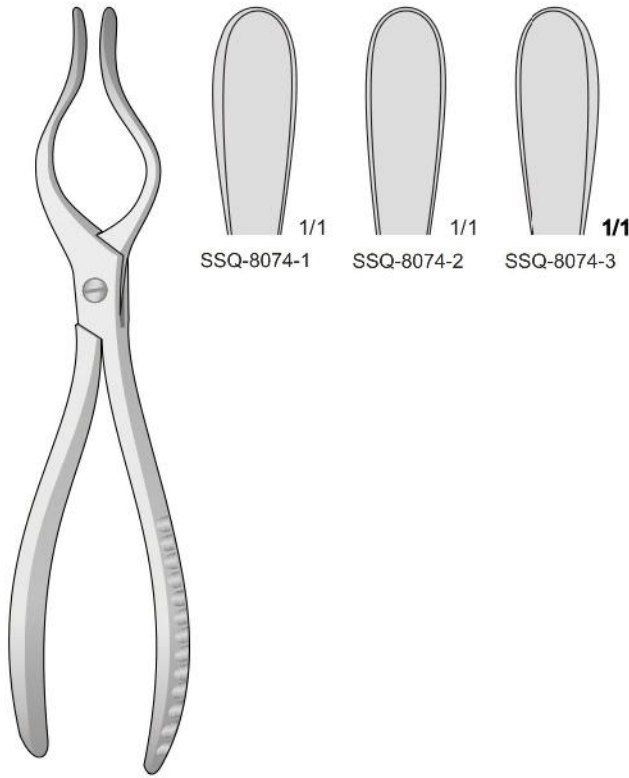

COTTLE-WALSHAM
SSQ-8074
230 mm

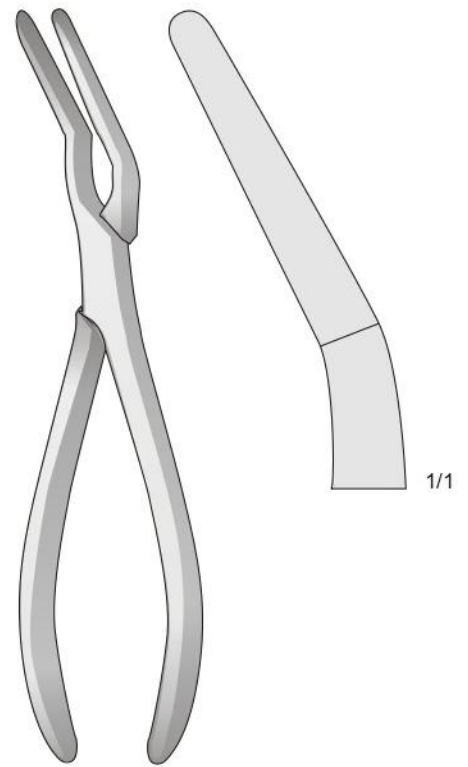

ASH
SSQ-8075
230 mm

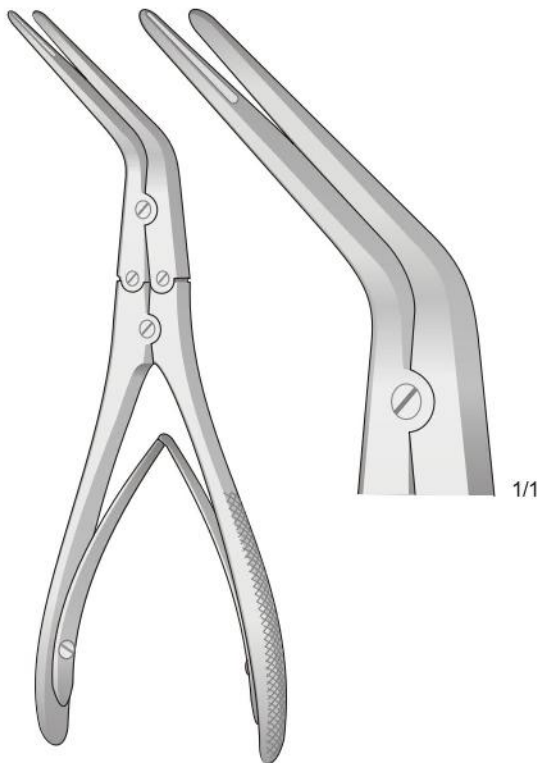

KRESSNER
SSQ-8076
200 mm

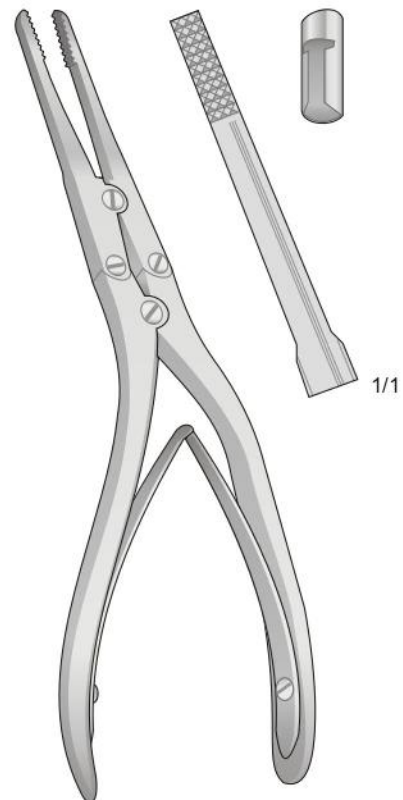

RUBIN
SSQ-8077
210 mm

Strumento per rotture e asportazione frammenti ossei e cartilagine
Bone crusher
Knochen-Knorpelquetsche
Instrument à écraser le cartilage
Instrumento para magullar carilagos

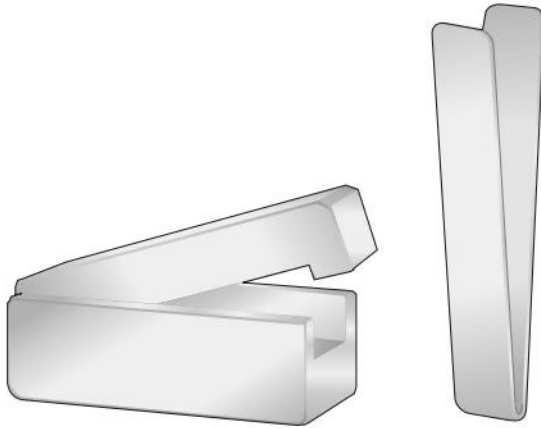

COTTLE
SSQ-8078

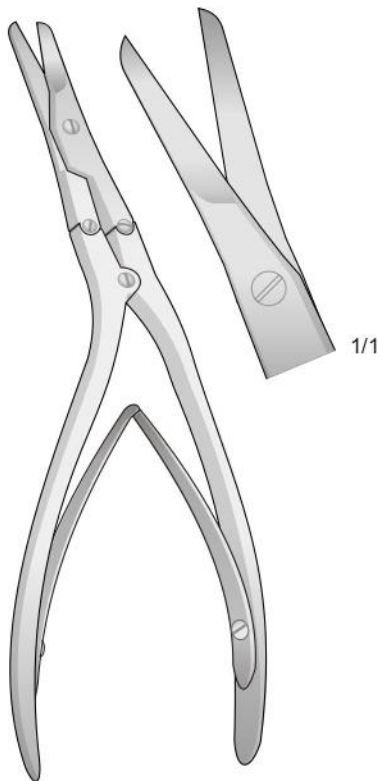

CAPLAN
SSQ-8079
200 mm

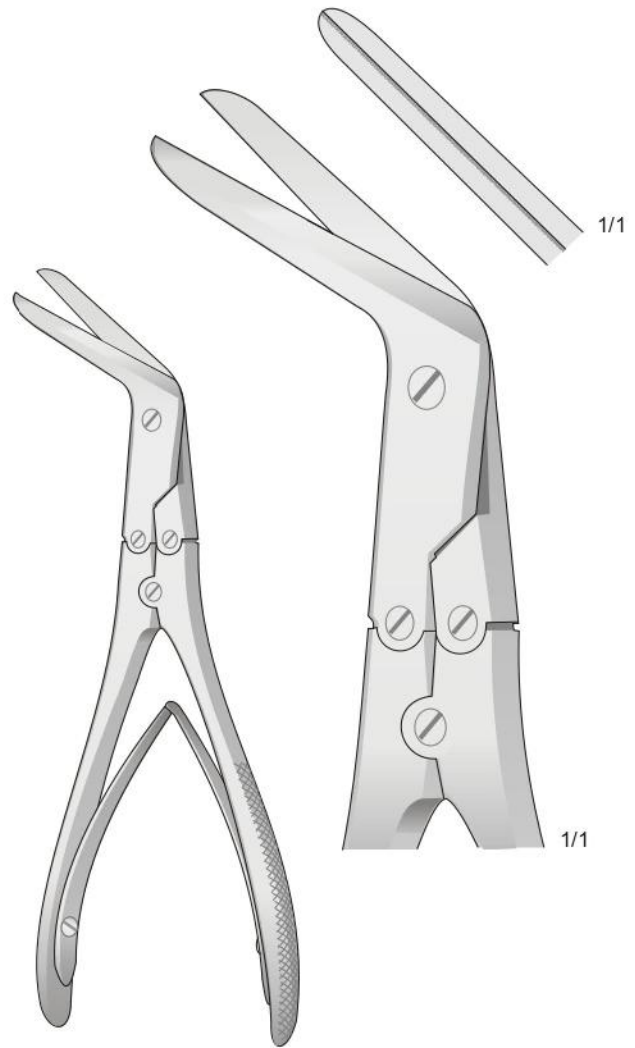

KILLIAN
SSQ-8080
210 mm

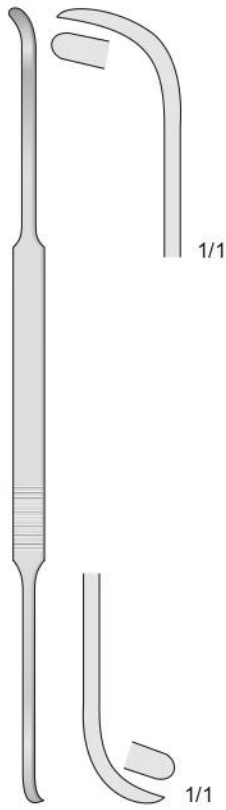

COTTLE
SSQ-8081
230 mm

Acuto/Smusso - Sharp/Blunt
Spitz/Stumpf - Pointu/Mousse
Agudas/Romas

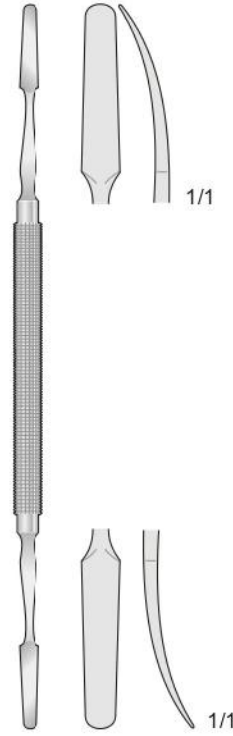

KILIAN
SSQ-8082
180 mm

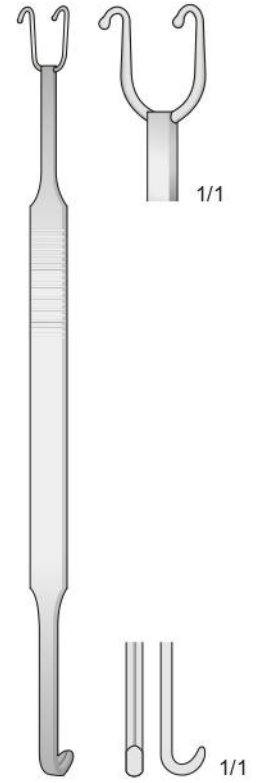

COTTLE-NEIVERT
SSQ-8083
200 mm

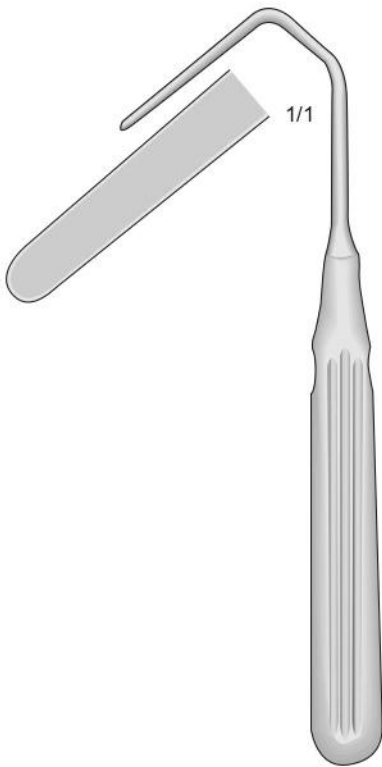

AUFRICHT
SSQ-8084
175 mm

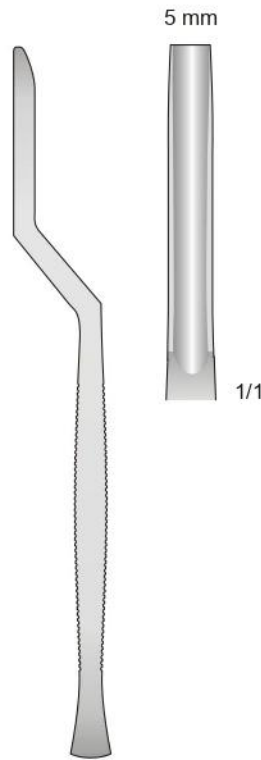

KILIAN
SSQ-8085
160 mm

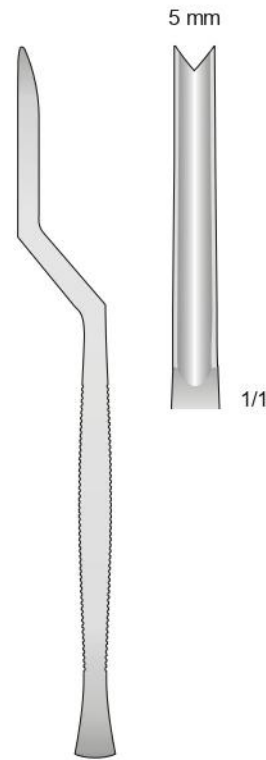

KILIAN-KLAUS
SSQ-8086
160 mm

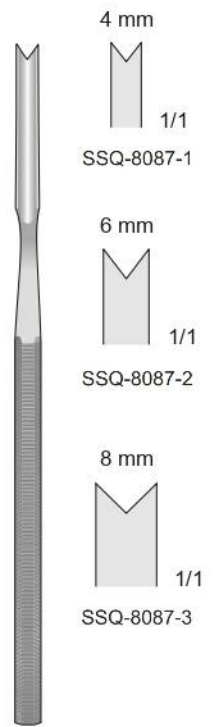

BALLENGER
SSQ-8087
150 mm

Diritta
Straight
Gerade
Droites
Rectas

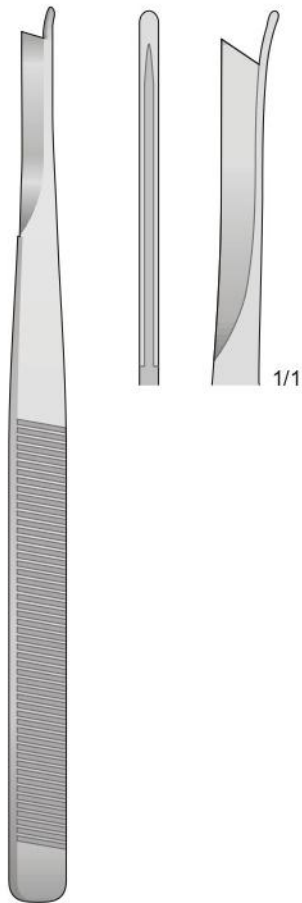

SILVER
SSQ-8088-1
180 mm

Curva, sinistra
Curved, left
Gebogen, links
Courbes à gauche
Curvas a la izquierda

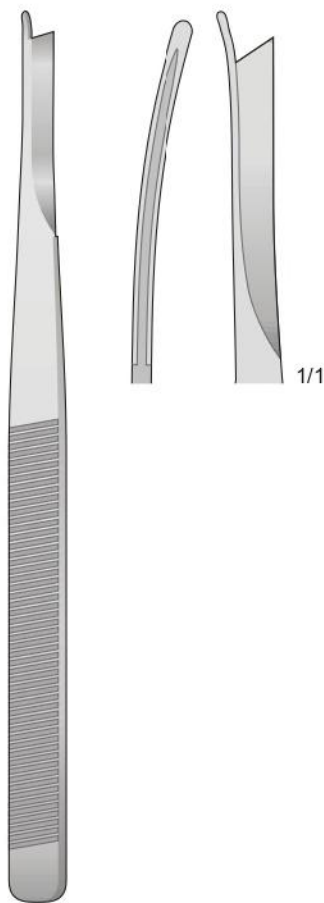

SILVER
SSQ-8088-2
180 mm

Curva, destra
Curved, right
Gebogen, rechts
Courbes à droite
Curvas a la derecha

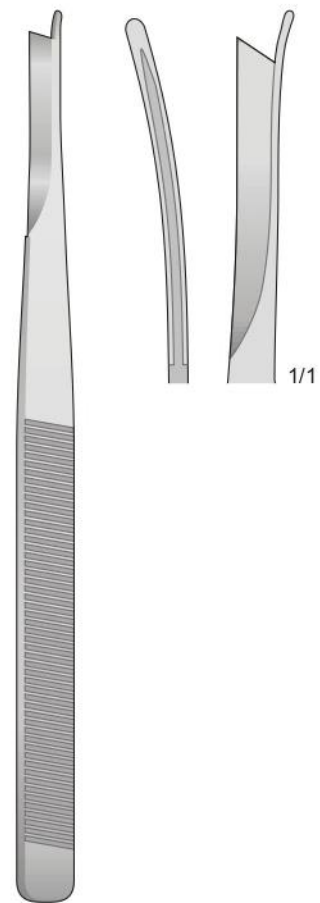

SILVER
SSQ-8088-3
180 mm

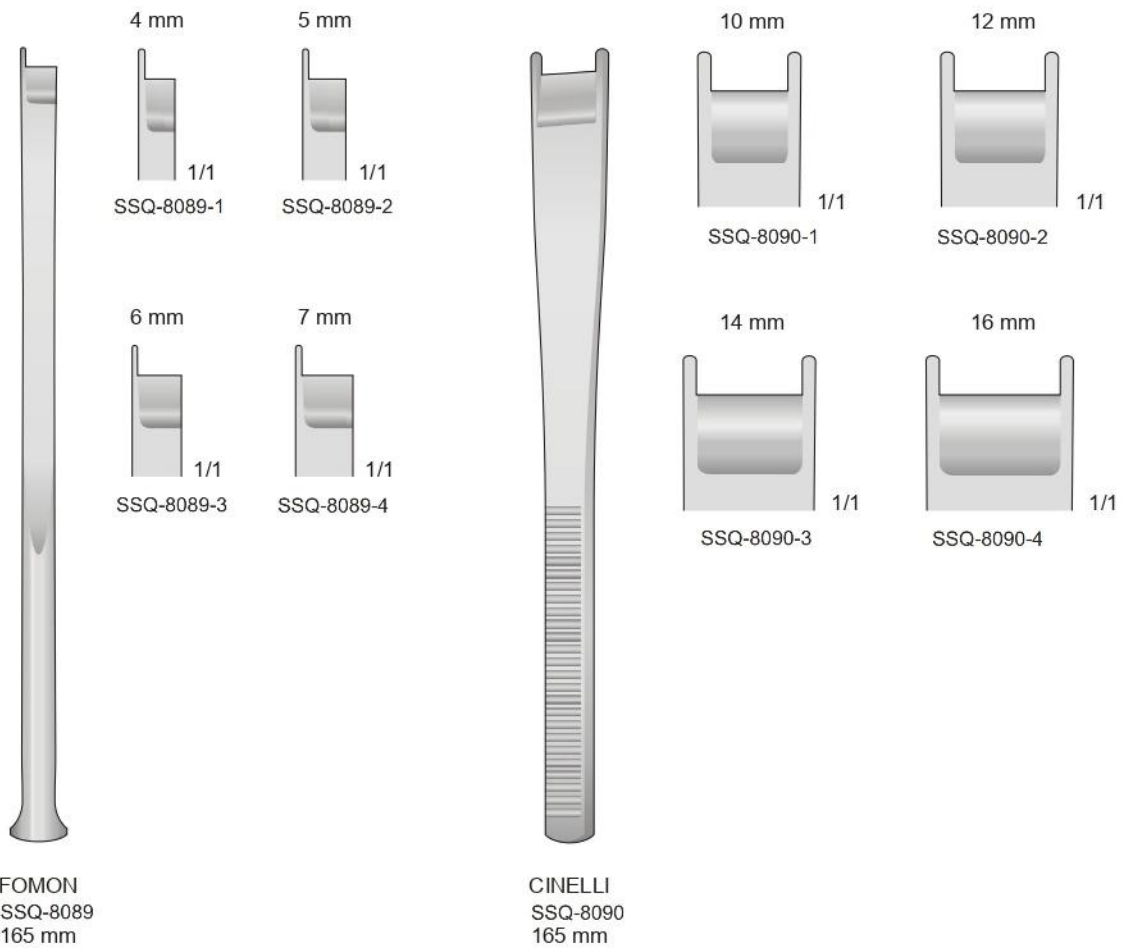

Nasal septum
Osteotomes, graduated

U form

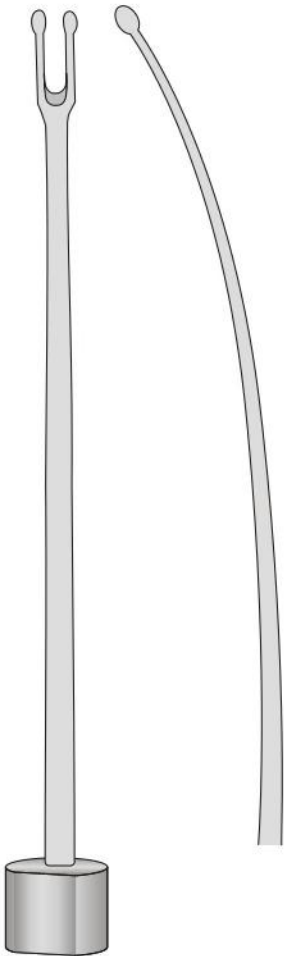

OBWEGESER
SSQ-8091-1
185 mm

V form

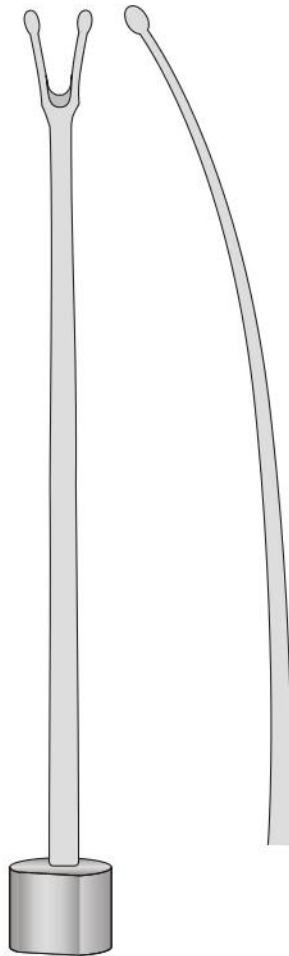

OBWEGESER
SSQ-8091-2
185mm

4 mm

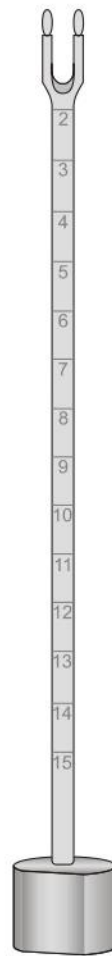

OBWEGESER
SSQ-8091-3
185 mm

6 mm

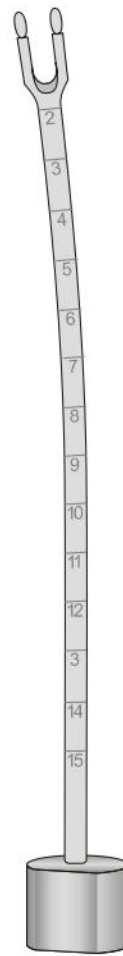

OBWEGESER
SSQ-8091-4
185 mm

8 mm

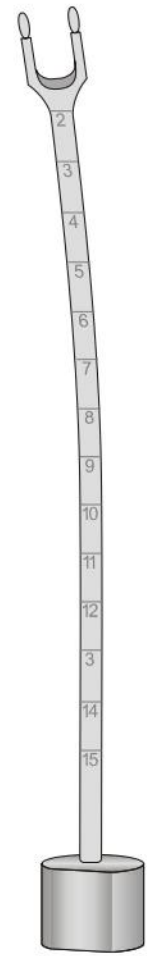

OBWEGESER
SSQ-8091-5
185 mm

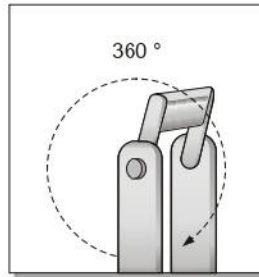

BALLENGER
SSQ-8092
200 mm

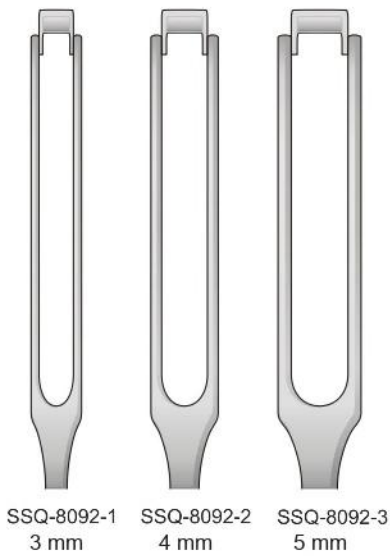

SSQ-8092-1
3 mm
SSQ-8092-2
4 mm
SSQ-8092-3
5 mm

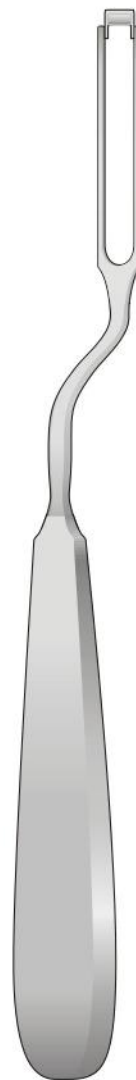

BALLENGER
SSQ-8093
200 mm

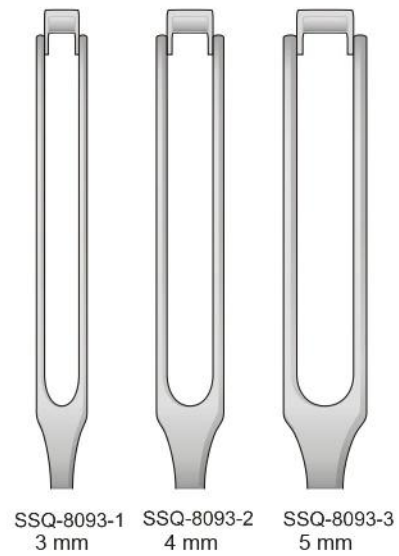

SSQ-8093-1
3 mm
SSQ-8093-2
4 mm
SSQ-8093-3
5 mm

Fig. 67

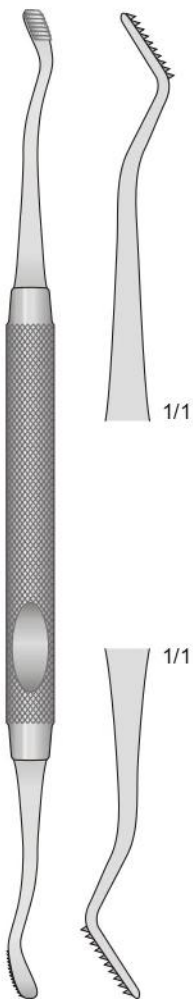

HOWARD
SSQ-8094
180 mm

Fig. 45

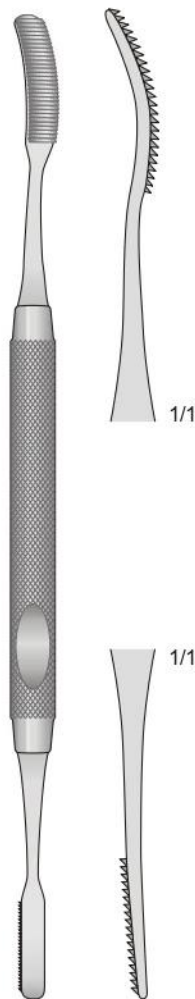

MILLER
SSQ-8095-1
185 mm

Fig. 52

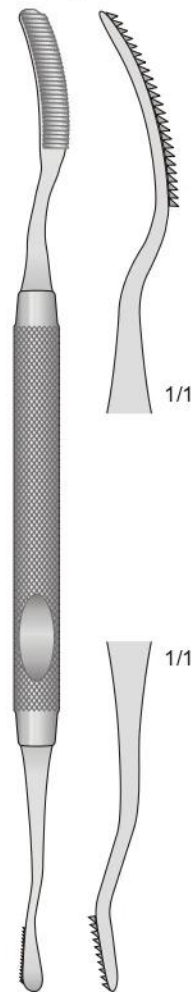

MILLER
SSQ-8095-2
180 mm

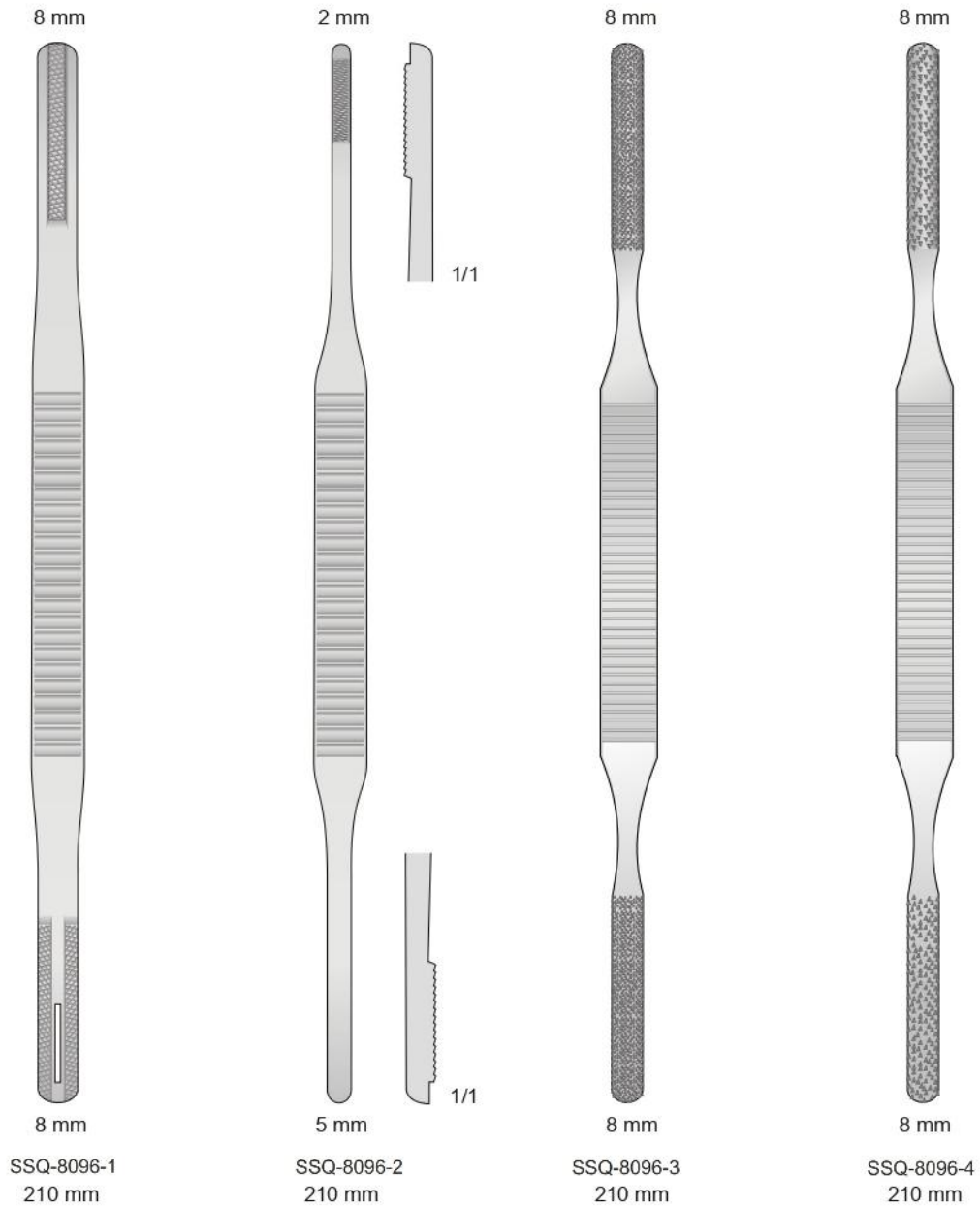

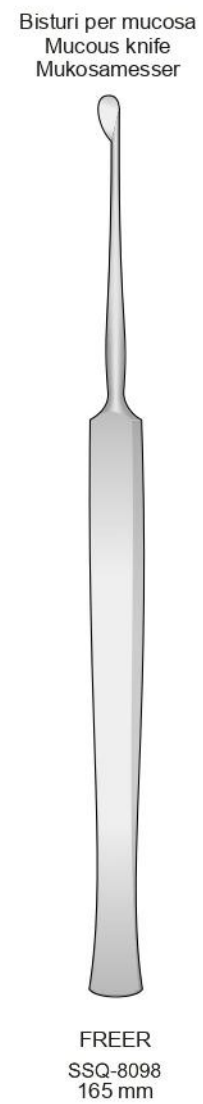
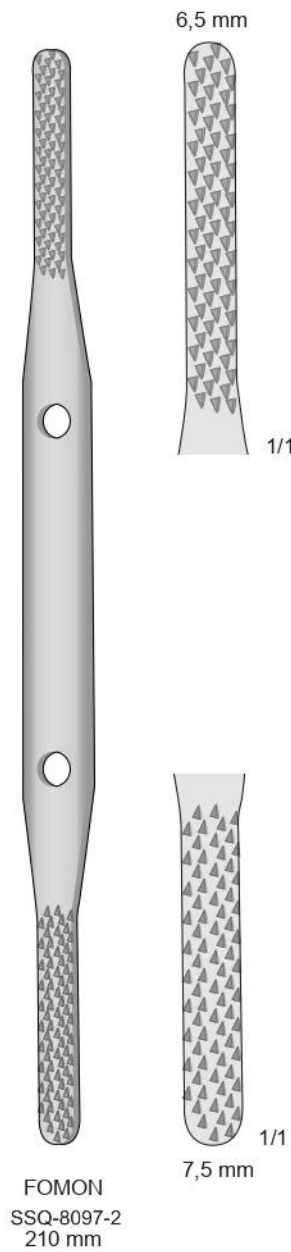
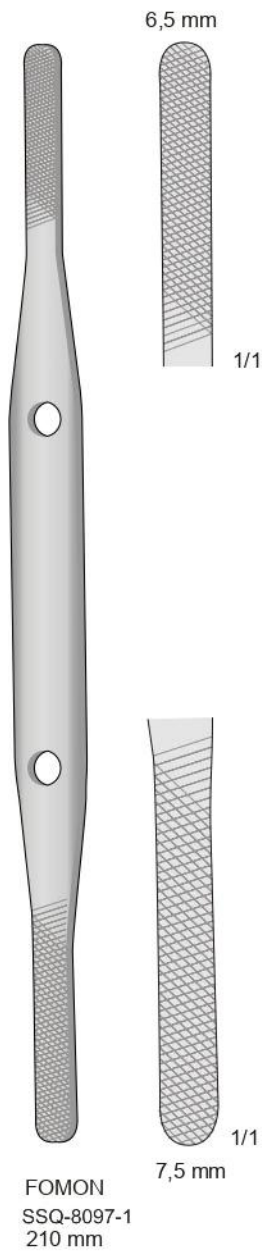

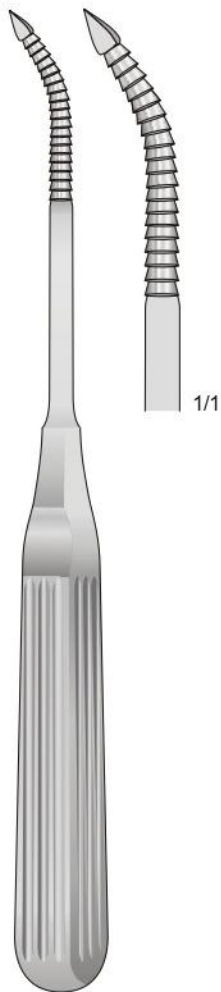

LEWIS
SSQ-8099-1
180 mm

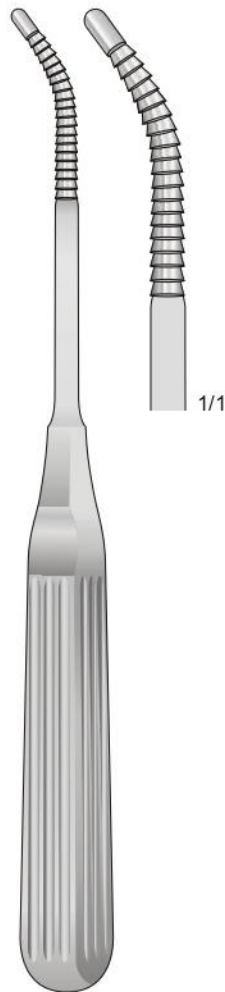

LEWIS
SSQ-8099-2
180 mm



JOSEPH
SSQ-8100
190 mm

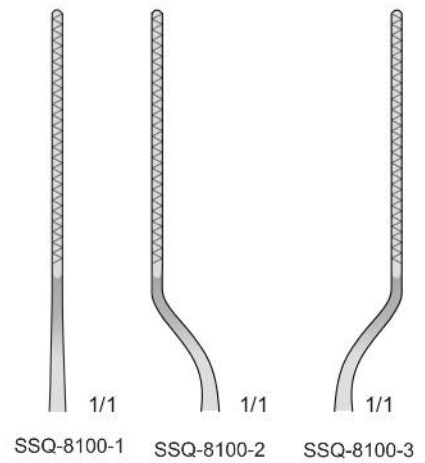

SSQ-8100-1

SSQ-8100-2

SSQ-8100-3

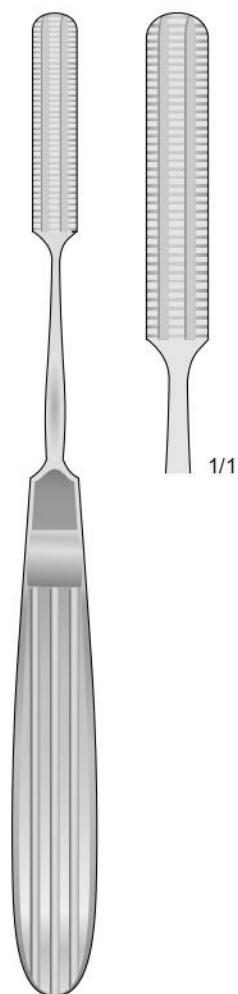

MALTZ
SSQ-8101
180 mm

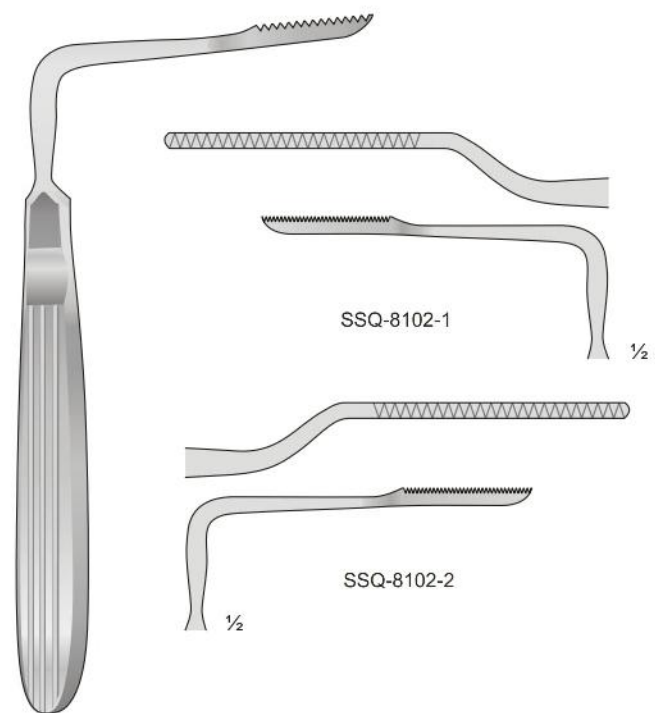

JOSEPH
SSQ-8102
135 mm

Uncino per arco zigomato
Zigoma hook
Haken-Jochbogenahle

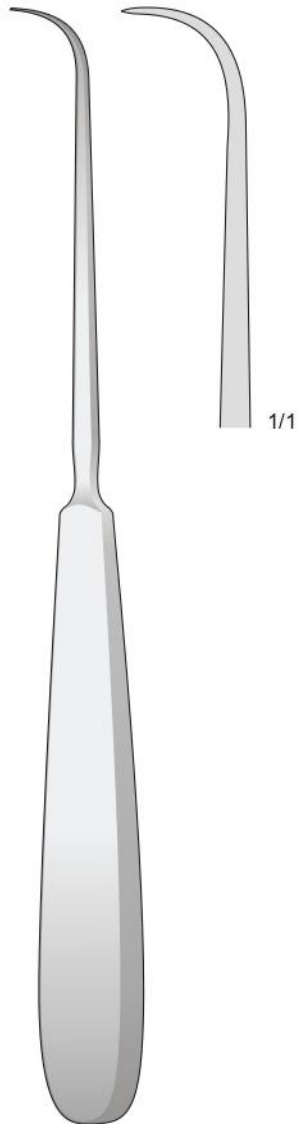

SSQ-8103
200 mm

Curette taglianti
Scharfe Küretten
Curettes Tranchantes



COAKLEY
SSQ-8104
170 mm

Fig. 1



1/1

SSQ-8104-1

Fig. 2



1/1

SSQ-8104-2

Fig. 3



1/1

SSQ-8104-3

Fig. 4



1/1

SSQ-8104-4

Fig. 5



1/1

SSQ-8104-5

Fig. 6



1/1

SSQ-8104-6

Adenotomi - Adenotomie - Adenoidectomy
Adénoïdes - Adenoides

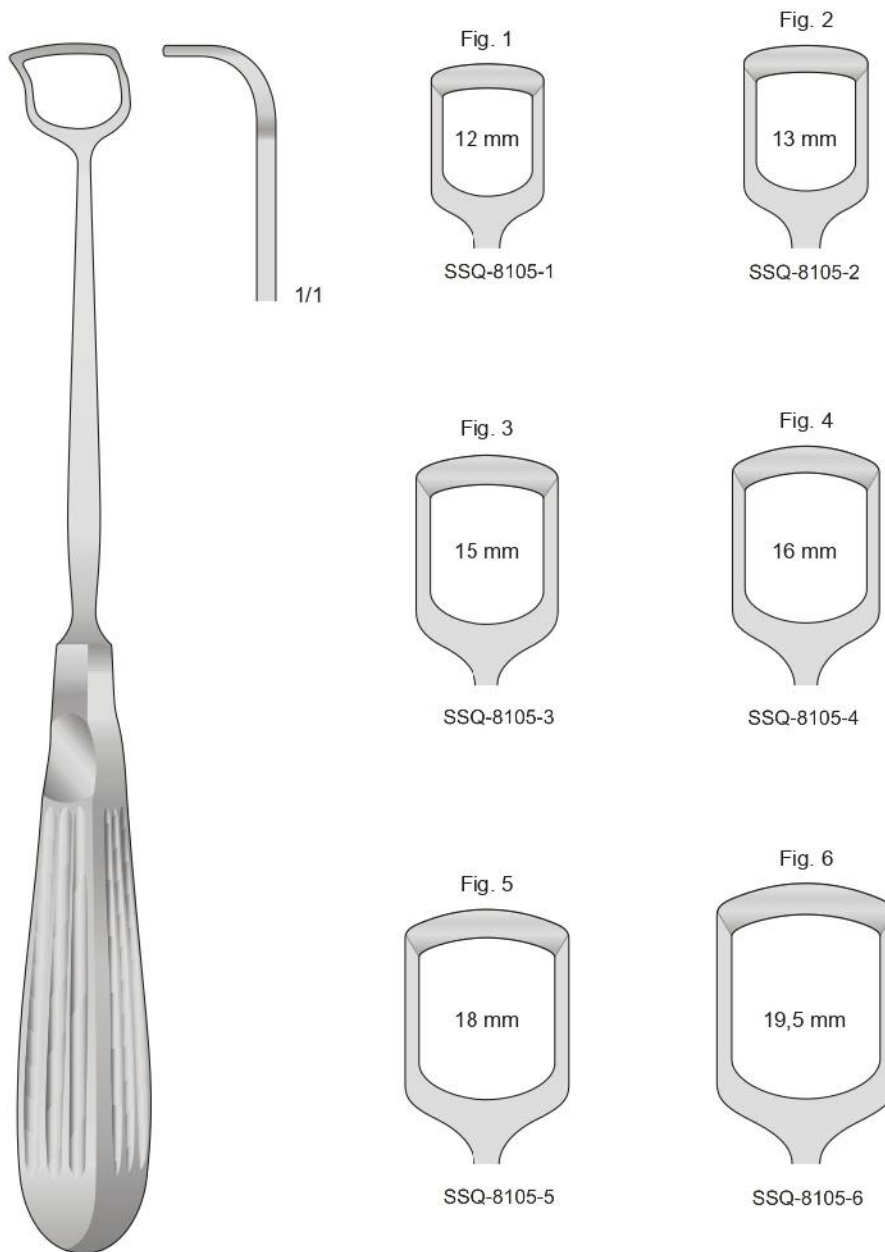

BECKMANN
SSQ-8105
220 mm

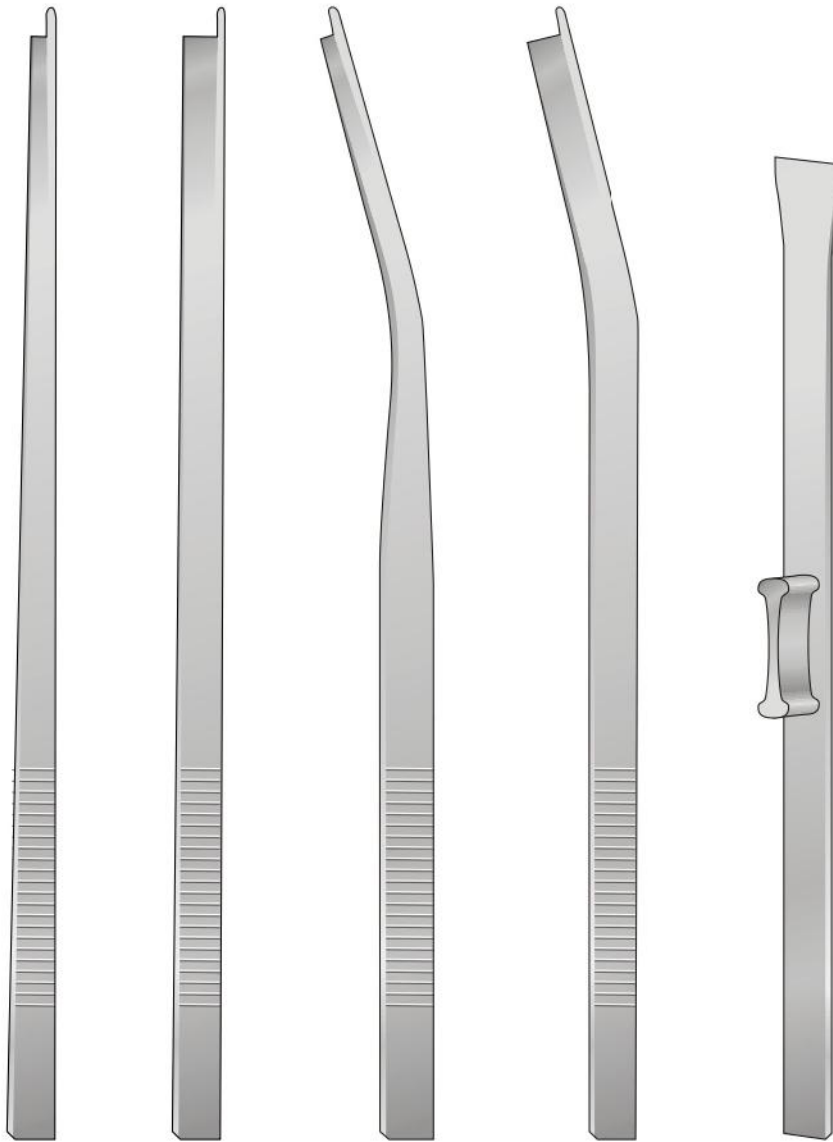

Osteotomi, Osteotomes
Osteotome, Ostéotomes, Osteótomos

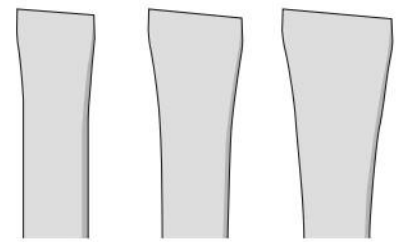

SSQ-8800-1 10 mm
SSQ-8800-2 12 mm
SSQ-8800-3 14 mm



SSQ-8106-1
200 mm

SSQ-8106-2
200 mm

SSQ-8106-3
200 mm

SSQ-8106-4
200 mm

RUBIN
SSQ-8107
180 mm

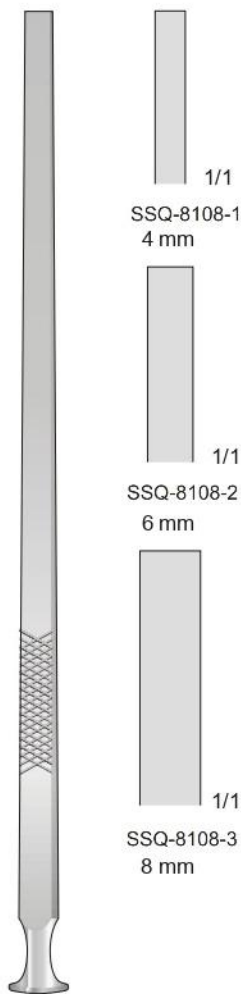

EPKER
SSQ-8108
180 mm

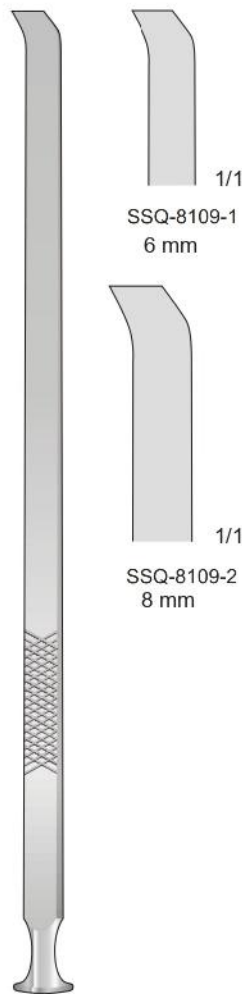

EPKER
SSQ-8109
180 mm

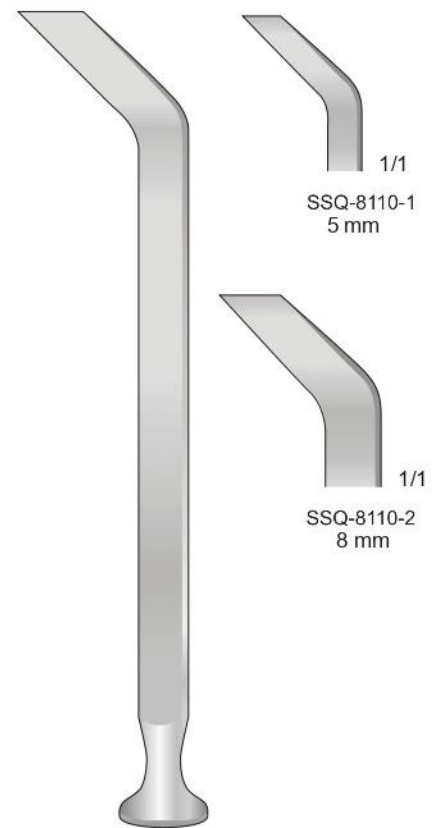

SPLIT
SSQ-8110
150 mm

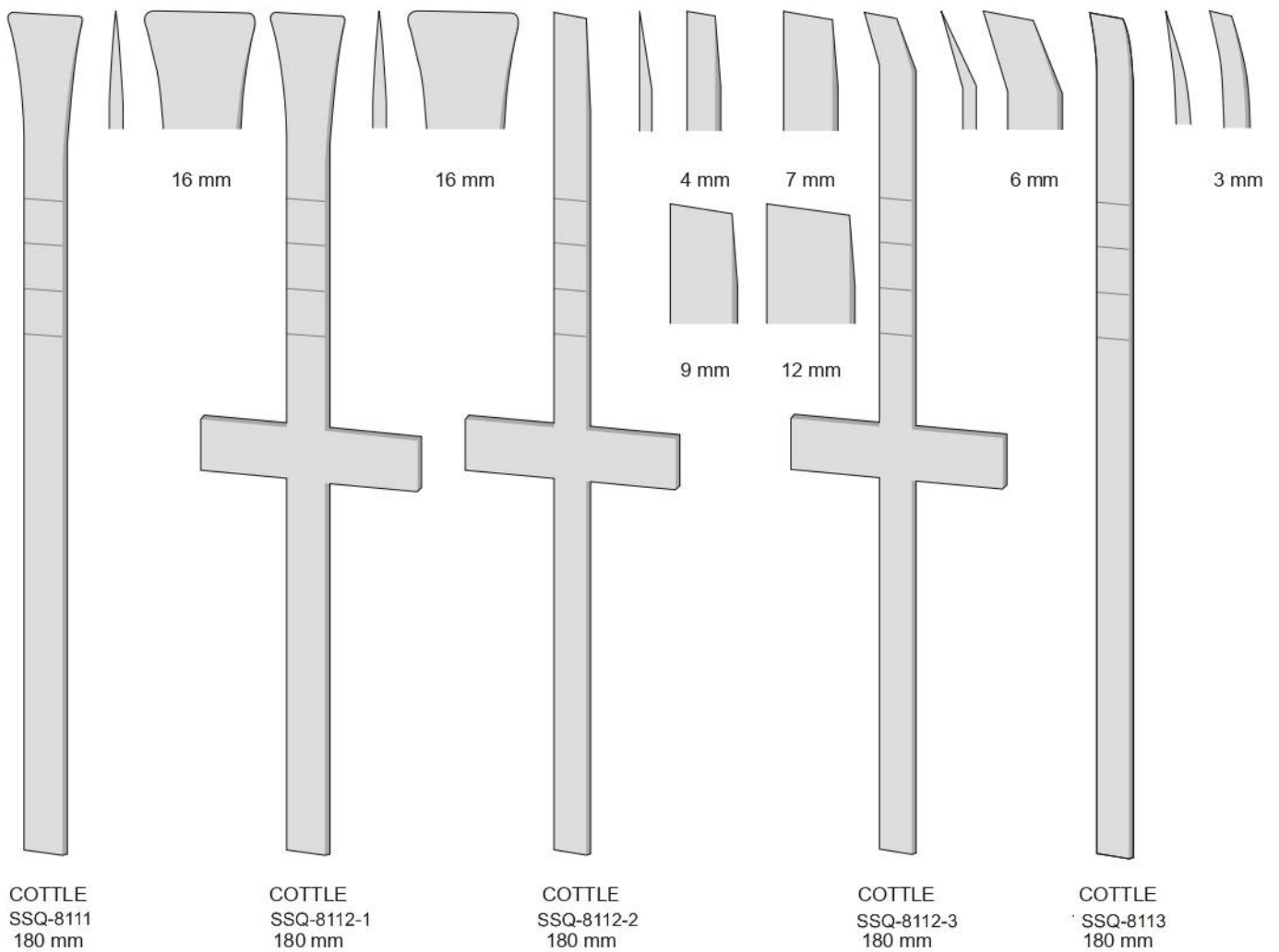

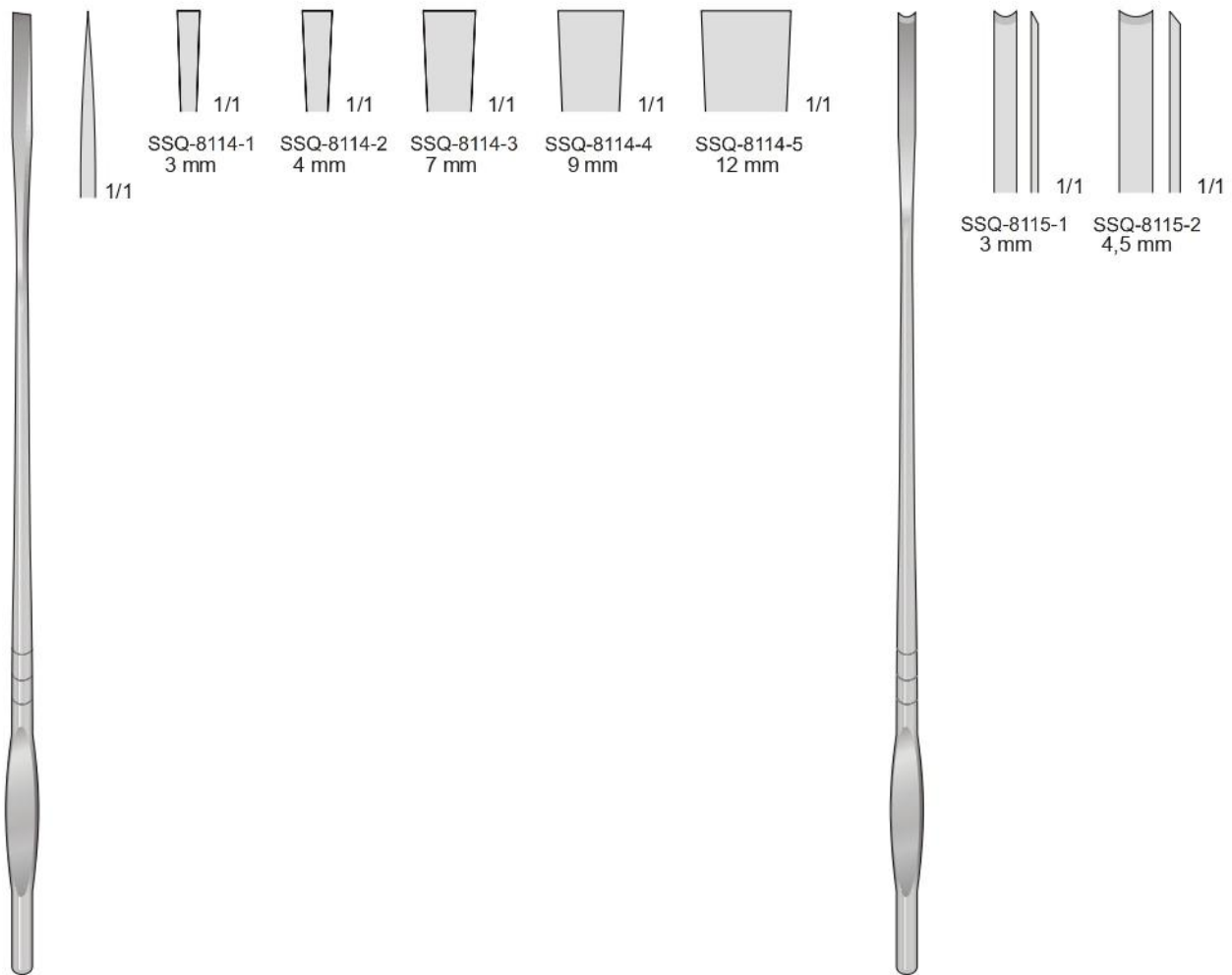

SSQ-8114
190 mm

SSQ-8115
190 mm

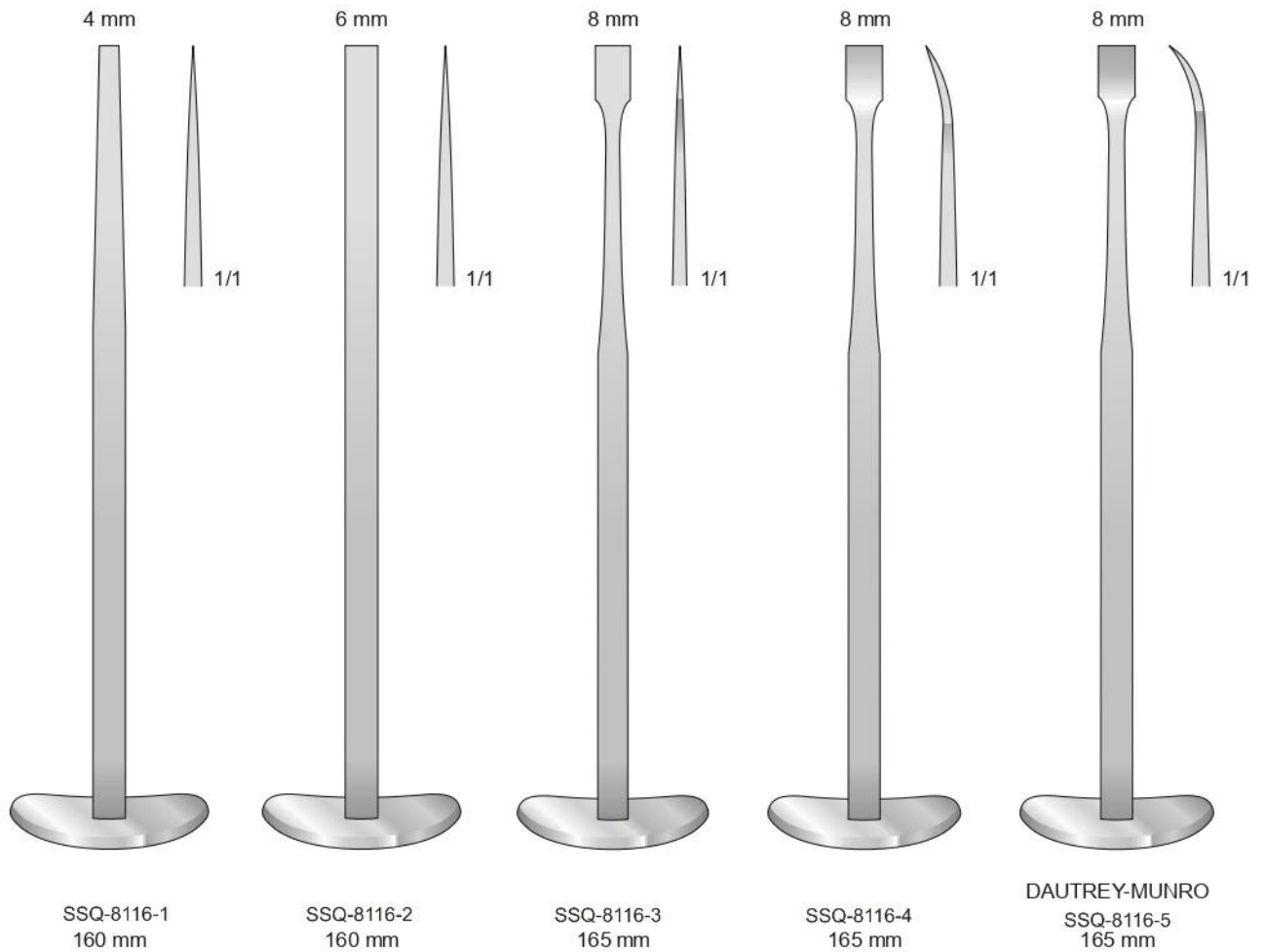

Osteotomi diritti graduati

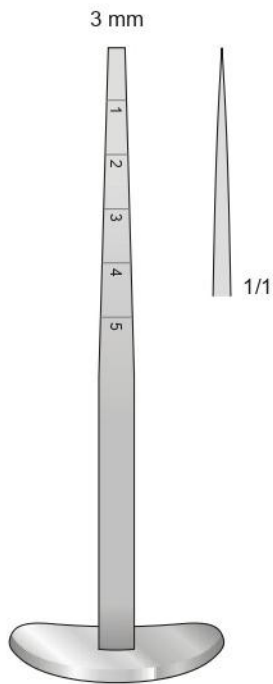

SSQ-8117-1
115 mm

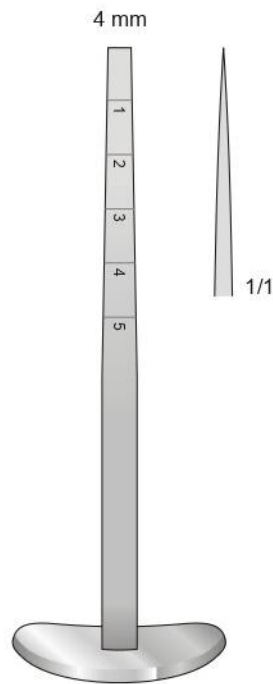

SSQ-8117-2
115 mm

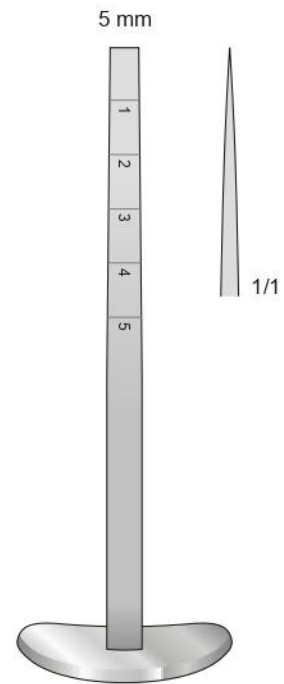

SSQ-8117-3
115 mm

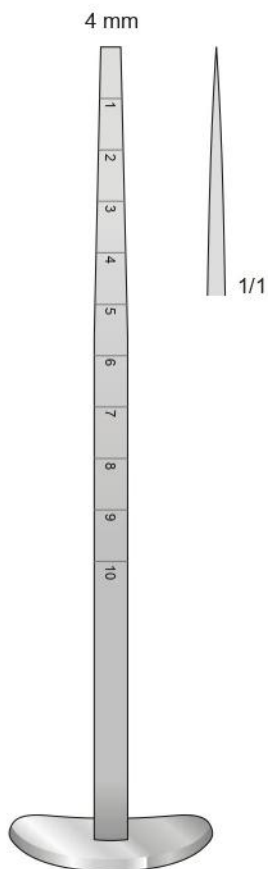

SSQ-8117-4
160 mm

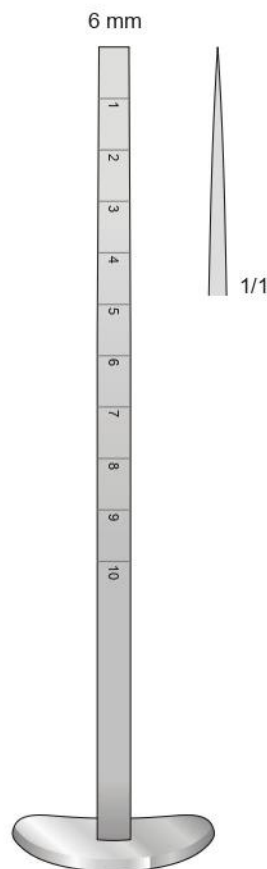

SSQ-8117-5
160 mm

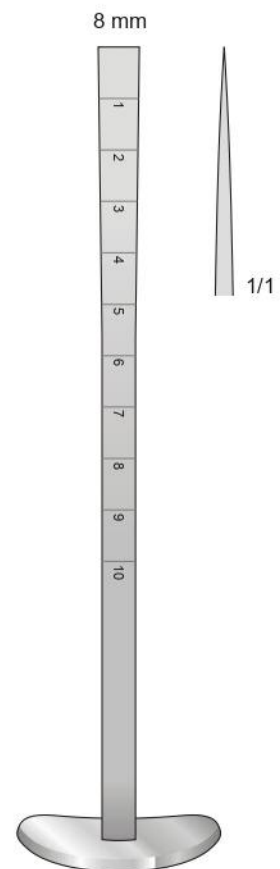

SSQ-8117-6
160 mm

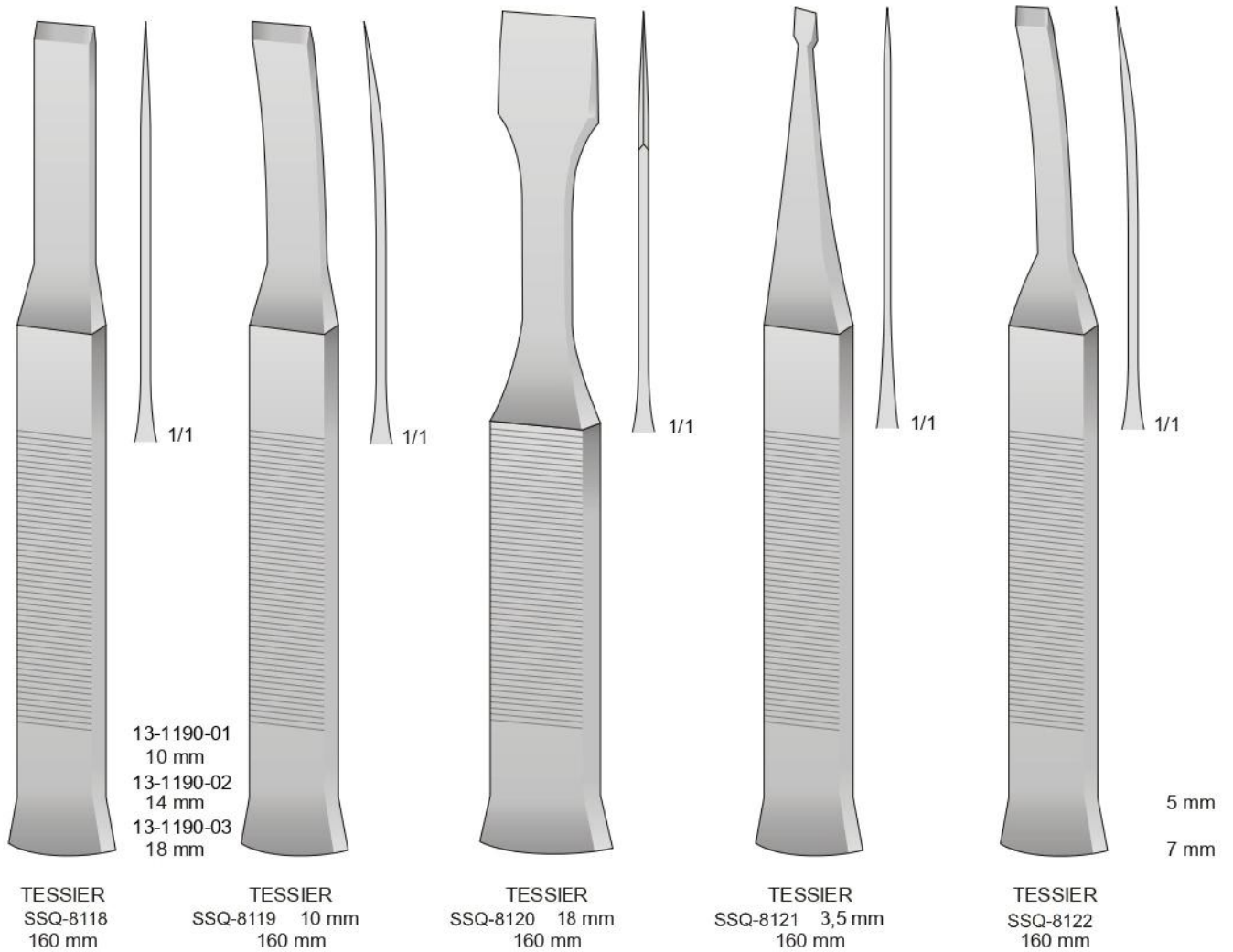

Osteotomi nasali
Nasal Osteotomes
Nasen Osteotome
Ostéotomes nasaux
Osteotomos nasales

Manico in ferrozell
With Ferrozell Handle
Mit Ferrozell-Griff
Avec poignée en Ferrozell
Con mango de Ferrozell

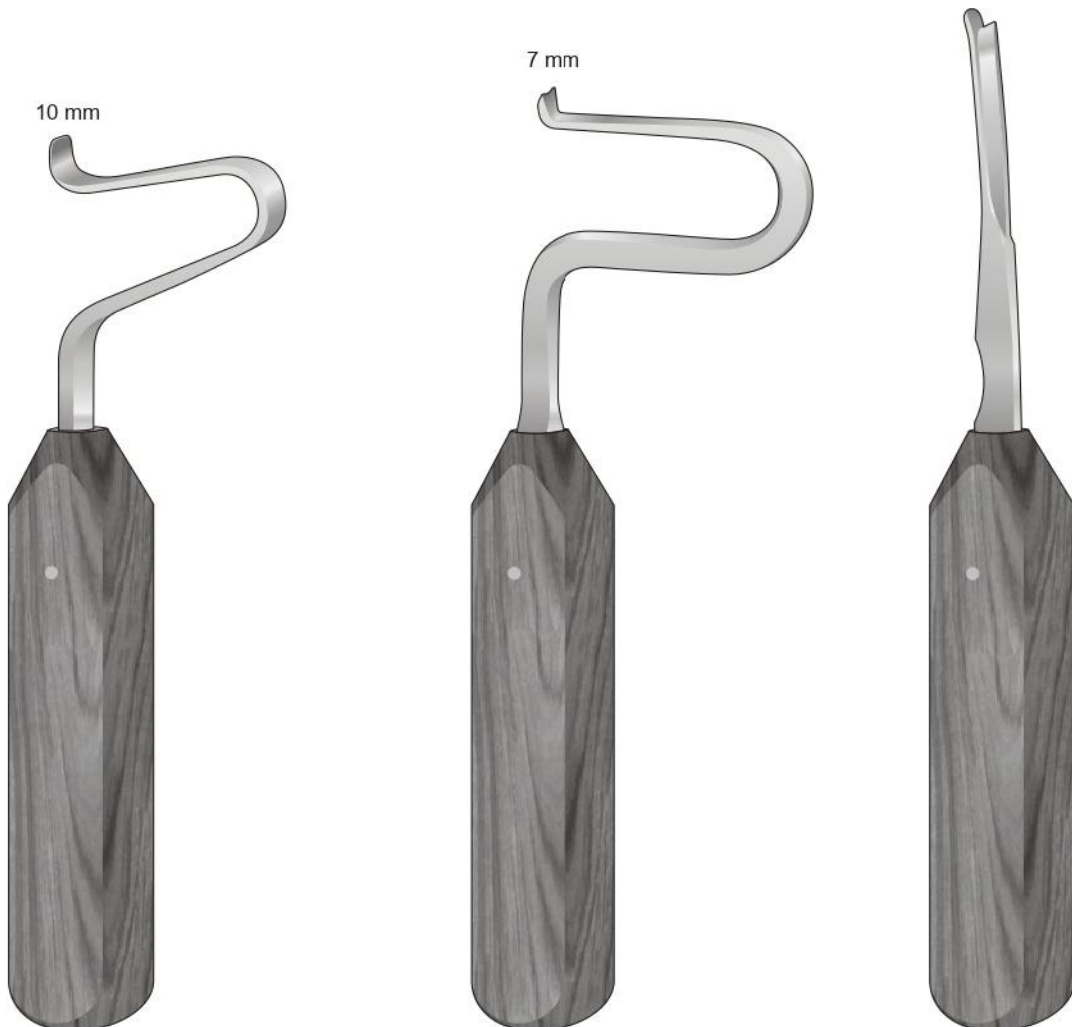

SSQ-8123-1
170 mm

SSQ-8123-2
190 mm

SSQ-8124-1 destro - R
SSQ-8124-2 sinistro - L
205 mm

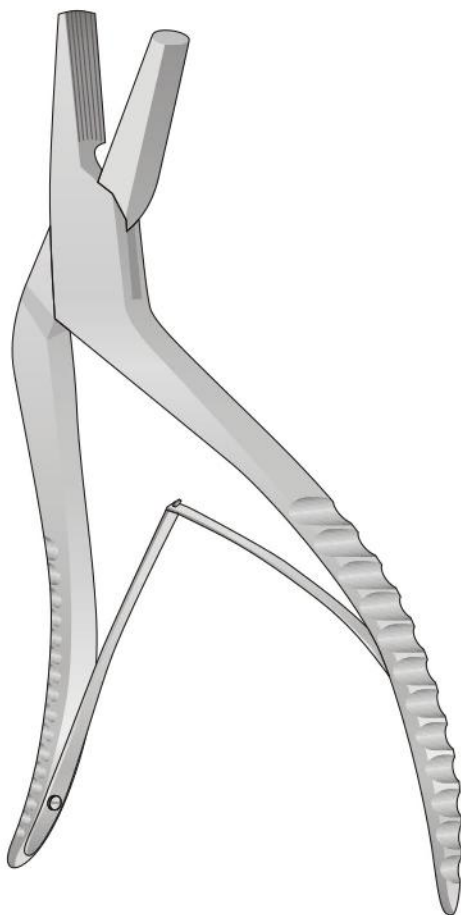

TESSIER
SSQ-8125
195 mm

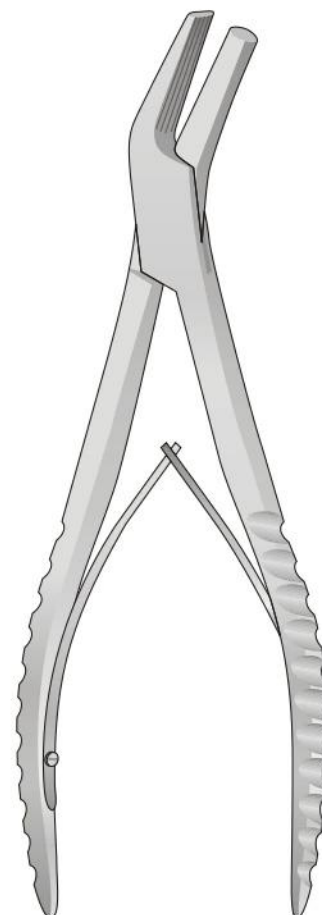

TESSIER
SSQ-8126
220 mm

Bone cutters
Macina osso

SSQ-8127-1 Manico ad innesto cm. 19,5
Flexible handle
Abnehmbarer Griff

SSQ-8127-2 Vaschetta porta-osso con presa
Knochenbehälter
Container for bones

SSQ-8127-3 Tassello spingi-osso superiore
Oberer Knochen-drücker

SSQ-8127-4 Grattugia per CIPS fine #1
Reibe für GIPS, fein

SSQ-8127-5 Grattugia per CIPS grossi #2
Reibe für GIPS, grob

SSQ-8127
Comprende una
sola grattugia

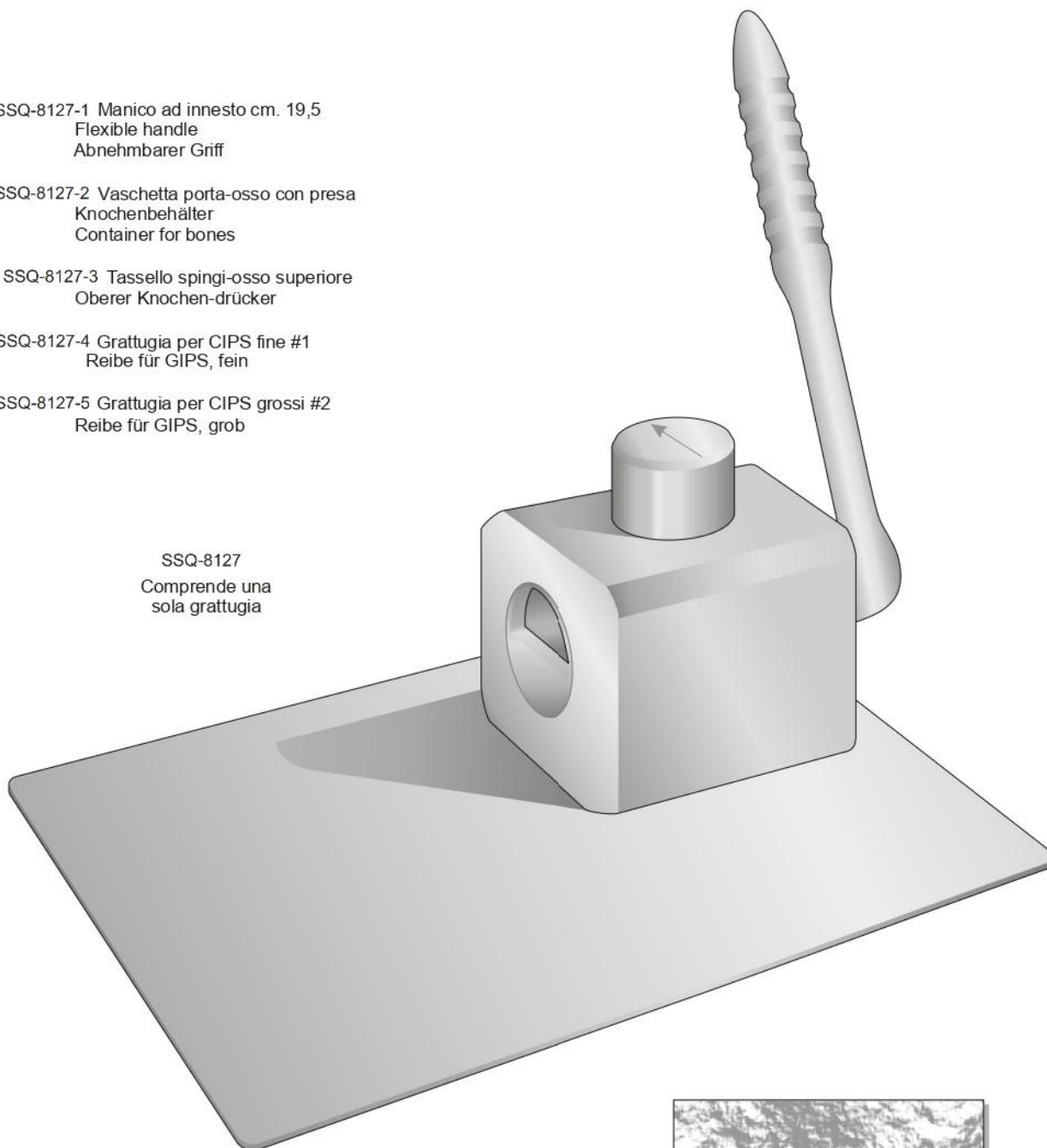

GABON
SSQ-8128
235 x 160 x 100 mm
Kg 4,5

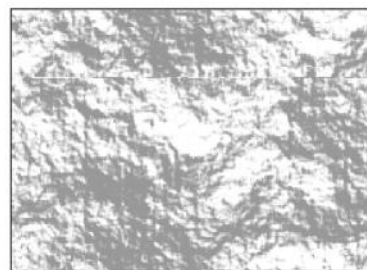

Cips macinato



Manufacturer & Exporter Of Surgical Instruments.

☎ +92-52-3532361
☎ +92 (302) 775 4954 | +92 (301) 618 3770
✉ ssqintl1@gmail.com | info@ssqintl.com
📍 Kotli Loharan West, Near Chella, Sialkot - Pakistan



www.ssqintl.com