

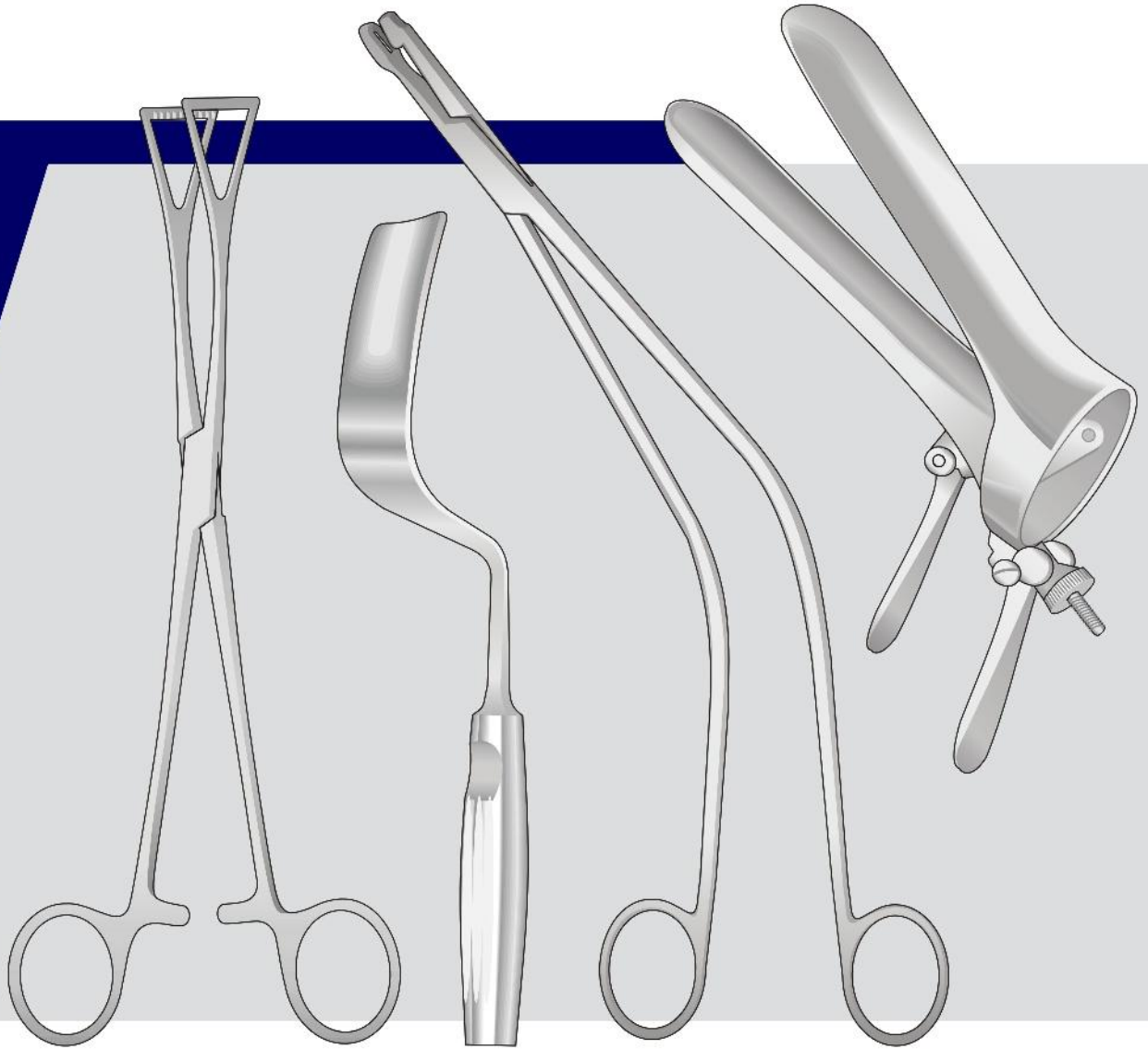

INTERNATIONAL

LET'S SHARE ABOUT SURGERY



Gynecology | Urology Instruments

**Surgical
Instruments
Catalogue**



www.ssqintl.com

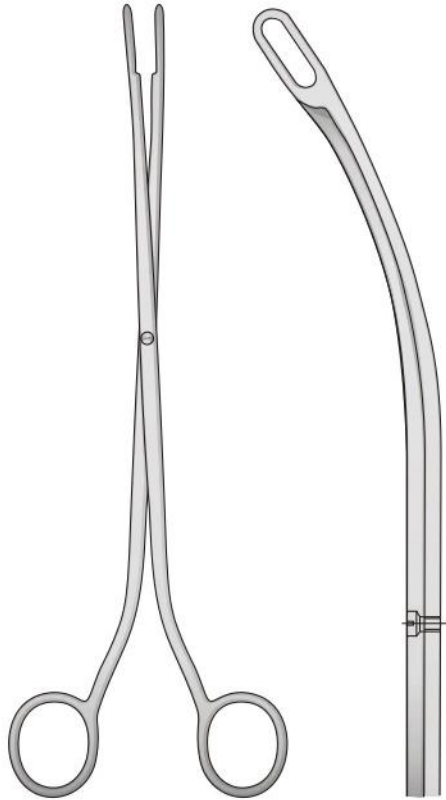

DESJARDINS
SSQ-7001
225 mm

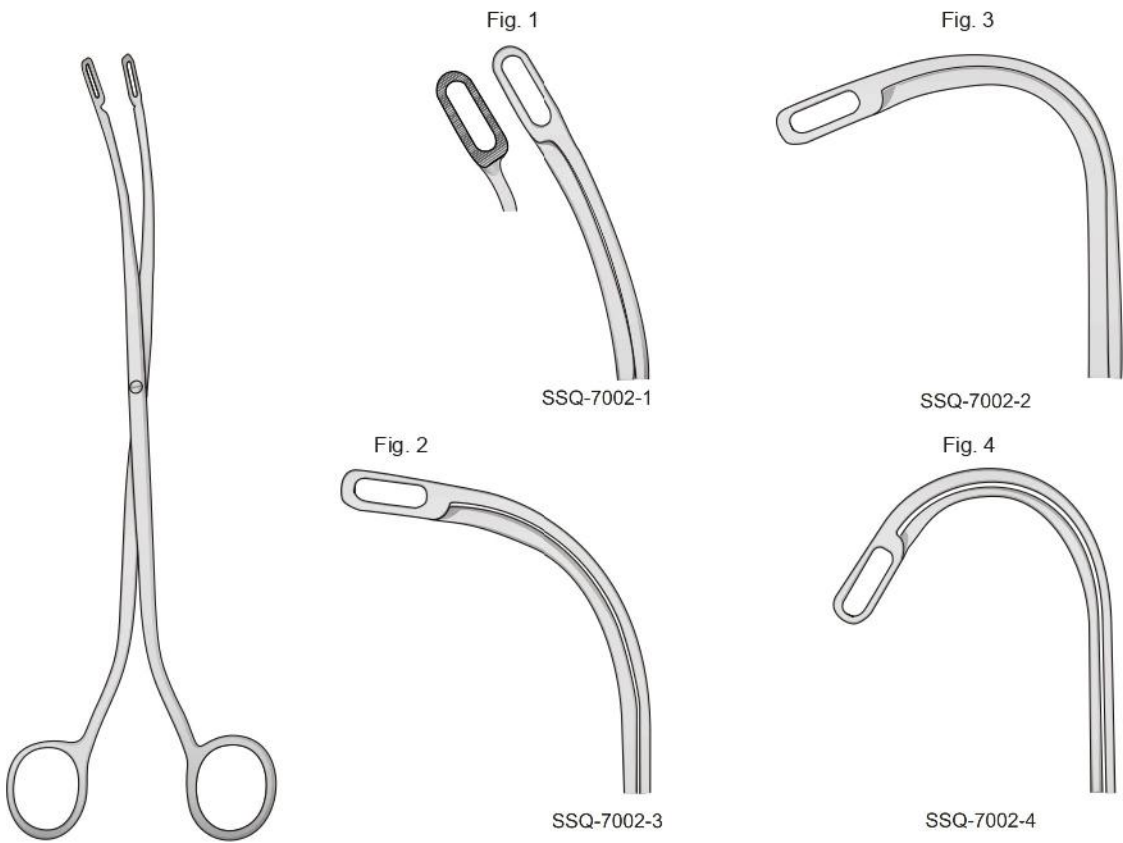
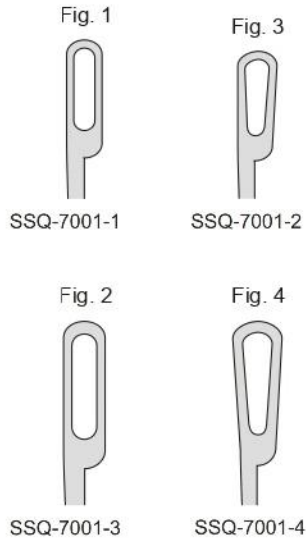

RANDALL
SSQ-7002
225 mm

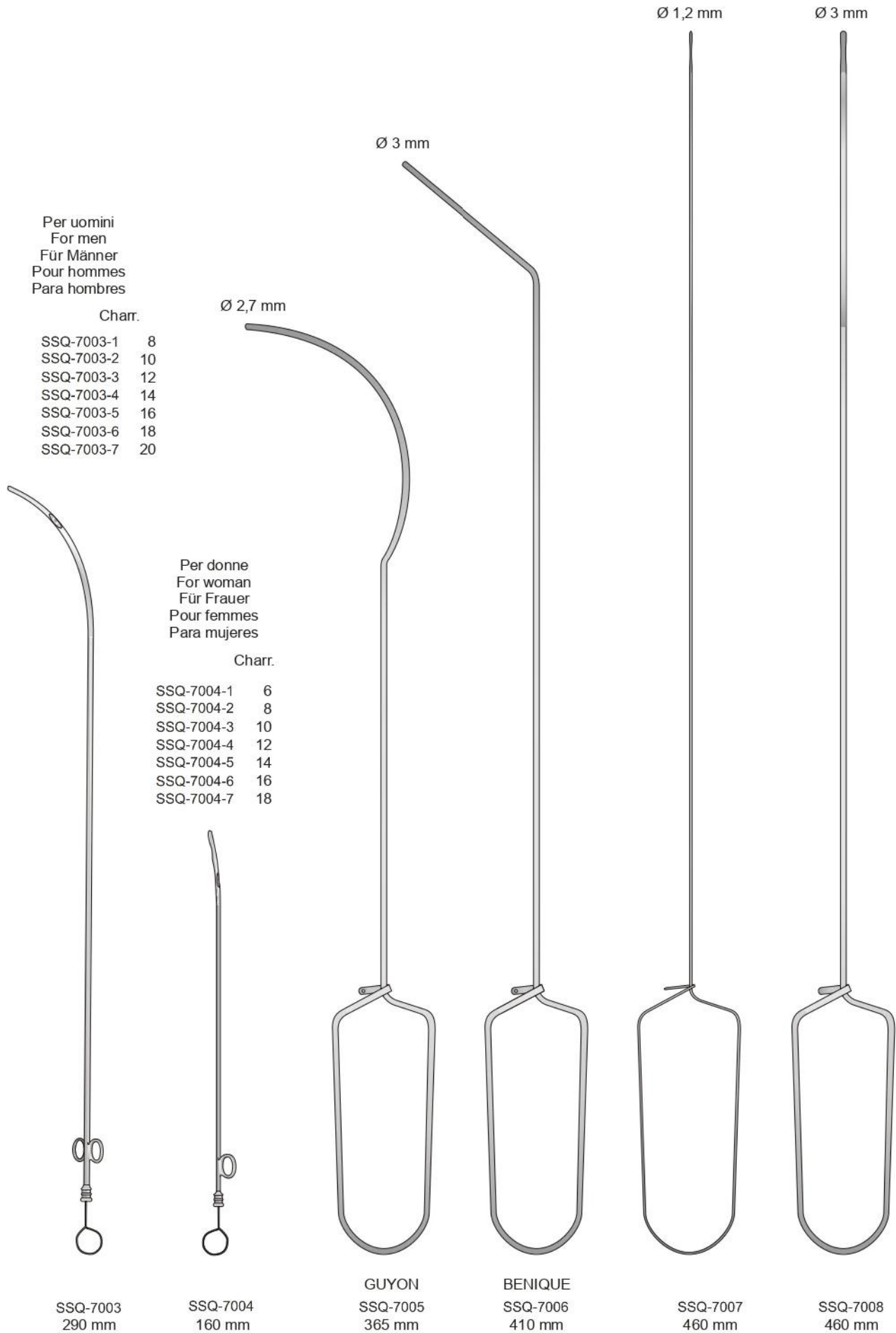

SSQ-7009-1 - 190 mm - Ø 3 mm
 SSQ-7009-2 - 190 mm - Ø 4 mm
 SSQ-7009-3 - 190 mm - Ø 5 mm
 SSQ-7009-4 - 190 mm - Ø 6 mm
 SSQ-7009-5 - 190 mm - Ø 7 mm
 SSQ-7009-6 - 190 mm - Ø 8 mm
 SSQ-7009-7 - 190 mm - Ø 9 mm
 SSQ-7009-8 - 190 mm - Ø 10 mm
 SSQ-7009-9 - 190 mm - Ø 11 mm

SSQ-7010-1 - 300 mm - Ø 1 mm
 SSQ-7010-2 - 300 mm - Ø 2 mm
 SSQ-7010-3 - 300 mm - Ø 3 mm
 SSQ-7010-4 - 300 mm - Ø 4 mm
 SSQ-7010-5 - 300 mm - Ø 5 mm
 SSQ-7010-6 - 300 mm - Ø 6 mm
 SSQ-7010-7 - 300 mm - Ø 7 mm
 SSQ-7010-8 - 300 mm - Ø 8 mm
 SSQ-7010-9 - 300 mm - Ø 9 mm
 SSQ-7010-10 - 300 mm - Ø 10 mm
 SSQ-7010-11 - 300 mm - Ø 11 mm
 SSQ-7010-12 - 300 mm - Ø 12 mm
 SSQ-7010-13 - 300 mm - Ø 13 mm

SSQ-7009
Set completo di 9 pezzi
con custodia

SSQ-7010
Set completo di
13 pezzi



BAKES
SSQ-7009

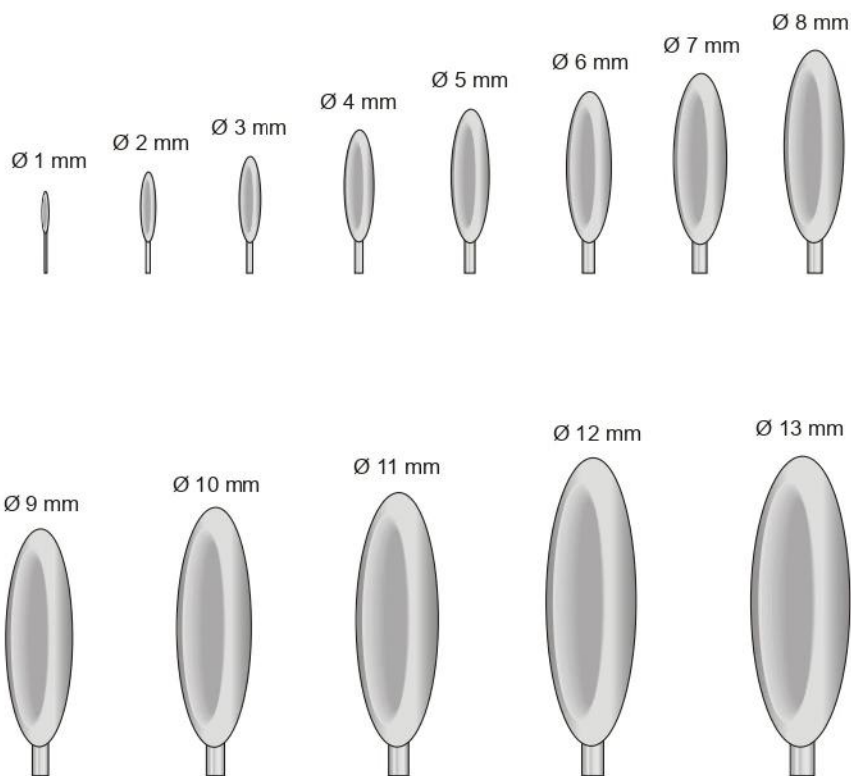



DITTEL
SSQ-7011
220 mm

Charr.

SSQ-7011-1	8
SSQ-7011-2	9
SSQ-7011-3	10
SSQ-7011-4	11
SSQ-7011-5	12
SSQ-7011-6	14
SSQ-7011-7	16
SSQ-7011-8	18
SSQ-7011-9	20
SSQ-7011-10	22
SSQ-7011-11	24
SSQ-7011-12	25
SSQ-7011-13	26
SSQ-7011-14	27
SSQ-7011-15	28
SSQ-7011-16	29
SSQ-7011-17	30

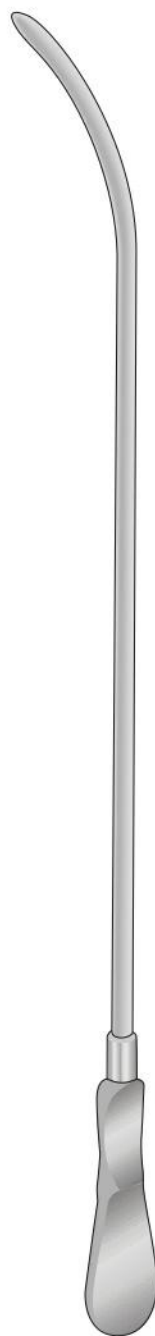

DITTEL
SSQ-7012
345 mm

Charr.

SSQ-7012-1	8
SSQ-7012-2	9
SSQ-7012-3	10
SSQ-7012-4	11
SSQ-7012-5	12
SSQ-7012-6	13
SSQ-7012-7	14
SSQ-7012-8	15
SSQ-7012-9	16
SSQ-7012-10	17
SSQ-7012-11	18
SSQ-7012-12	19
SSQ-7012-13	20
SSQ-7012-14	21
SSQ-7012-15	22
SSQ-7012-16	23
SSQ-7012-17	24
SSQ-7012-18	25
SSQ-7012-19	26
SSQ-7012-20	27
SSQ-7012-21	28
SSQ-7012-22	29
SSQ-7012-23	30

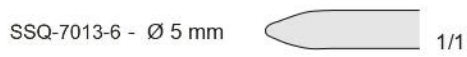

SSQ-7013
190 mm

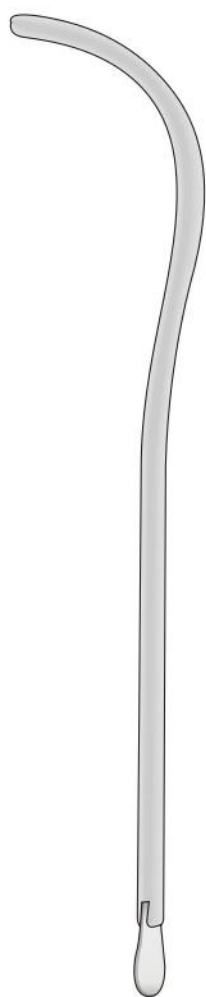

GUYON
SSQ-7014
255 mm

	Ben.	Charr.
SSQ-7014-1	24	12
SSQ-7014-2	26	13
SSQ-7014-3	28	14
SSQ-7014-4	30	15
SSQ-7014-5	32	16
SSQ-7014-6	34	17
SSQ-7014-7	36	18
SSQ-7014-8	38	19
SSQ-7014-9	40	20
SSQ-7014-10	42	21
SSQ-7014-11	44	22
SSQ-7014-12	46	23
SSQ-7014-13	48	24
SSQ-7014-14	50	25
SSQ-7014-15	52	26
SSQ-7014-16	54	27
SSQ-7014-17	56	28
SSQ-7014-18	58	29
SSQ-7014-19	60	30

Sonde per dotto biliare, Elastiche
Gall Stone Probes, Elastic
Gallensteinsonden, Federnd
Explorateurs pour calculs biliaires, Élastiques
Exploradores para cálculos biliaires, Elásticos

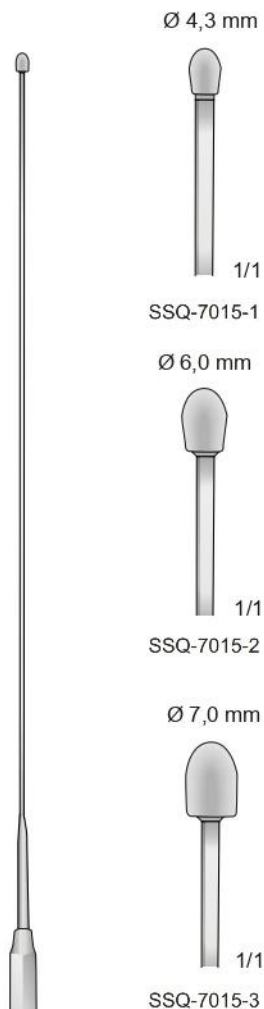

DESJARDINS
SSQ-7015
280 mm

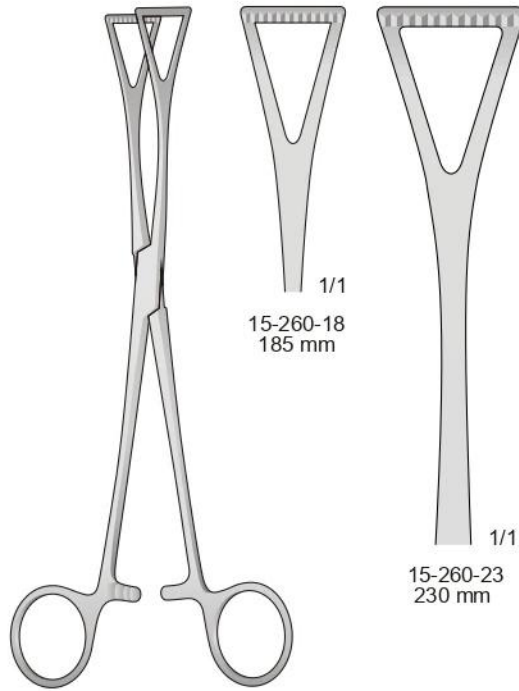

DUVAL
SSQ-7016

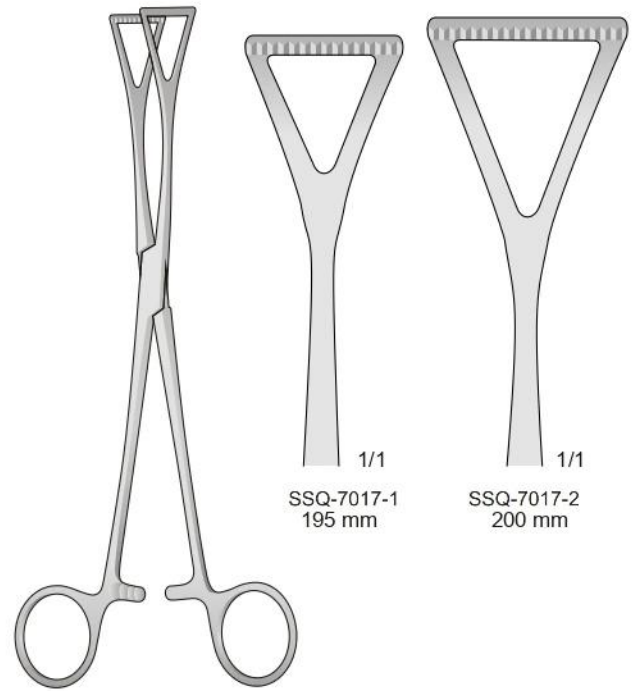

DUVAL-COLLIN
SSQ-7017

Pinze per peduncoli renali - Kidney pedicle clamp forceps - Nierenstielklemmen
Pincas-clamps pour pédicules rénaux - Pinzas-clamps para pedúnculos renales

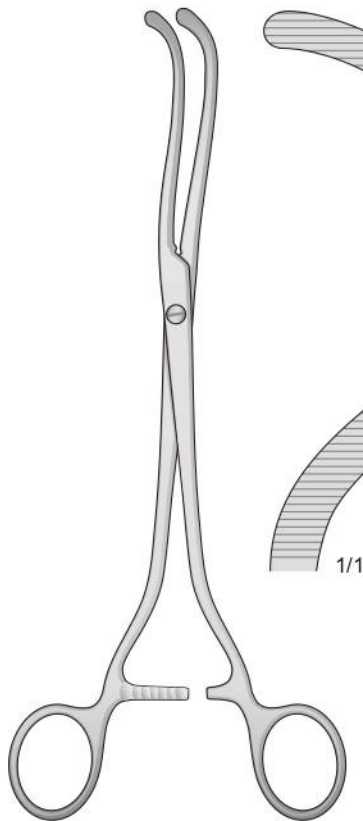

BRAUN
SSQ-7018
245 mm

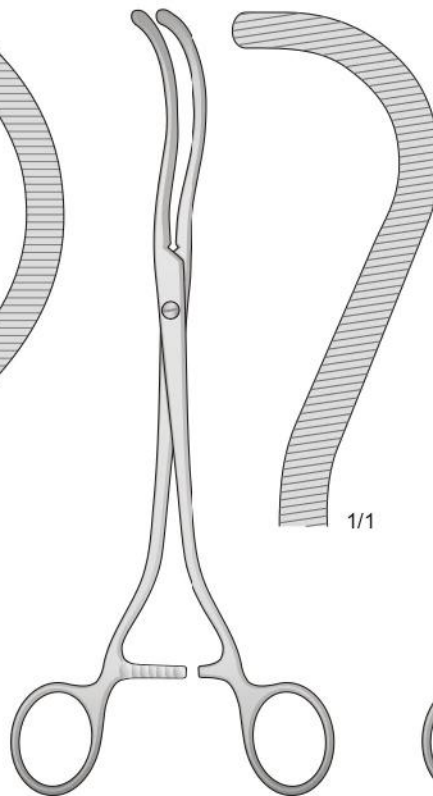

GUYON
15-290-23
235 mm

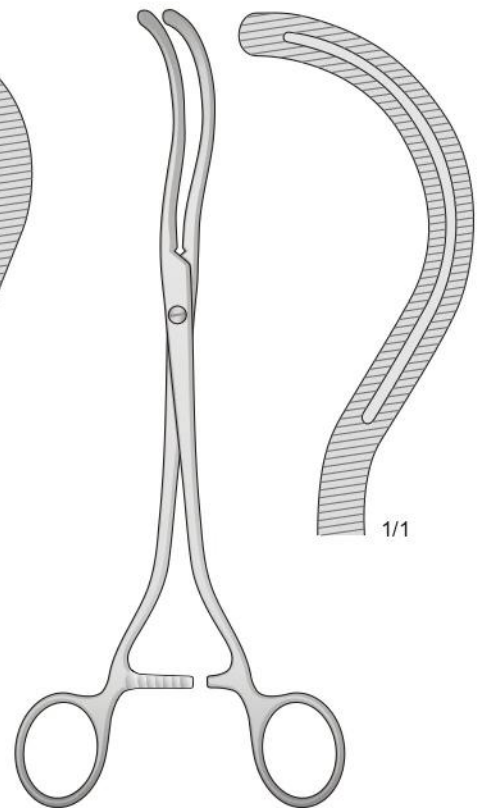

STILLE
SSQ-7020
240 mm

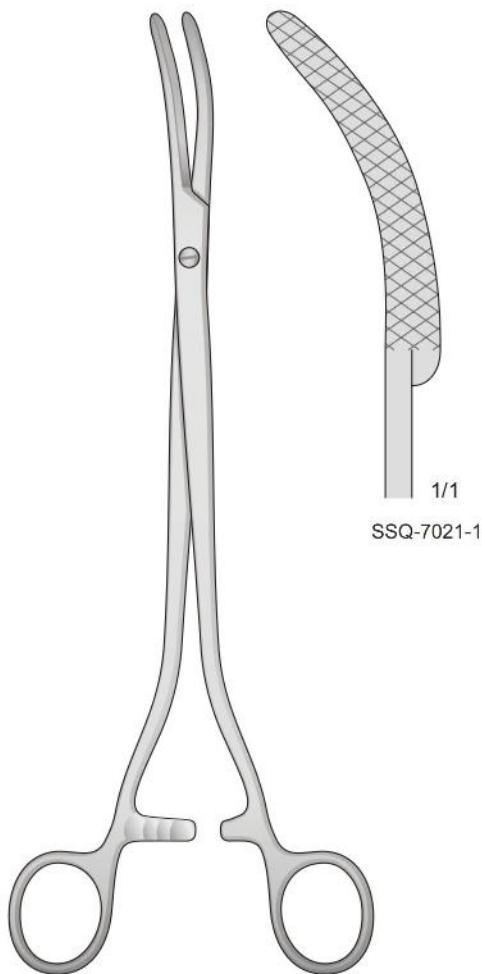

WERTHEIM
SSQ-7021
260 mm

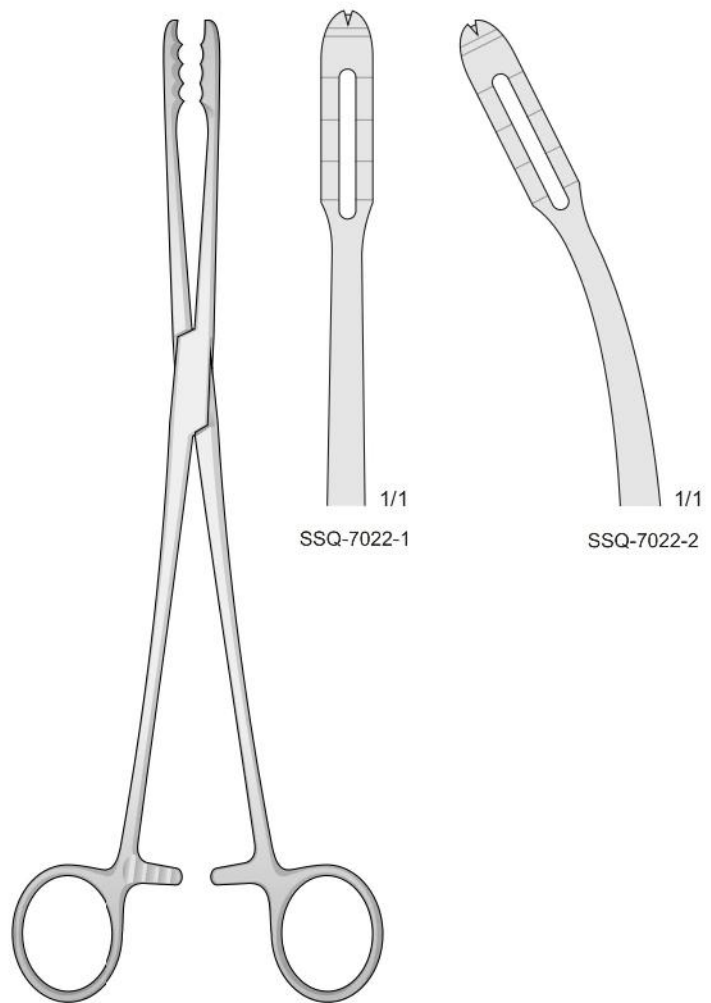

SSQ-7022
265 mm

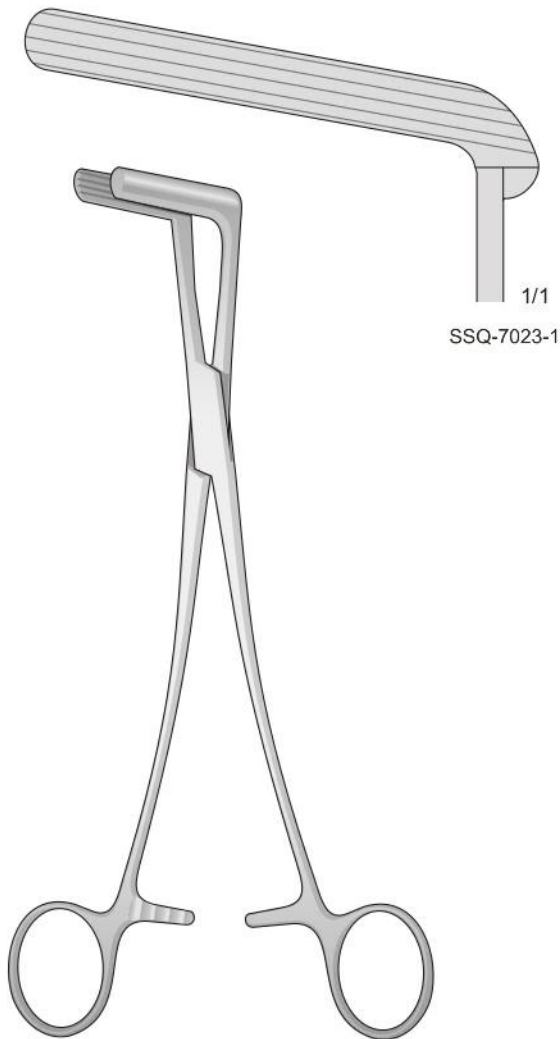

SSQ-7023-1

WERTHEIM
SSQ-7023
235 mm

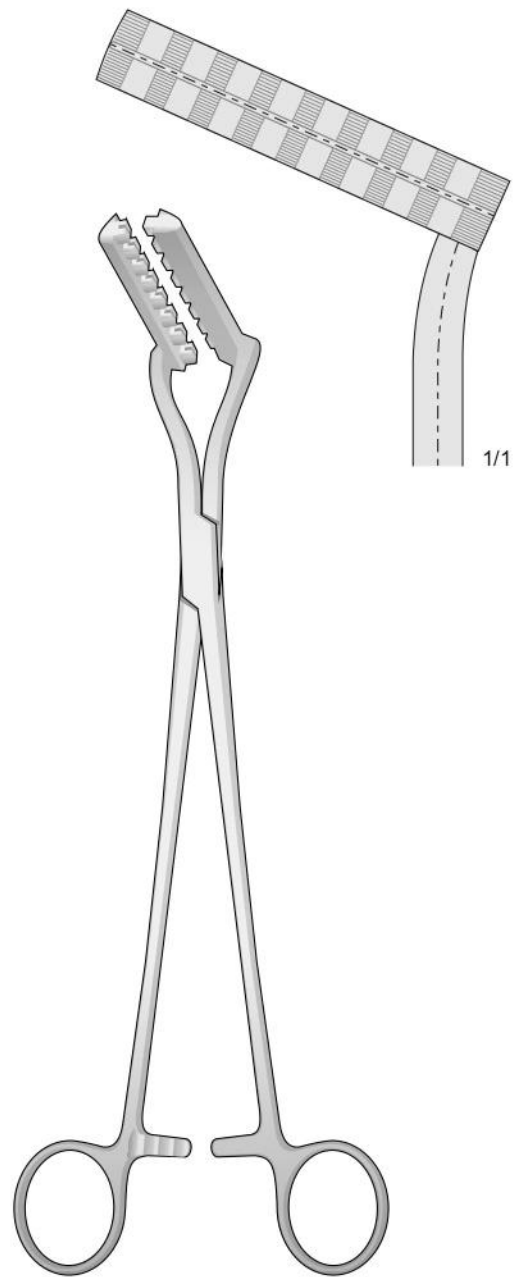

SSQ-7024
280 mm

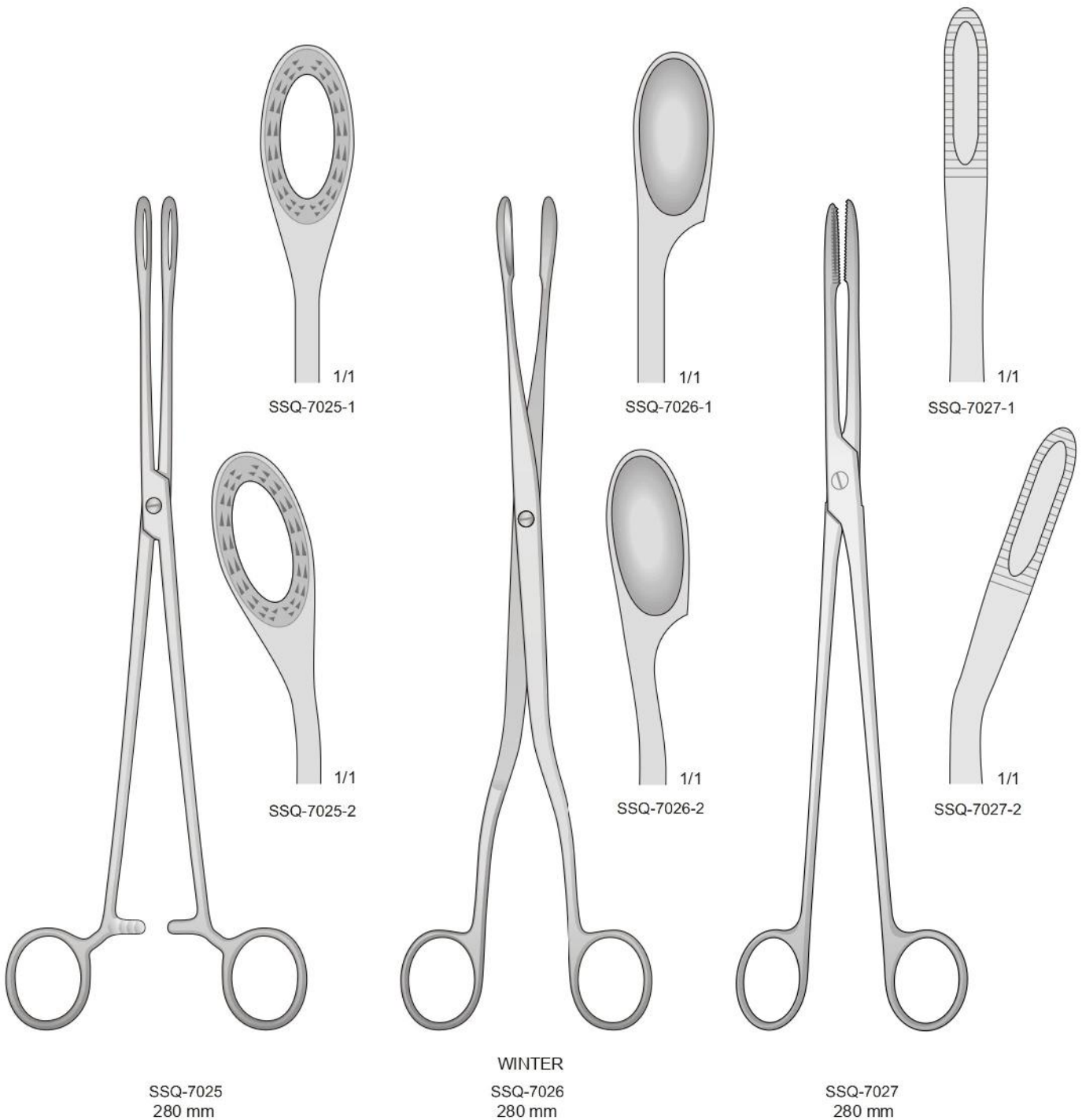

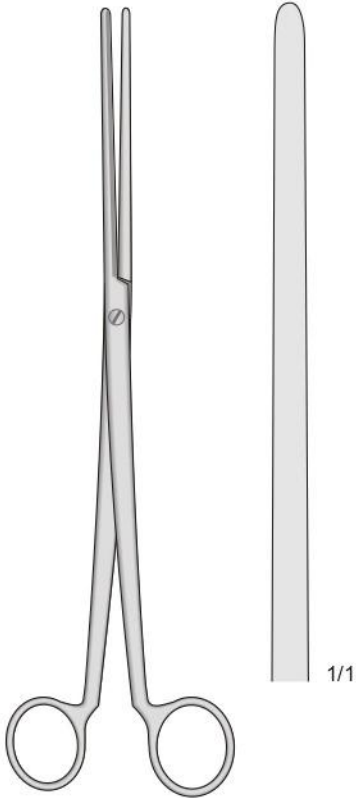

COLLIN
SSQ-7028
260 mm

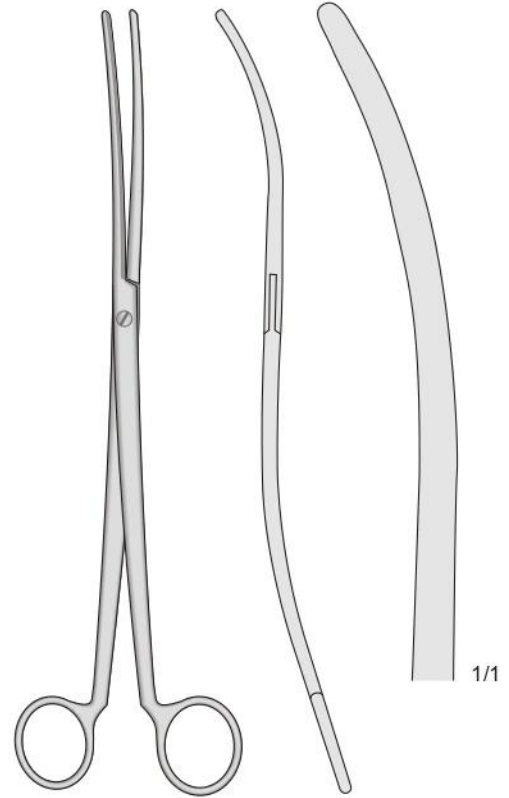

COLLIN
SSQ-7029
260 mm

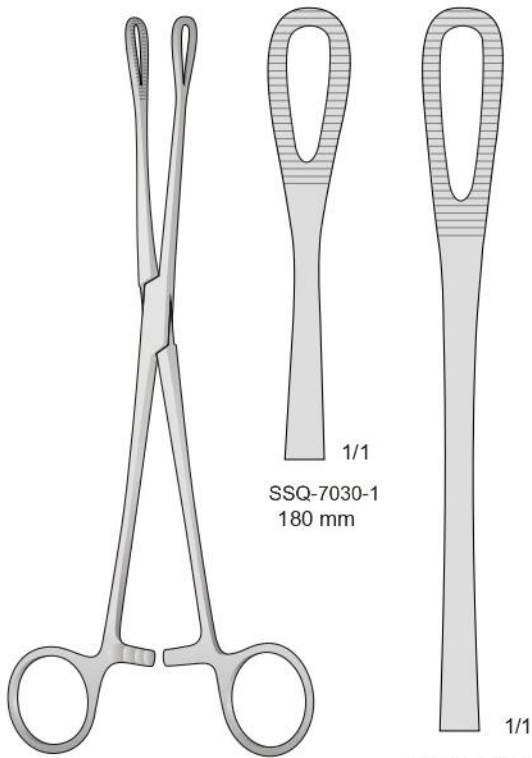

RAMPLEY
SSQ-7030

SSQ-7030-1
180 mm

SSQ-7030-2
245 mm

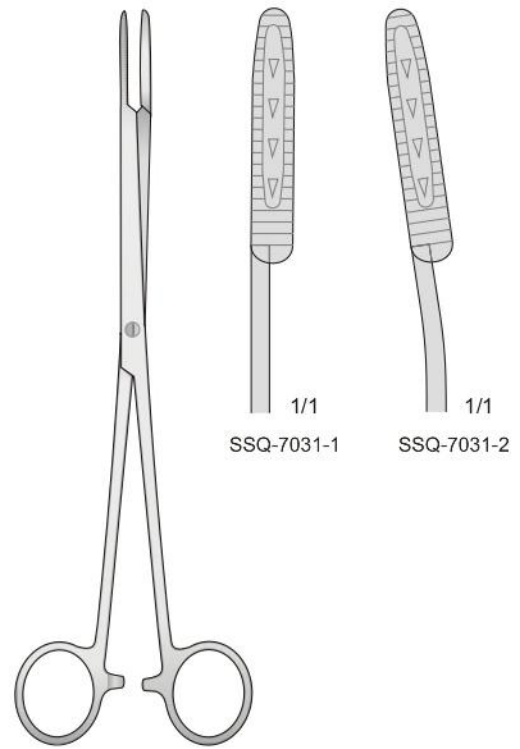

MAIER
SSQ-7031
245 mm

SSQ-7031-1

SSQ-7031-2



SSQ-7032
Set 2 pezzi - Set 2 pieces
Set 2 stück - Set 2 pièces
Set 2 piezas
70 x 40 mm
70 x 33 mm

KALLMORGEN
SSQ-7032-1 - 70 x 40 mm
170 mm

SSQ-7032-2 - 70 x 33 mm
170 mm

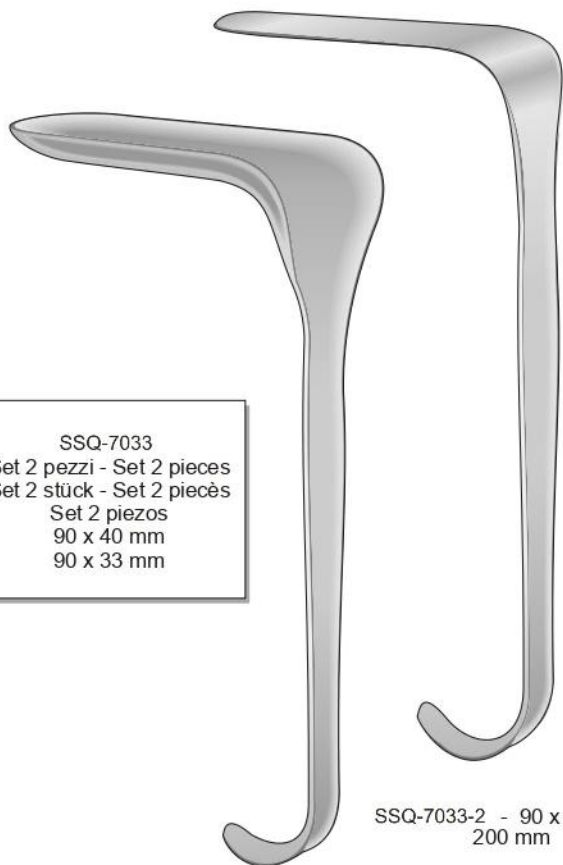

SSQ-7033
Set 2 pezzi - Set 2 pieces
Set 2 stück - Set 2 pièces
Set 2 piezas
90 x 40 mm
90 x 33 mm

KALLMORGEN
SSQ-7033-1 - 90 x 40 mm
200 mm

SSQ-7033-2 - 90 x 33 mm
200 mm

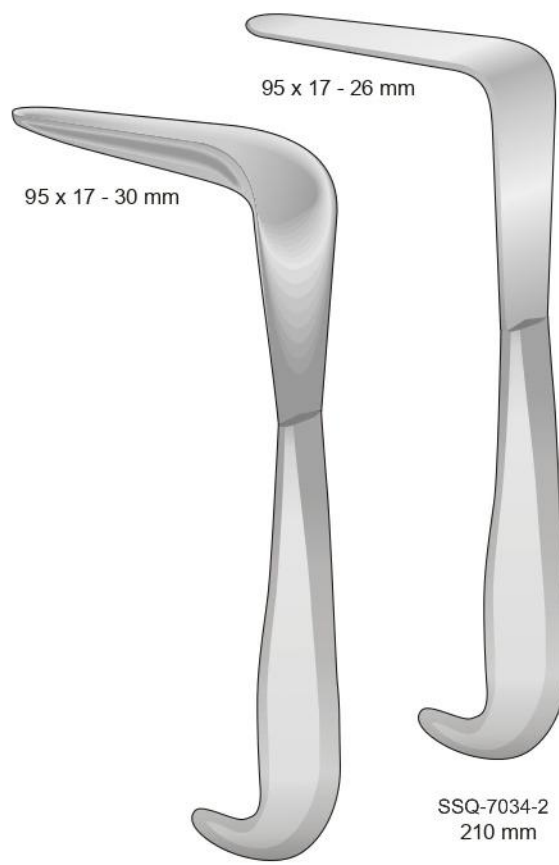

MATHIEU
SSQ-7034-1
210 mm

SSQ-7034-2
210 mm

95 x 17 - 30 mm

95 x 17 - 26 mm

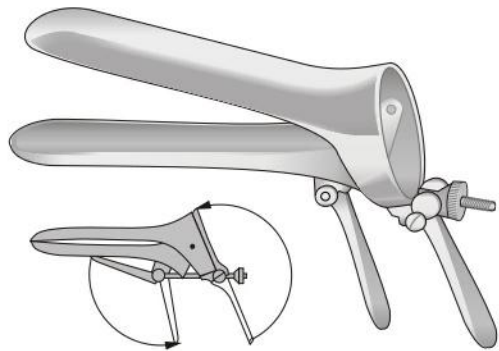

CUSCO
 SSQ-7035-1 Fig. 0 77x17 mm
 SSQ-7035-2 Fig. 1 75x33 mm
 SSQ-7035-3 Fig. 2 86x36 mm
 SSQ-7035-4 Fig. 3 97x36 mm

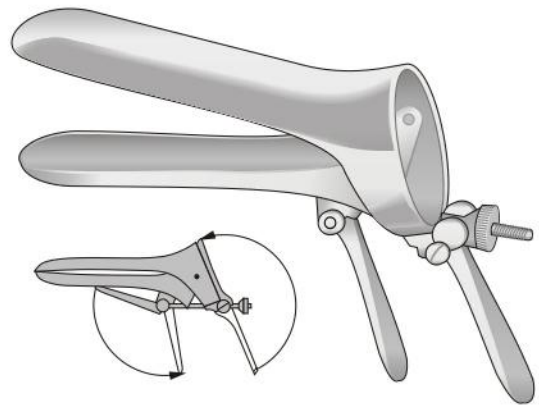

**CUSCO
SCHWEIZER MODELL**
 SSQ-7036-1 Fig.1 90x23 mm
 SSQ-7036-2 Fig.2 100x24 mm
 SSQ-7036-3 Fig.3 105x27 mm

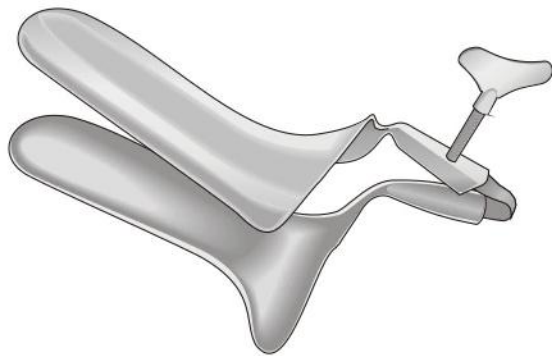

COLLIN-STANDARD
 SSQ-7037-1 Fig. 1 90x29 mm
 SSQ-7037-2 Fig. 2 95x35 mm
 SSQ-7037-3 Fig. 3 110x40 mm

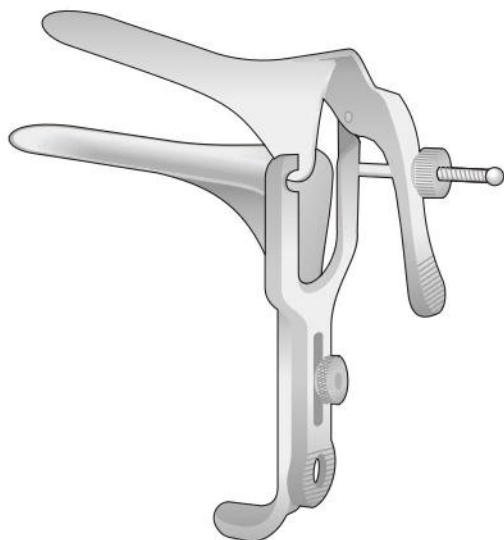

GRAVE
 SSQ-7038-1 75x20 mm
 SSQ-7038-2 95x30 mm
 SSQ-7038-3 105x33 mm

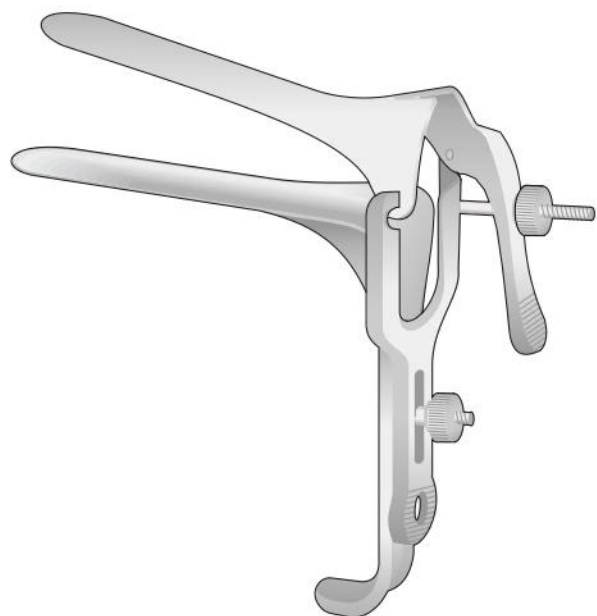

PEDERSON
 SSQ-7039-1 700x22 mm
 SSQ-7039-2 720x25 mm

Speculum
Spekula
Specula
Spéculums
Espéculos



KRISTELLER
Fig. 1 SSQ-7040-1 - 70 x 27 mm
Fig. 2 SSQ-7040-2 - 75 x 30 mm
Fig. 3 SSQ-7040-3 - 90 x 36 mm

Valva
Halter
Retractors
Valves
Valvas

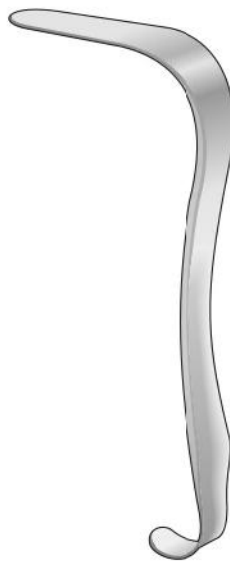

KRISTELLER
Fig. 1 SSQ-7040-4 - 75 x 23 mm
Fig. 2 SSQ-7040-5 - 80 x 26 mm
Fig. 3 SSQ-7040-6 - 95 x 32 mm

Speculum + Valva
Specula + Retractor
Spekula + Halter
Spéculum + Valve
Espéculo + Valva



Fig. 1 SSQ-7041-1
Fig. 2 SSQ-7041-2
Fig. 3 SSQ-7041-3

Speculum
Spekula
Specula
Spéculums
Espéculos



KRISTELLER
Fig. 00 SSQ-7043-1 - 110 x 18 mm
Fig. 0 SSQ-7043-2 - 110 x 21 mm
Fig. 1 SSQ-7043-3 - 110 x 27 mm
Fig. 2 SSQ-7043-4 - 110 x 30 mm
Fig. 3 SSQ-7043-5 - 110 x 36 mm

Valva
Halter
Retractors
Valves
Valvas



KRISTELLER
Fig. 00 SSQ-7043-6 - 115 x 14 mm
Fig. 0 SSQ-7043-7 - 115 x 17 mm
Fig. 1 SSQ-7043-8 - 115 x 23 mm
Fig. 2 SSQ-7043-9 - 115 x 26 mm
Fig. 3 SSQ-7043-10 - 115 x 32 mm

Speculum + Valva
Specula + Retractor
Spekula + Halter
Spéculum + Valve
Espéculo + Valva



Fig. 00 SSQ-7044-1
Fig. 0 SSQ-7044-2
Fig. 1 SSQ-7044-3
Fig. 2 SSQ-7044-4
Fig. 3 SSQ-7044-5

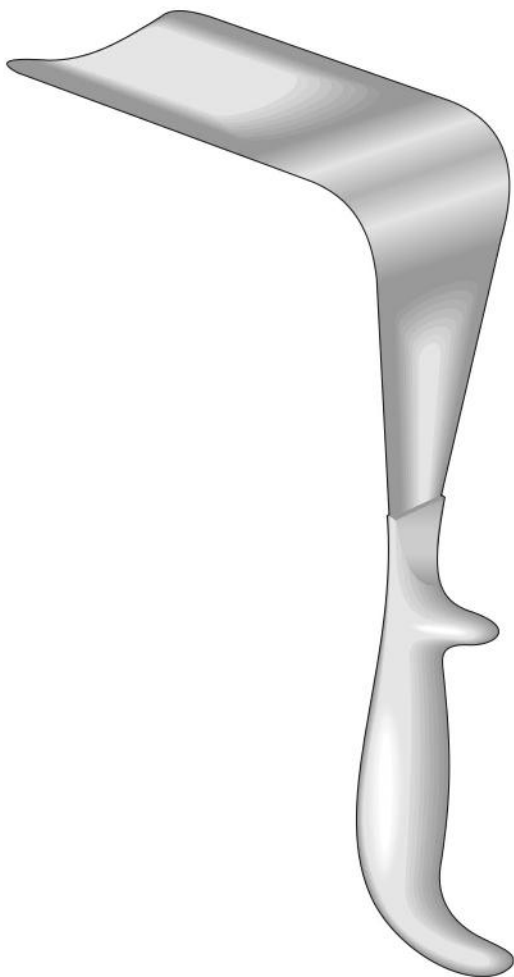

DOYEN
SSQ-7045
240 mm

- Fig. 1 SSQ-7045-1 - 60 x 35 mm
- Fig. 2 SSQ-7045-2 - 90 x 35 mm
- Fig. 3 SSQ-7045-3 - 120 x 35 mm

- Fig. 1 SSQ-7045-4 - 60 x 45 mm
- Fig. 2 SSQ-7045-5 - 90 x 45 mm
- Fig. 3 SSQ-7045-6 - 120 x 45 mm
- Fig. 4 SSQ-7045-7 - 160 x 45 mm

- Fig. 1 SSQ-7045-8 - 60 x 60 mm
- Fig. 2 SSQ-7045-9 - 90 x 60 mm
- Fig. 3 SSQ-7045-10 - 120 x 60 mm
- Fig. 4 SSQ-7045-11 - 160 x 60 mm



LANDAU
SSQ-7046
290 mm

- SSQ-7046-1 - 100 x 28 mm
- SSQ-7046-2 - 100 x 38 mm



BREISKY

- SSQ-7047-1 - 100 x 20 mm
- SSQ-7047-2 - 100 x 25 mm
- SSQ-7047-3 - 100 x 30 mm
- SSQ-7047-4 - 100 x 35 mm
- SSQ-7047-5 - 100 x 40 mm
- 290 mm

BREISKY

- SSQ-7048-1 - 130 x 20 mm
- SSQ-7048-2 - 130 x 25 mm
- SSQ-7048-3 - 130 x 30 mm
- SSQ-7048-4 - 130 x 35 mm
- SSQ-7048-5 - 130 x 40 mm
- 320 mm

BREISKY

- SSQ-7049 - 160 x 40 mm
- 350 mm

BREISKY

- SSQ-7050 - 180 x 40 mm
- 370 mm

Hegar Dilatatori - Hegar Dilatators - Hegar Dilatatoren - Hegar Dilateur - Hegar Dilatadores

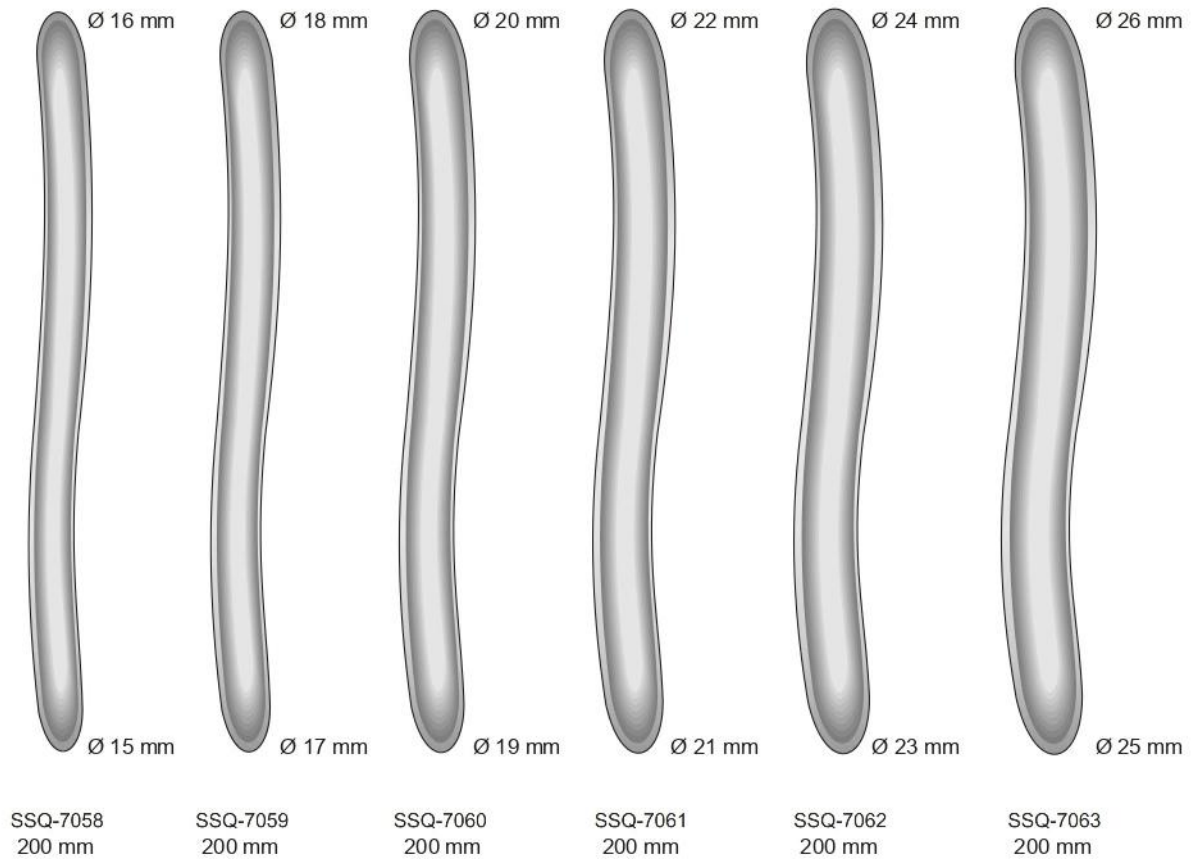
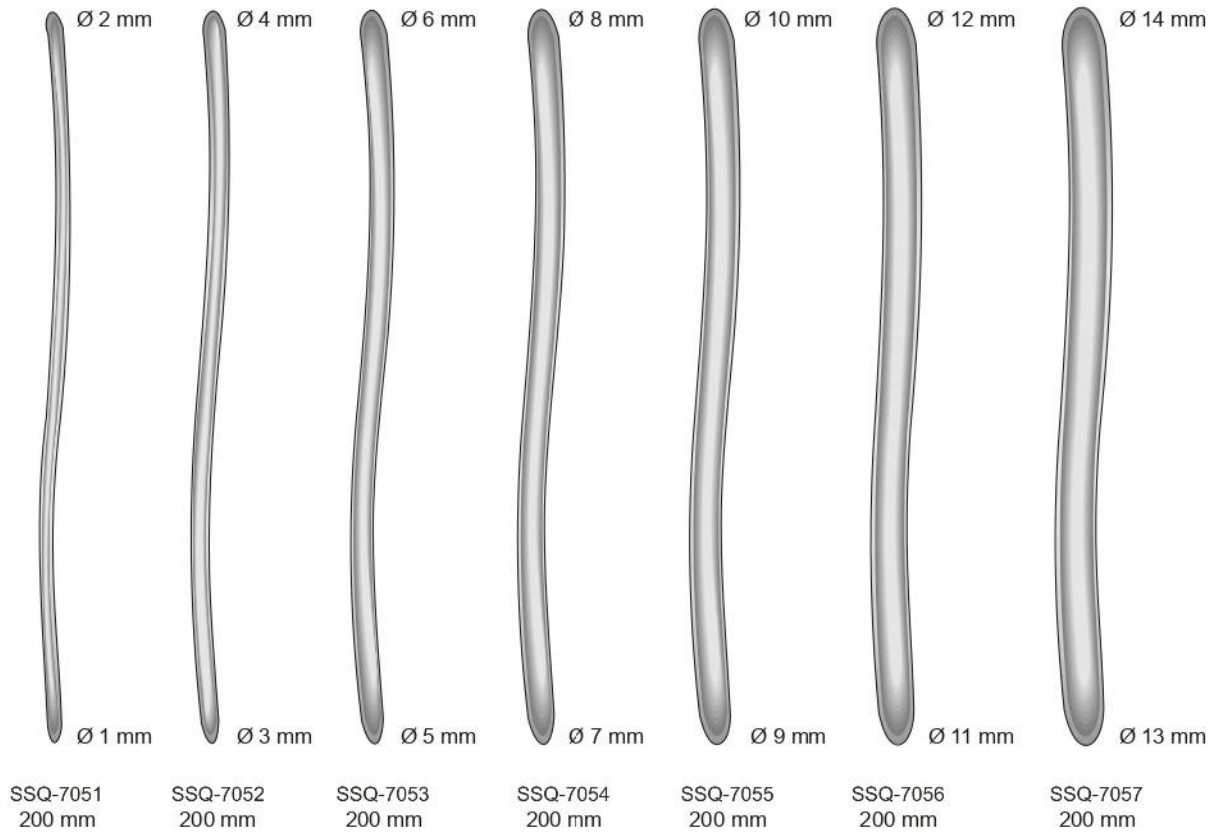

Set completo dilatatori 8 pezzi
Set complete with 8 pieces
Satz-Dilatator, komplett, 8 Stück
Jeu complet avec 8 pieces
Juego completo con 8 piezas

Pratt Dilatatori
Pratt Dilatators
Pratt Dilatatoren
Pratt Dilatateur
Pratt Dilatadores

La misura è in French
Breite in French

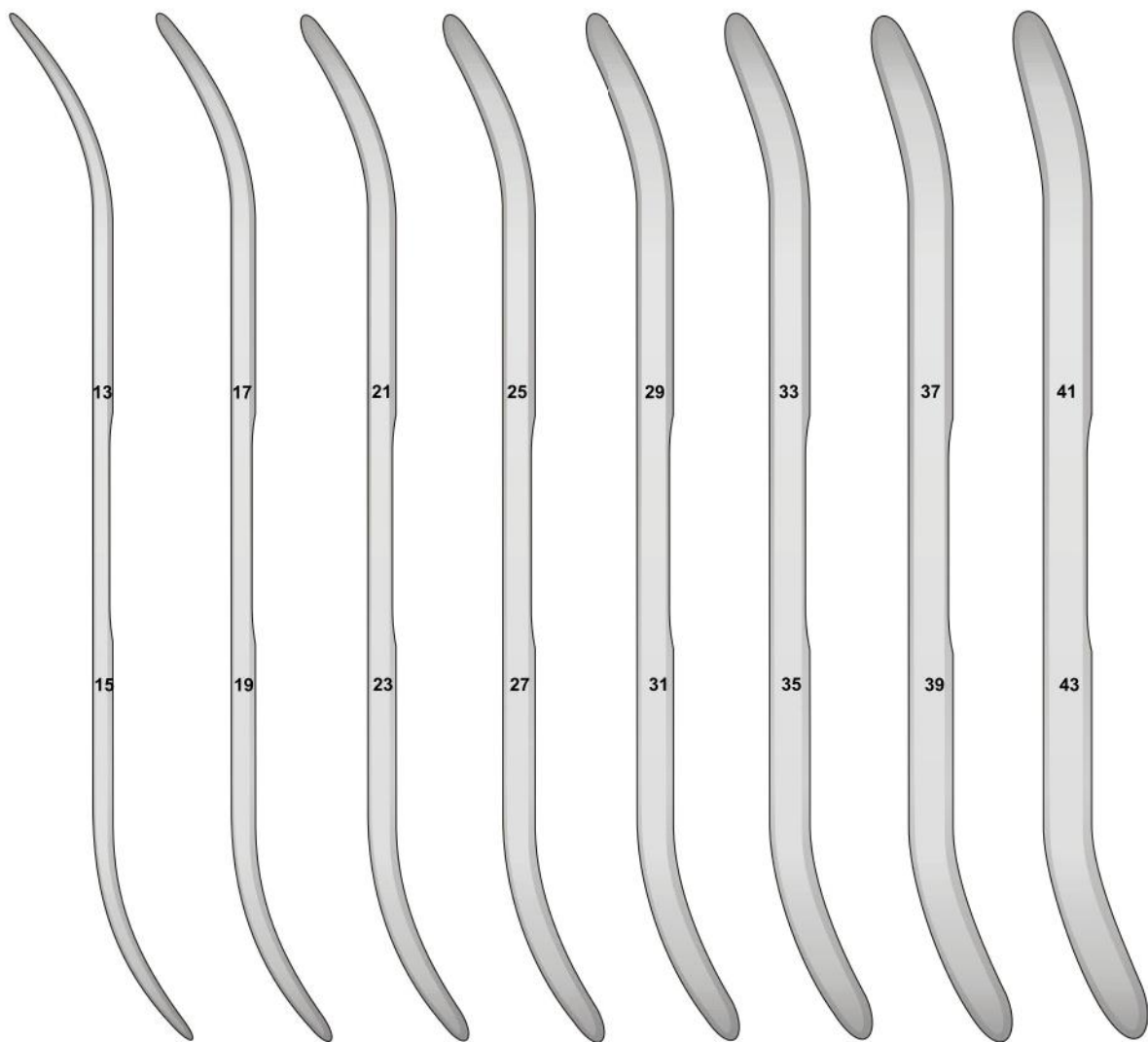

SSQ-7064	SSQ-7065	SSQ-7066	SSQ-7067	SSQ-7068	SSQ-7069	SSQ-7070	SSQ-7071
260 mm	260 mm	260 mm	260 mm	260 mm	260 mm	260 mm	260 mm



SSQ-7072-01	1 mm	SSQ-7072-14	14 mm	SSQ-7072-29	1½ mm	SSQ-7072-40	14½ mm
SSQ-7072-02	2 mm	SSQ-7072-15	15 mm	SSQ-7072-30	2½ mm	SSQ-7072-41	15½ mm
SSQ-7072-03	3 mm	SSQ-7072-16	16 mm	SSQ-7072-31	3½ mm	SSQ-7072-42	16½ mm
SSQ-7072-04	4 mm	SSQ-7072-17	17 mm	SSQ-7072-32	4½ mm	SSQ-7072-43	17½ mm
SSQ-7072-05	5 mm	SSQ-7072-18	18 mm	SSQ-7072-33	5½ mm		
SSQ-7072-06	6 mm	SSQ-7072-19	19 mm	SSQ-7072-34	6½ mm		
SSQ-7072-07	7 mm	SSQ-7072-20	20 mm	SSQ-7072-35	7½ mm		
SSQ-7072-08	8 mm	SSQ-7072-21	21 mm	SSQ-7072-36	8½ mm		
SSQ-7072-09	9 mm	SSQ-7072-22	22 mm	SSQ-7072-37	9½ mm		
SSQ-7072-10	10 mm	SSQ-7072-23	23 mm	SSQ-7072-38	10½ mm		
SSQ-7072-11	11 mm	SSQ-7072-24	24 mm	SSQ-7072-39	11½ mm		
SSQ-7072-12	12 mm	SSQ-7072-25	25 mm		12½ mm		
SSQ-7072-13	13 mm	SSQ-7072-26	26 mm		13½ mm		

HEGAR
SSQ-7072
185 mm

Fig. 9/10
Ø 4,5/5,0 mm

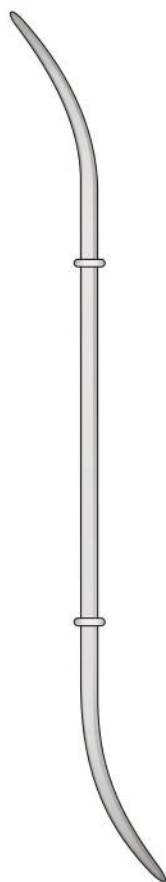

HANK

SSQ-7073-1
260 mm

Fig. 11/12
Ø 5,5/6,0 mm

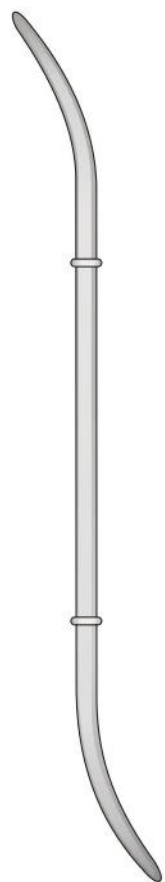

HANK

SSQ-7073-2
260 mm

Fig. 13/14
Ø 6,5/7,0 mm

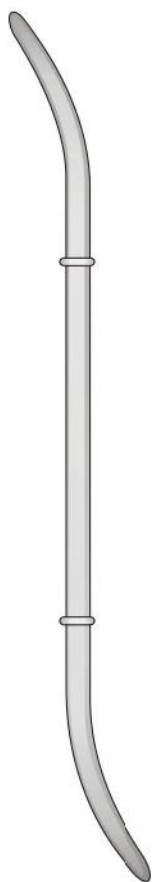

HANK

SSQ-7073-3
260 mm

Fig. 15/16
Ø 7,5/8,0 mm

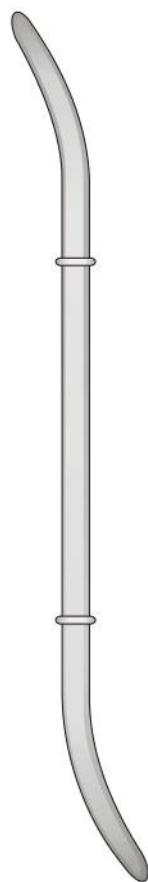

HANK

SSQ-7073-4
260 mm

Fig. 17/18
Ø 8,5/9,0 mm

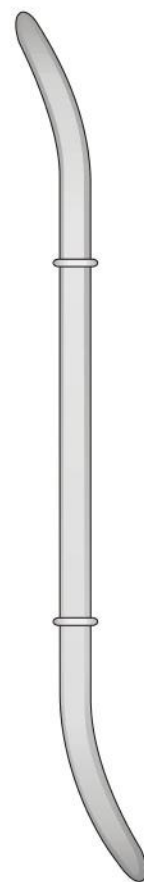

HANK

SSQ-7073-5
260 mm

Fig. 19/20
Ø 9,5/10 mm

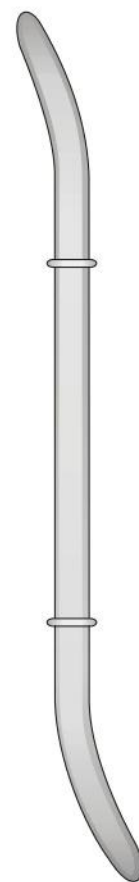

HANK

SSQ-7073-6
260 mm

Graduati in centimetri
Graduated in centimeters
Zentimeterenteilung
Gradué en centimètres
Graduado en centímetros

Malleabile
Malleable
Biegsam
Malléables
Maleables

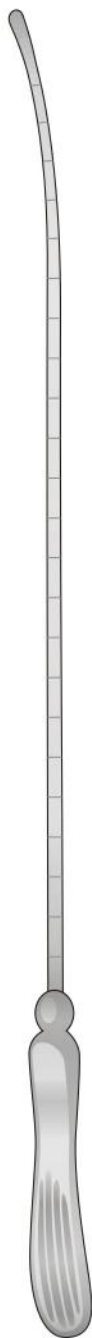

SIMS
SSQ-7074
320 mm

Malleabile
Malleable
Biegsam
Malléables
Maleables

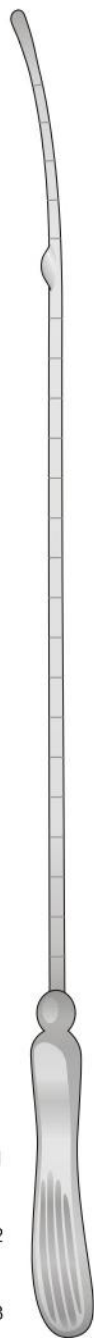

SIMPSON
SSQ-7075 Ø 3mm
320 mm

Rigido
Rigid
Fest
Rigides
Rigidos

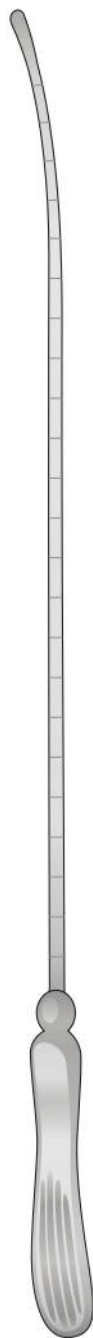

SIMS
SSQ-7076
320 mm

SSQ-7076-1
Ø 3 mm
SSQ-7076-2
Ø 4 mm



VALLEIX
SSQ-7077 Ø 4mm
265 mm



MARTIN
SSQ-7078 Ø 3mm
300 mm

Malleabile
Malleable
Biegsam
Malléables
Maleables



MAYO
SSQ-7079 Ø 5mm
330 mm

Amniotomo per la
vescica amniotica
Amniotome for the
amniotic bladder
Amniotom für die
Amnionblase
Amniotome pour la
vésicule amniotique
Amniotomo para la
vesícula amniótica

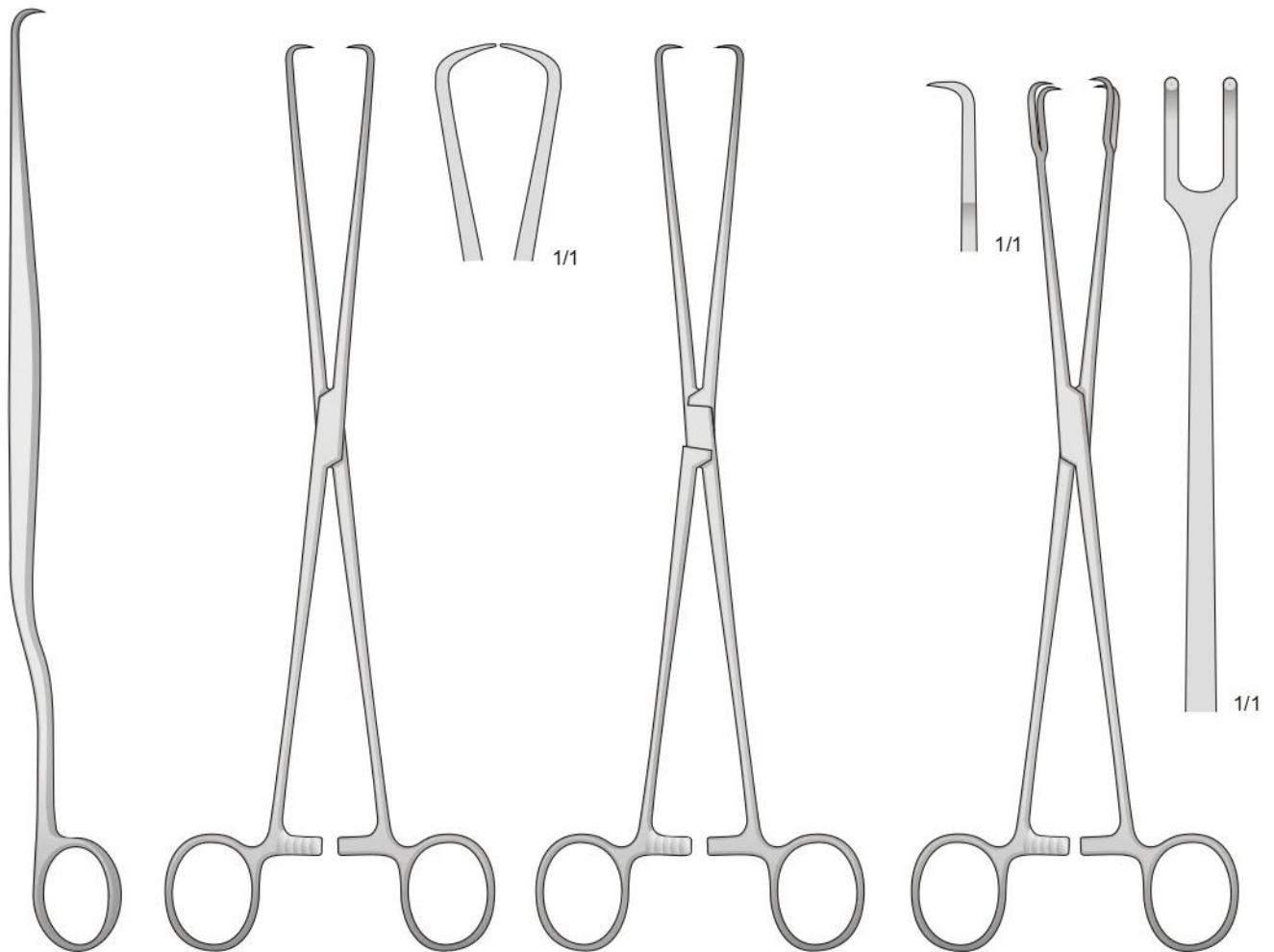

BEACHAM
SSQ-7080
260 mm

BRAUN
SSQ-7081
250 mm

POZZI
SSQ-7082
250 mm

SCHROEDER
SSQ-7083
240 mm

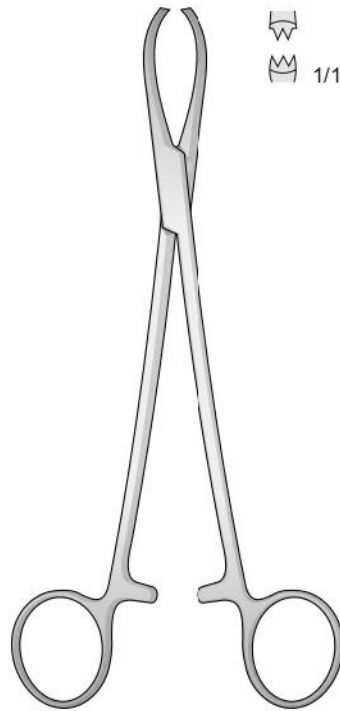

LITTLEWOOD
SSQ-7084
185 mm

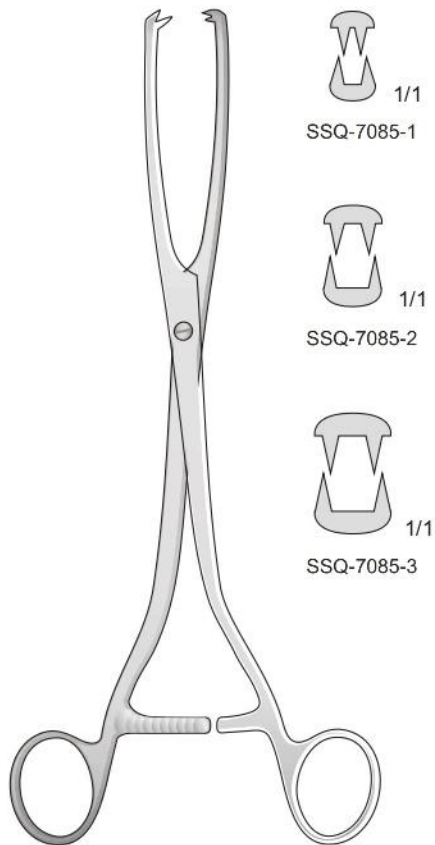

MUSEUX
SSQ-7085
240 mm

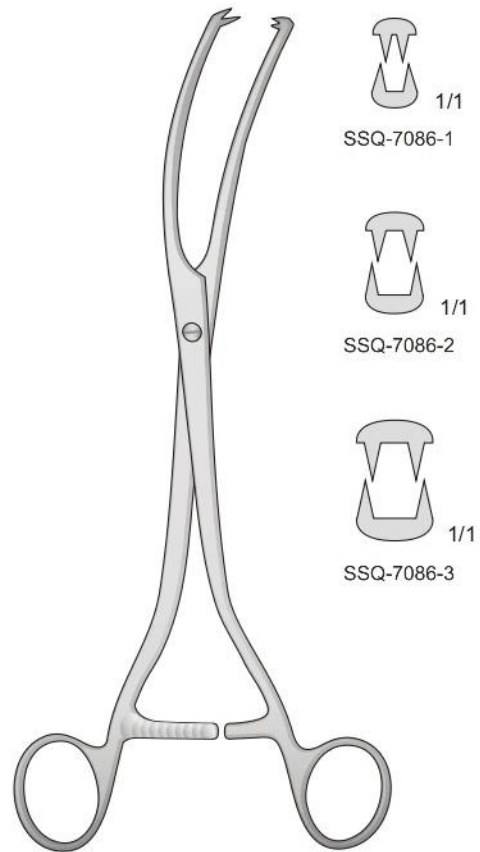

MUSEUX
SSQ-7086
240 mm

Pinzette per tube

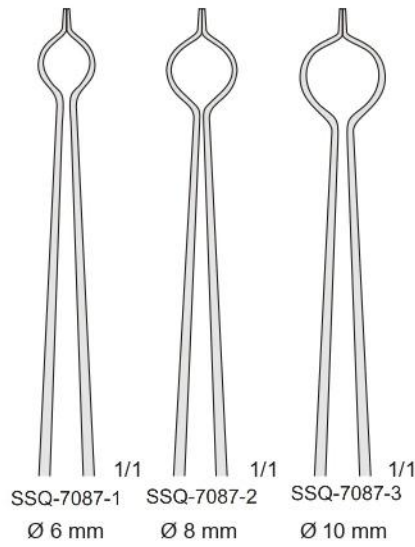

NEUBÜSER
SSQ-7087
200 mm

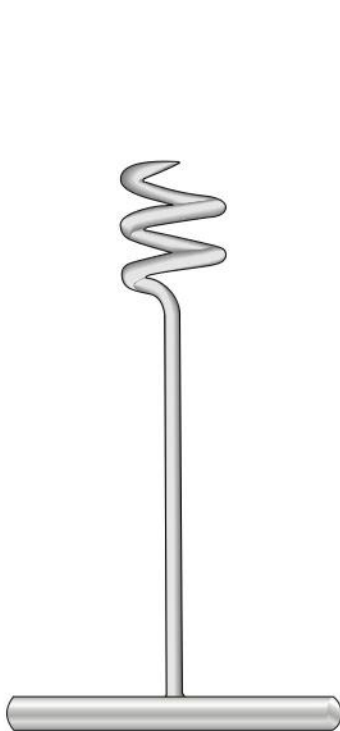

DOYEN
SSQ-7088
150 mm

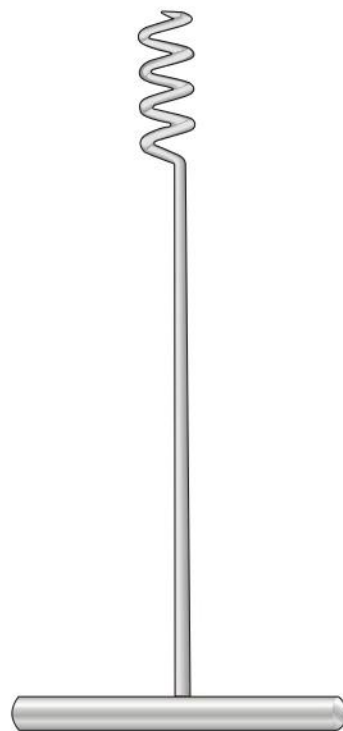

DOYEN
SSQ-7089
170 mm

Curette per biopsia endouterina
Endometrial Biopsy curette
Endometrium-Strichkürette
Curette pour biopsie intra-utérines
Cureta para biopsia endo-uterina

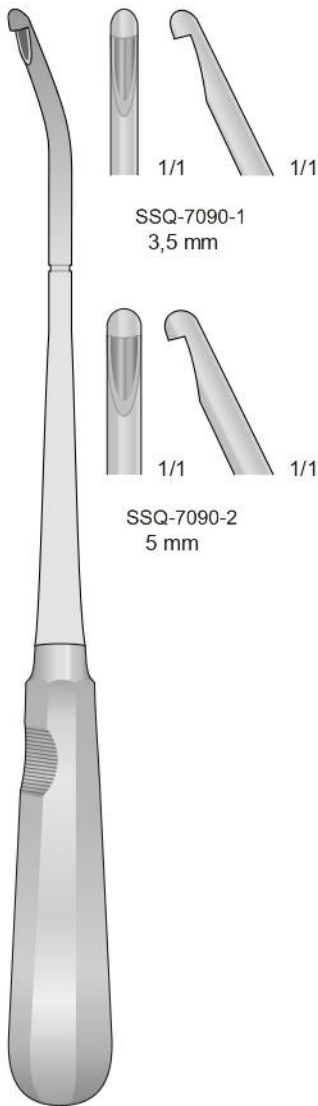

MÜNCHEN
SSQ-7090
270 mm

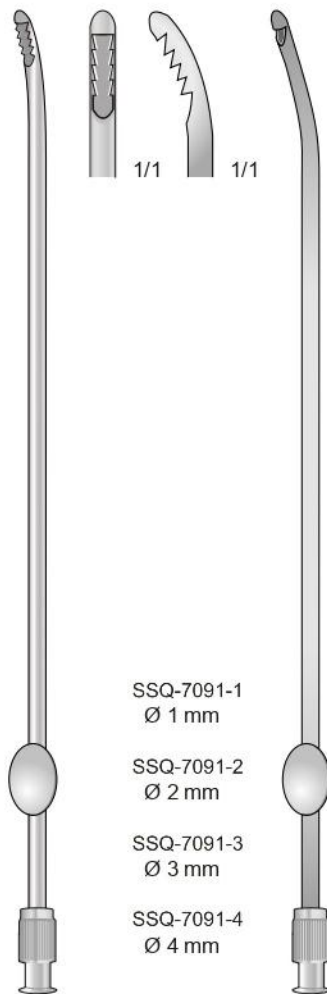

NOVAK
SSQ-7091
230 mm

RANDALL
SSQ-7092
230 mm

Curette per biopsia endocervicale
Endocervical Biopsy Curettes
Endocervix-Biopsieküretten

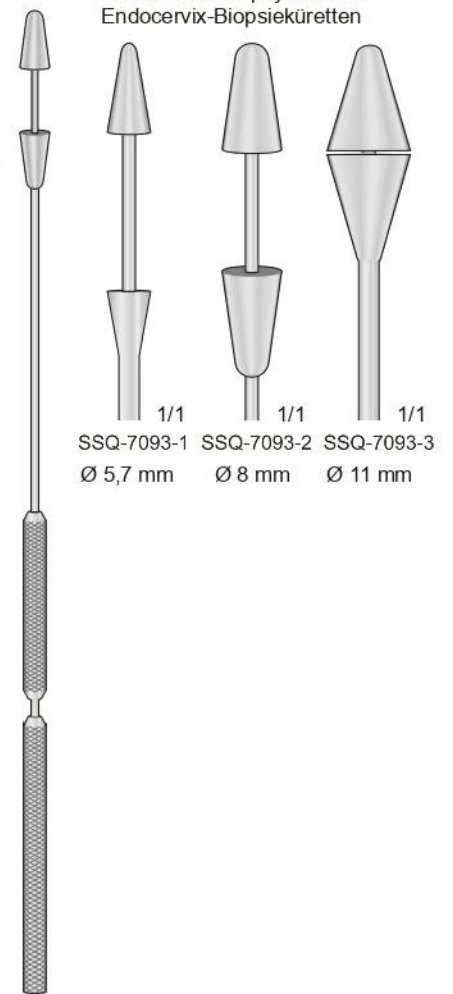

GUSBERG
SSQ-7093
240 mm

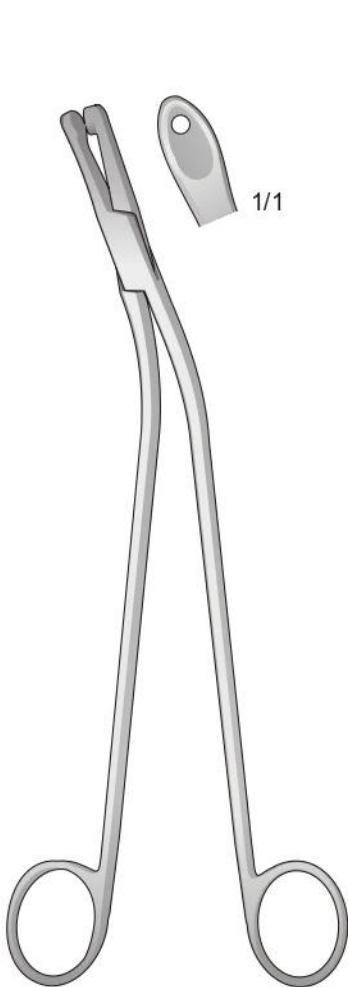

GELLHORN
SSQ-7094
230 mm

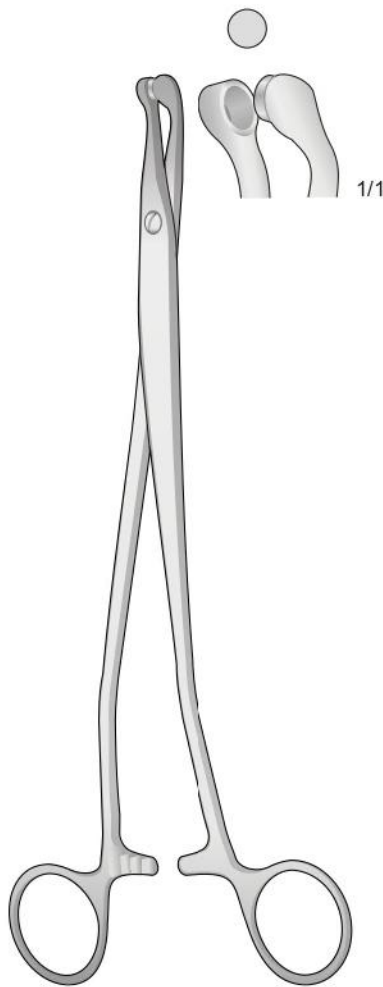

THOMS-GAYLOR
SSQ-7095
240 mm

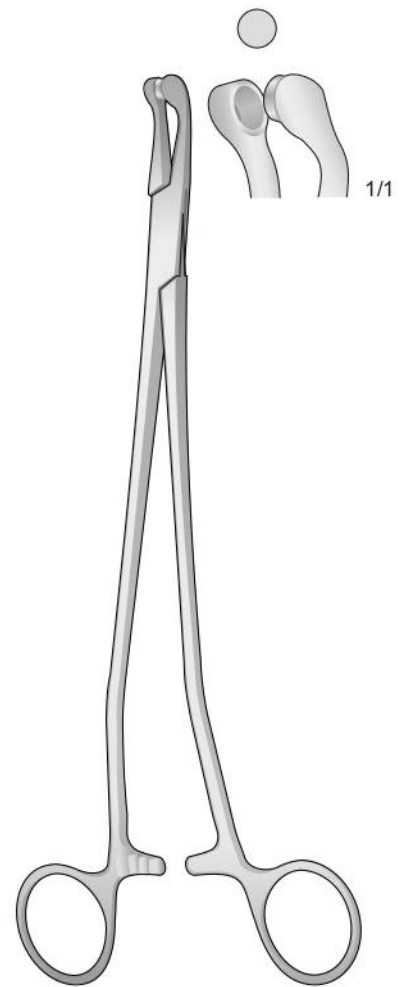

THOMS-GAYLOR
SSQ-7095-1 220 mm
SSQ-7095-2 240 mm

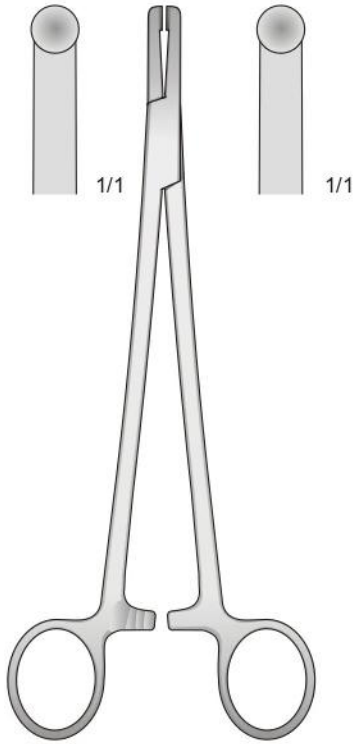

SSQ-7096
205 mm

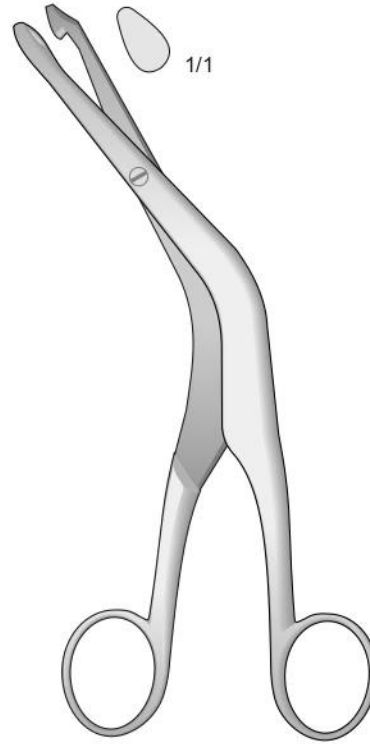

FAURE
SSQ-7097
210 mm

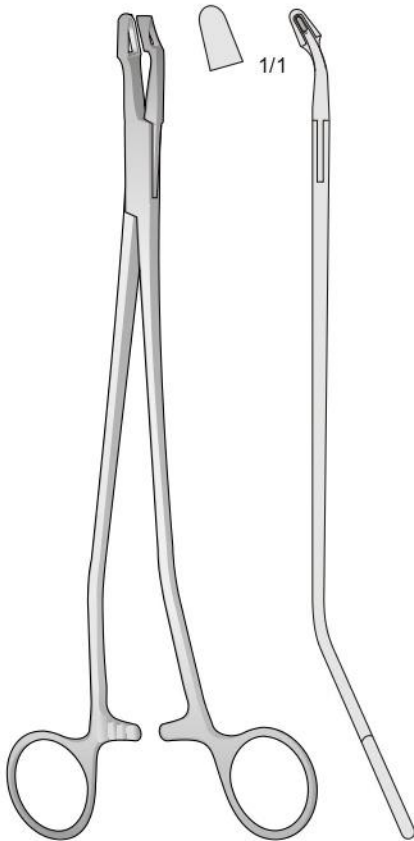

VAN DOREN
SSQ-7098
250 mm

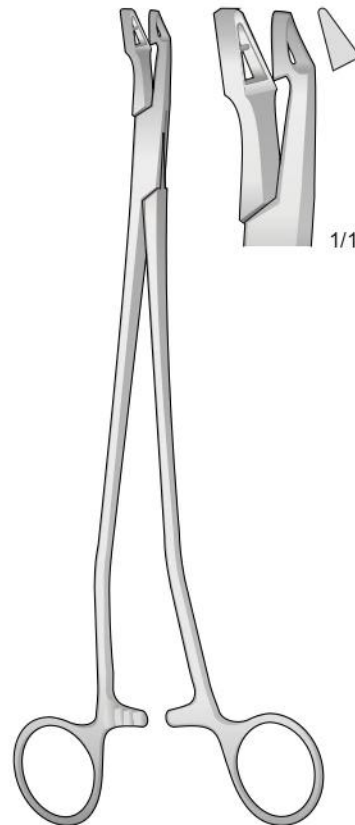

VAN DOREN
SSQ-7099
240 mm

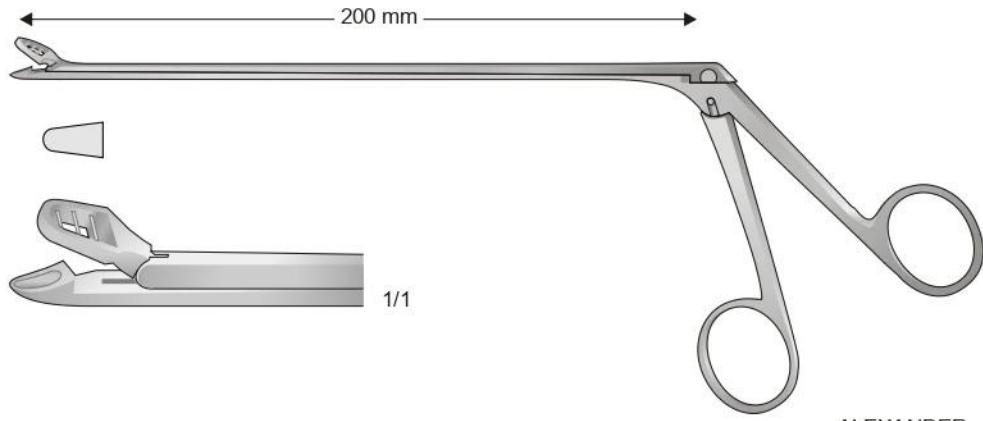

ALEXANDER
SSQ-7100

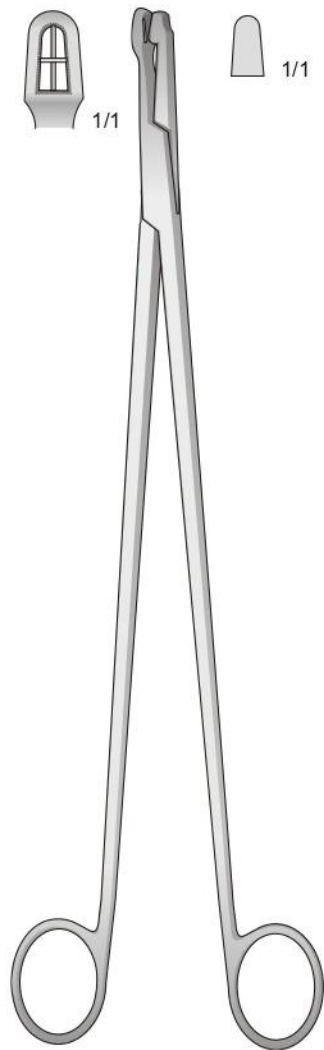

SCHUBERT
SSQ-7101-1 210 mm
SSQ-7101-2 290 mm

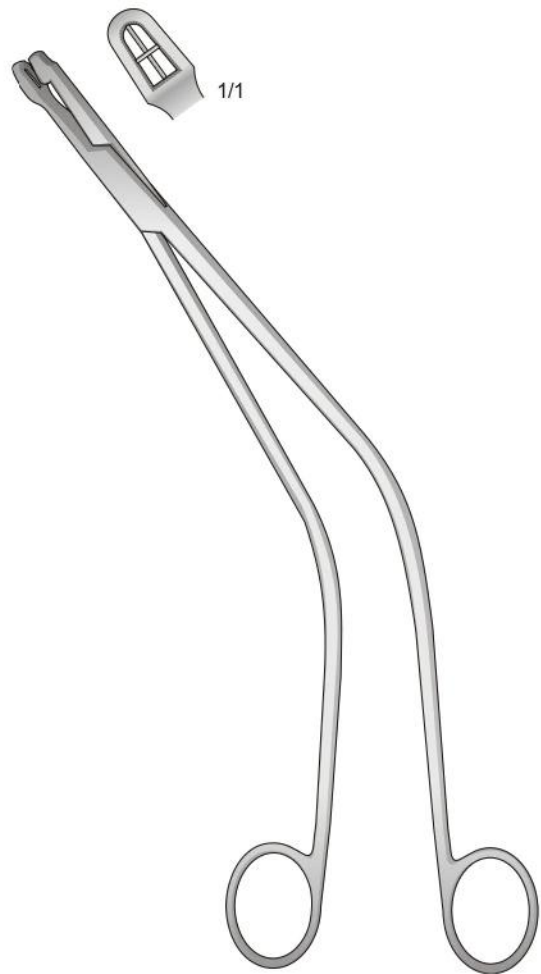

SCHUBERT
SSQ-7102
260 mm

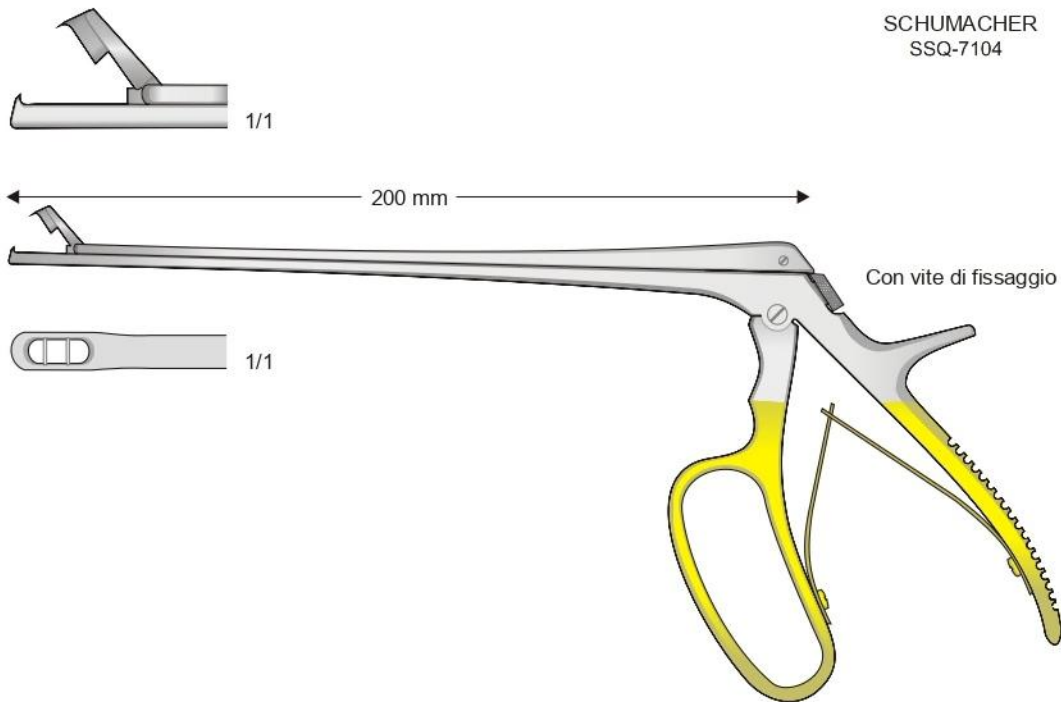
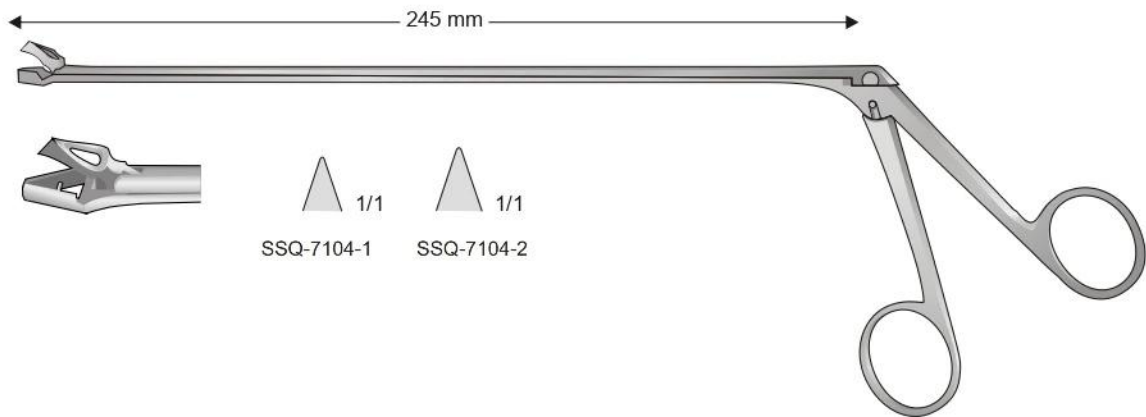
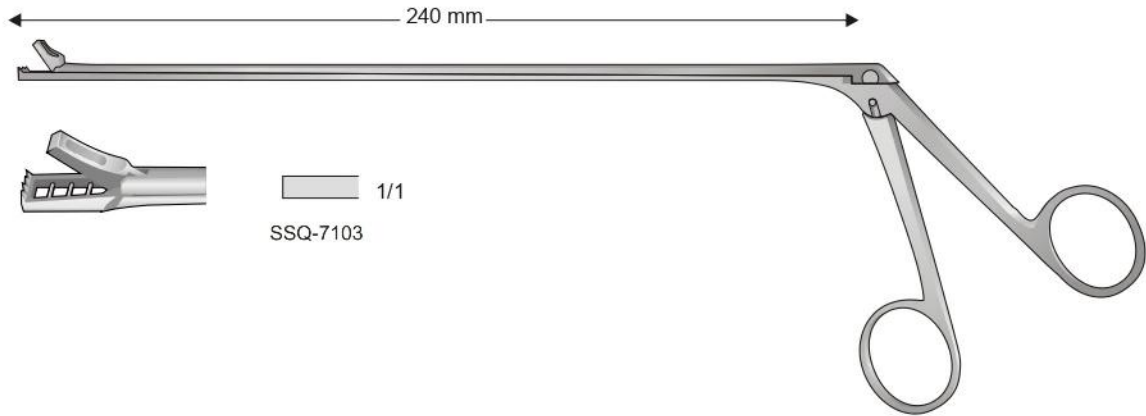

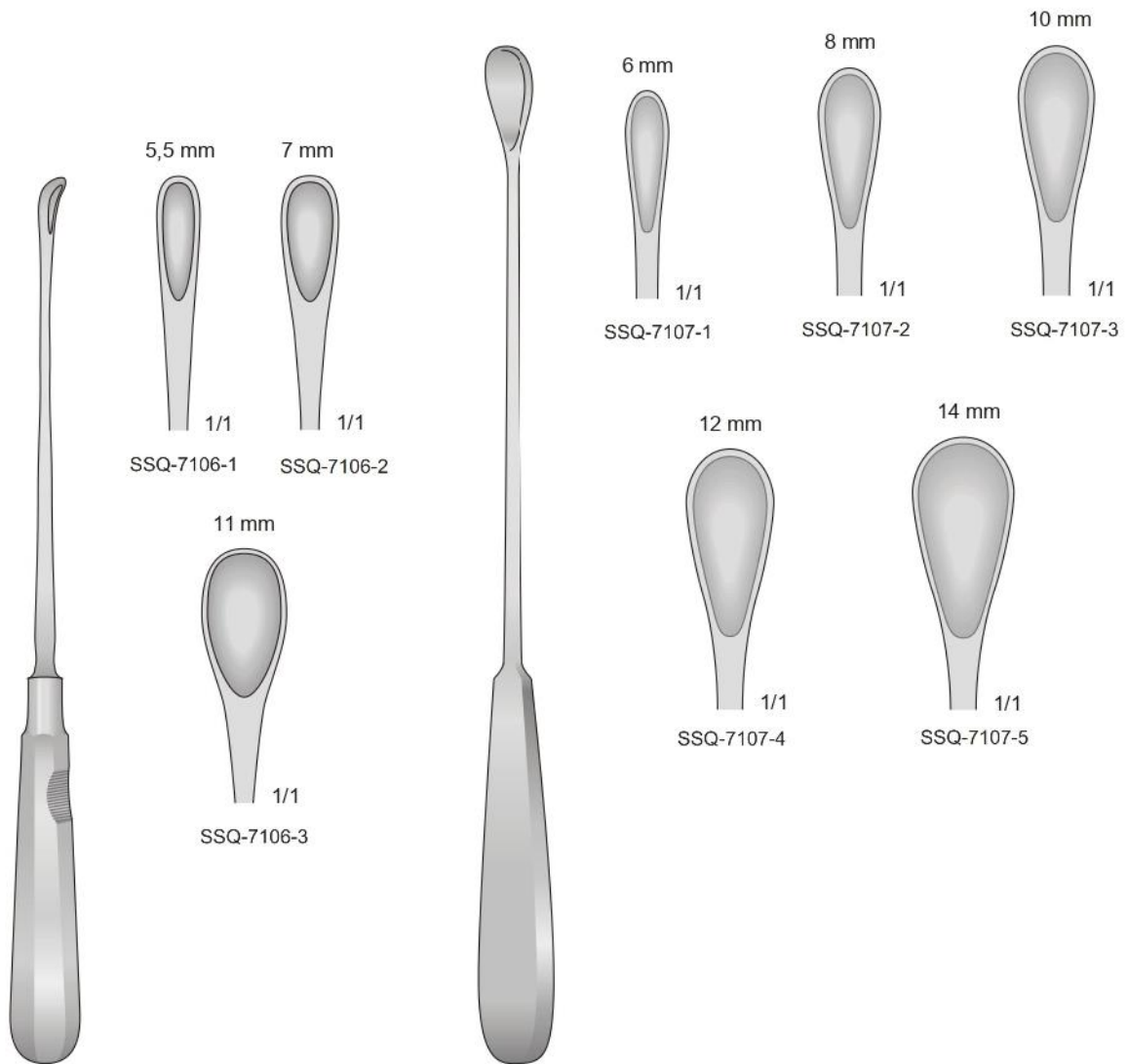

LUER-KÖRTE
SSQ-7106
260 mm

GOURDET
SSQ-7107
280 mm

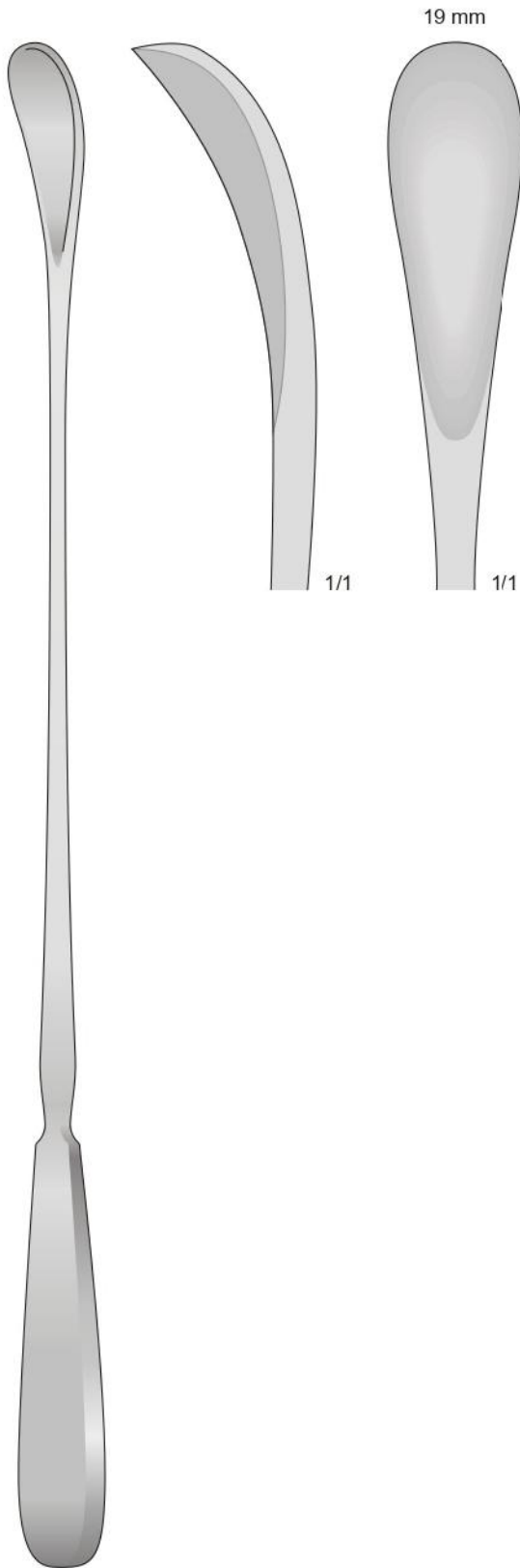

WALLICH
SSQ-7108
420 mm

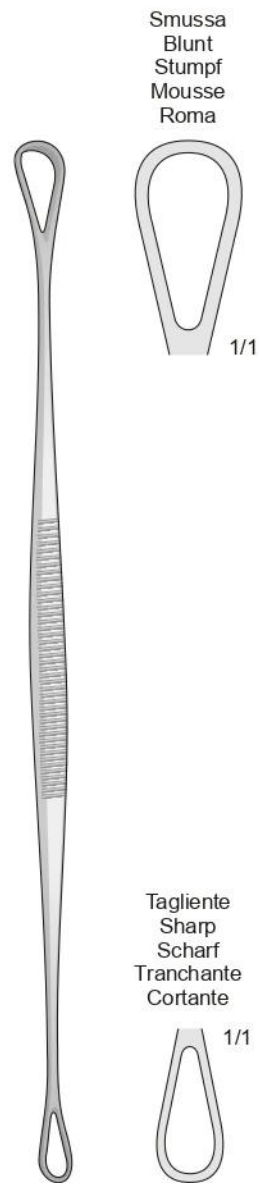

BLAKE
SSQ-7109
275 mm

Tagliente
Sharp
Scharf
Tranchante
Cortante

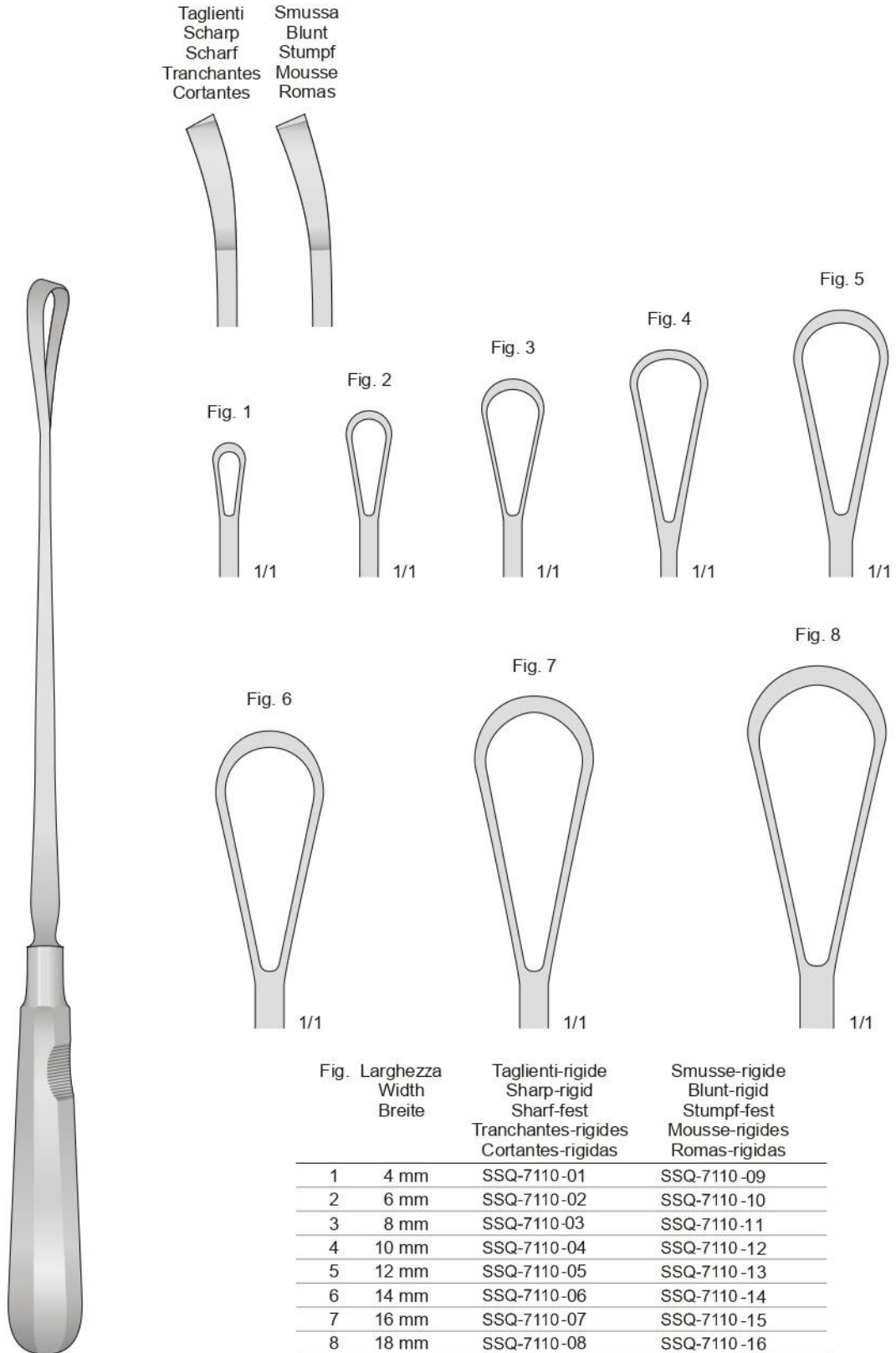

RECAMIER
SSQ-7110
310 mm

Fig.	Larghezza Width Breite	Taglienti-rigide Sharp-rigid Scharf-fest Tranchantes-rigides Cortantes-rigidas	Smusse-rigide Blunt-rigid Stumpf-fest Mousse-rigides Romas-rigidas
1	4 mm	SSQ-7110-01	SSQ-7110-09
2	6 mm	SSQ-7110-02	SSQ-7110-10
3	8 mm	SSQ-7110-03	SSQ-7110-11
4	10 mm	SSQ-7110-04	SSQ-7110-12
5	12 mm	SSQ-7110-05	SSQ-7110-13
6	14 mm	SSQ-7110-06	SSQ-7110-14
7	16 mm	SSQ-7110-07	SSQ-7110-15
8	18 mm	SSQ-7110-08	SSQ-7110-16

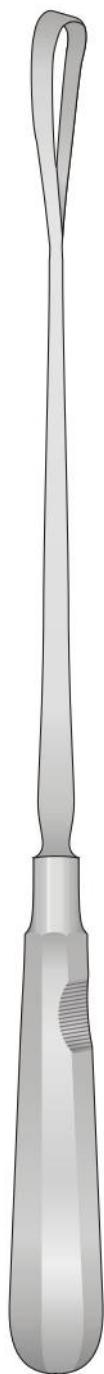

BUMM
SSQ-7111
310 mm

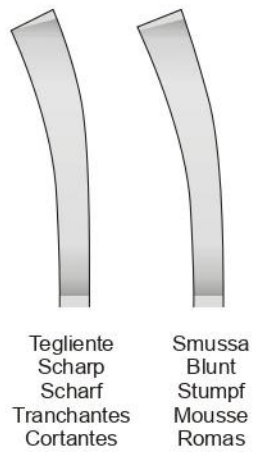

Tagliente
Scharp
Scharf
Tranchantes
Cortantes

Smussa
Blunt
Stumpf
Mousse
Romas

Malleabile
Malleable
Biegsam
Souples
Maleables

Fig. 3



Fig. 4

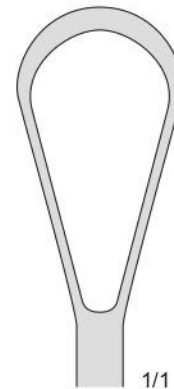

1/1

Fig.	Larghezza Width Breite	Taglienti Sharp Scharf Tranchantes Cortantes	Smusse Blunt Stumpf Mousse Romas
3	18 mm	SSQ-7111-1	SSQ-7111-3
4	20 mm	SSQ-7111-2	SSQ-7111-4

Fig.	Larghezza Breite Width	Smusse malleabili - Blunt malleable Stumpf biegsam - Mousse malleables Romos maleables
0	16 mm	SSQ-7112-01
1	18 mm	SSQ-7112-02
2	19,5 mm	SSQ-7112-03
3	21,5 mm	SSQ-7112-04
4	23,5 mm	SSQ-7112-05
5	26 mm	SSQ-7112-06
6	28,5 mm	SSQ-7112-07

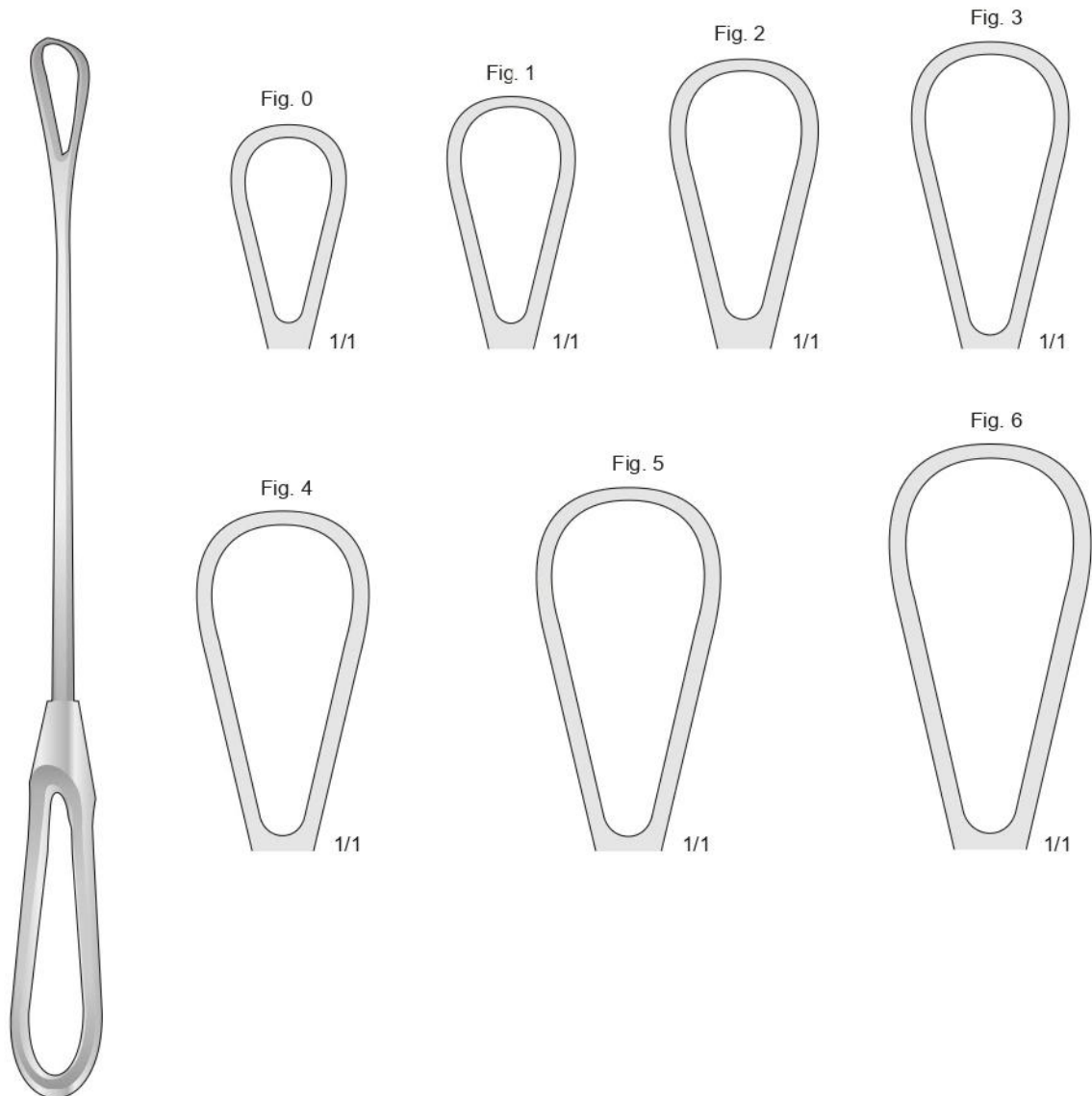

BUMM
SSQ-7112
290 mm

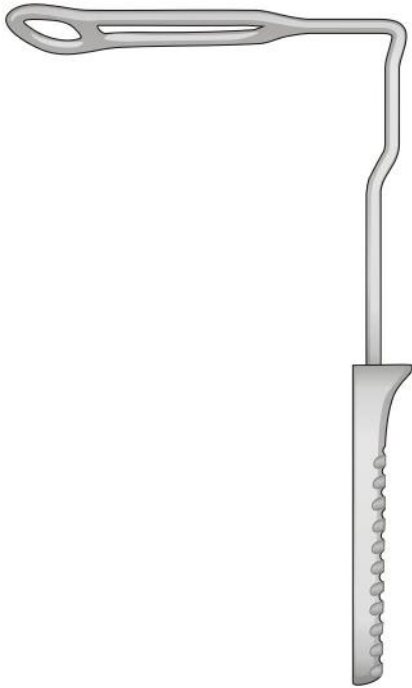

GENTOFT
SSQ-7113
210 mm

Set 2 pezzi
Set 2 pieces
Set 2 Stück
Set 2 pièces
Set 2 piezas
15-930



FENO
SSQ-7114
230 mm

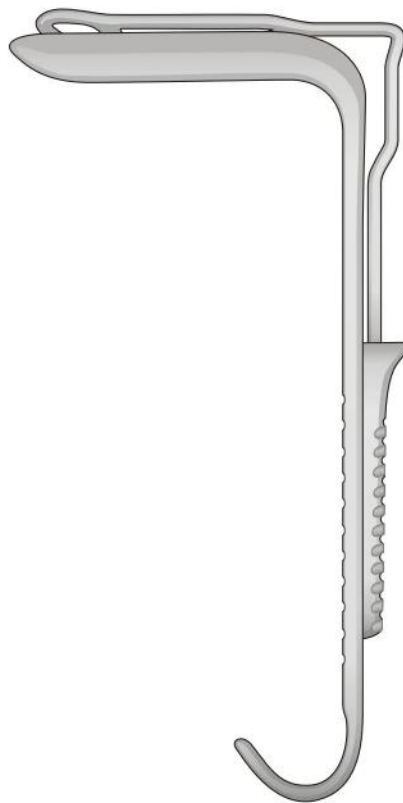

SSQ-7115
230 mm

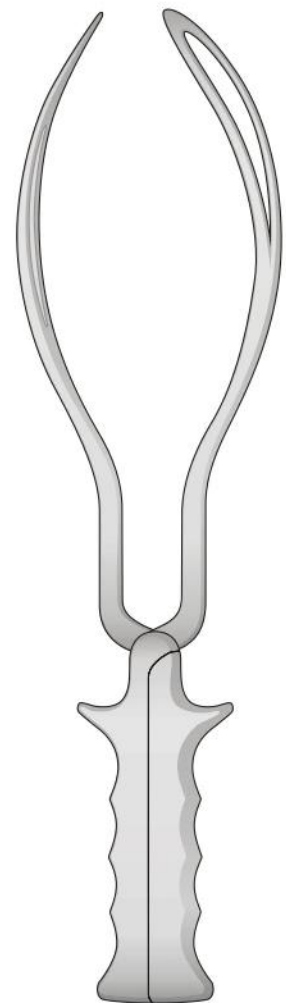

SIMPSON-BRAUN
SSQ-7116
365 mm



Manufacturer & Exporter Of Surgical Instruments.

- ☎ +92-52-3532361
- ☎ +92 (302) 775 4954 | +92 (301) 618 3770
- ✉ ssqintl1@gmail.com | info@ssqintl.com
- 📍 Kotli Loharan West, Near Chella, Sialkot - Pakistan



www.ssqintl.com